

UN/CEFACT Standards for International Supply Chain Semantic Harmonisation & Trade Facilitation

Sue Probert
UN/CEFACT Chair
suesiprobert@live.com

**Use of international standards for business to customs
information exchange**

UZBEKISTAN NATIONAL CAPACITY BUILDING SEMINAR

TASHKENT 29TH MARCH 2024



Partnerships and Collaboration



EC
DG-MOVE
DG-TAXUD
DG-MARE
DG-INTPA
DG-DIGIT
EEC
OECD

GS1
IPCSA
PROTECT
FIATA
SMDG
DCSA

ISO
IEC
ITU
WTO
ITC
IATA
WCO

UN / CEFACT

UN/CEFACT Reference Data Model Family

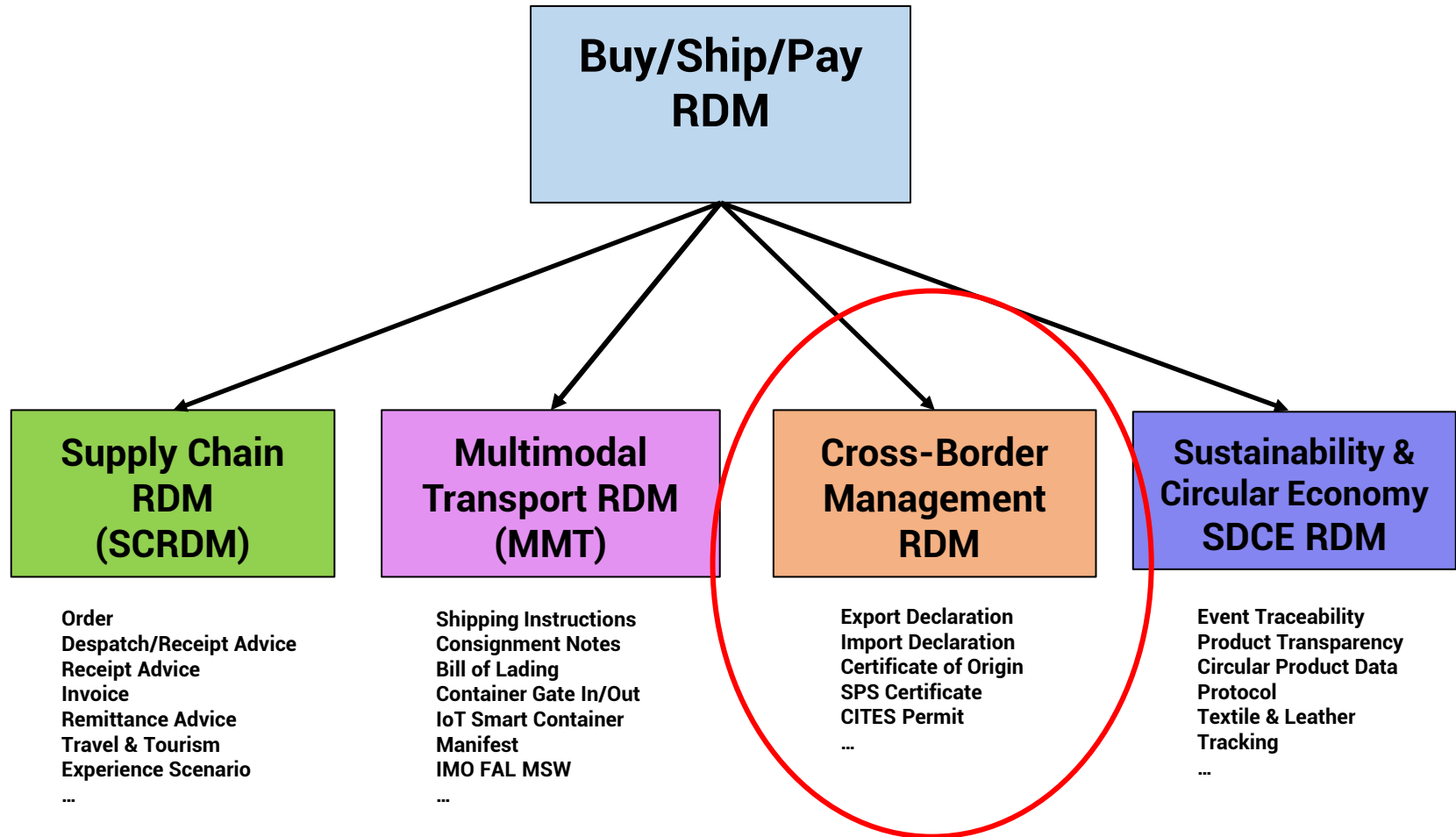

UN / CEFACT

Copyright UNECE

CBM RDM Project Purpose

Provide a Regulatory Reference Data Model based on the UN/CEFACT Buy/Ship/Pay Reference Data Model to:

- Assist cross-border agencies to link international supply chain B2B data to national or regional cross-border management data requirements
- Support pipeline data submission from trusted traders
- Complement harmoniously the existing RDMs for trade and transport

Considering:

- Trading Partner Collaboration
- Data Harmonisation and Rationalisation
- Alignment to Cross-Border Agency Regulations and Standards
- Semantic Mappings B2B ↔ B2G ↔ G2B ↔ G2G

<https://uncefact.unece.org/display/uncefactpublic/Cross-Border+Management+Reference+Data+Model>

Single Windows Document Families – Border Management Challenges

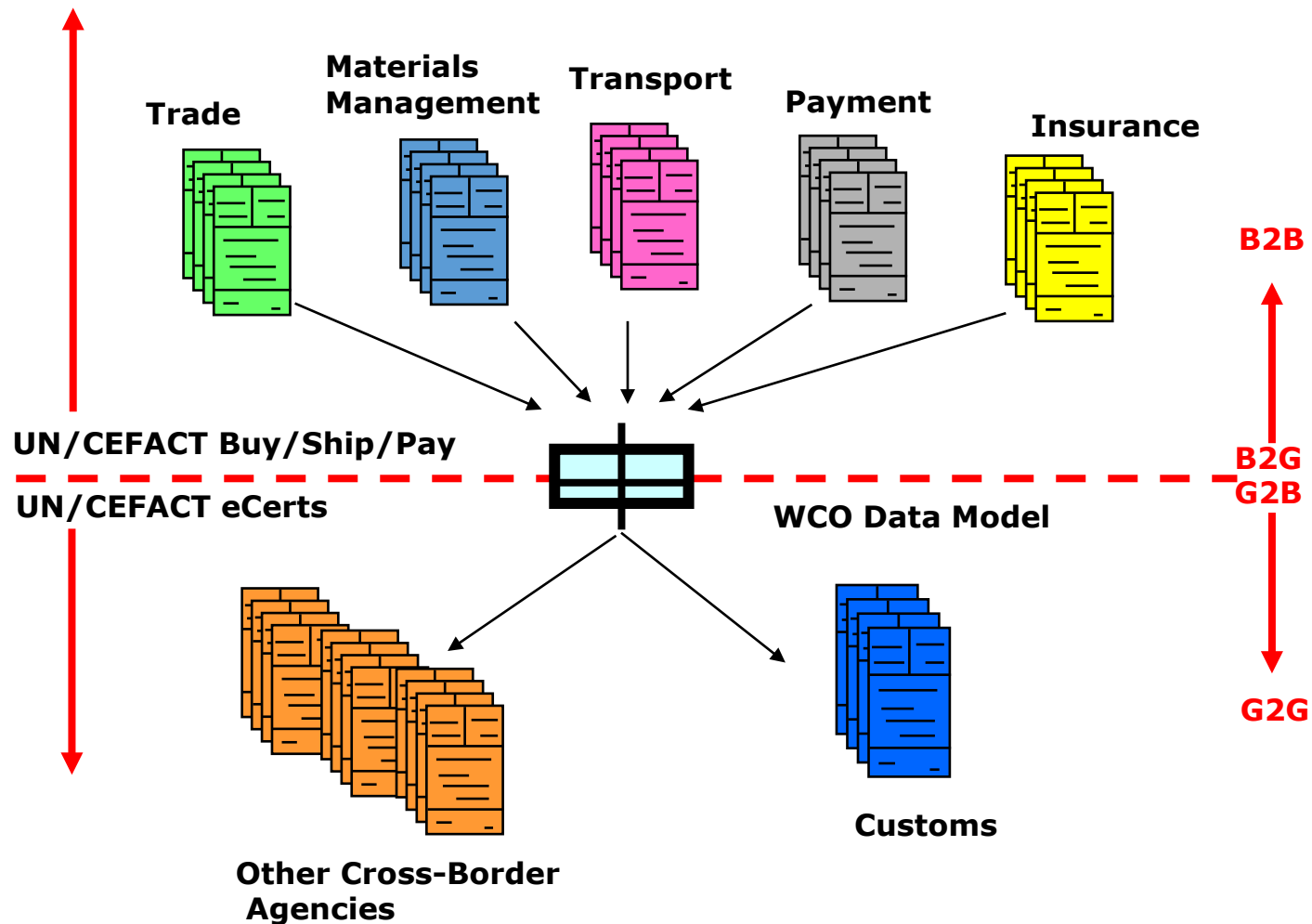



Key Single Window Semantic Aspects

- Public side and Government side speak different languages or, at least, different dialects
 - Affects names and definitions
 - Affects data quality
- Partnership approach using harmonised names and definitions will offer increased quality and mutually beneficial facilitation
- Pipeline provision of data in trusted trader programs
- Primary and Secondary data views
- Managing moving targets

Mapping between Supply Chain Reference Data Model (SCRDM) and WCO DM 3.11 – Trade View

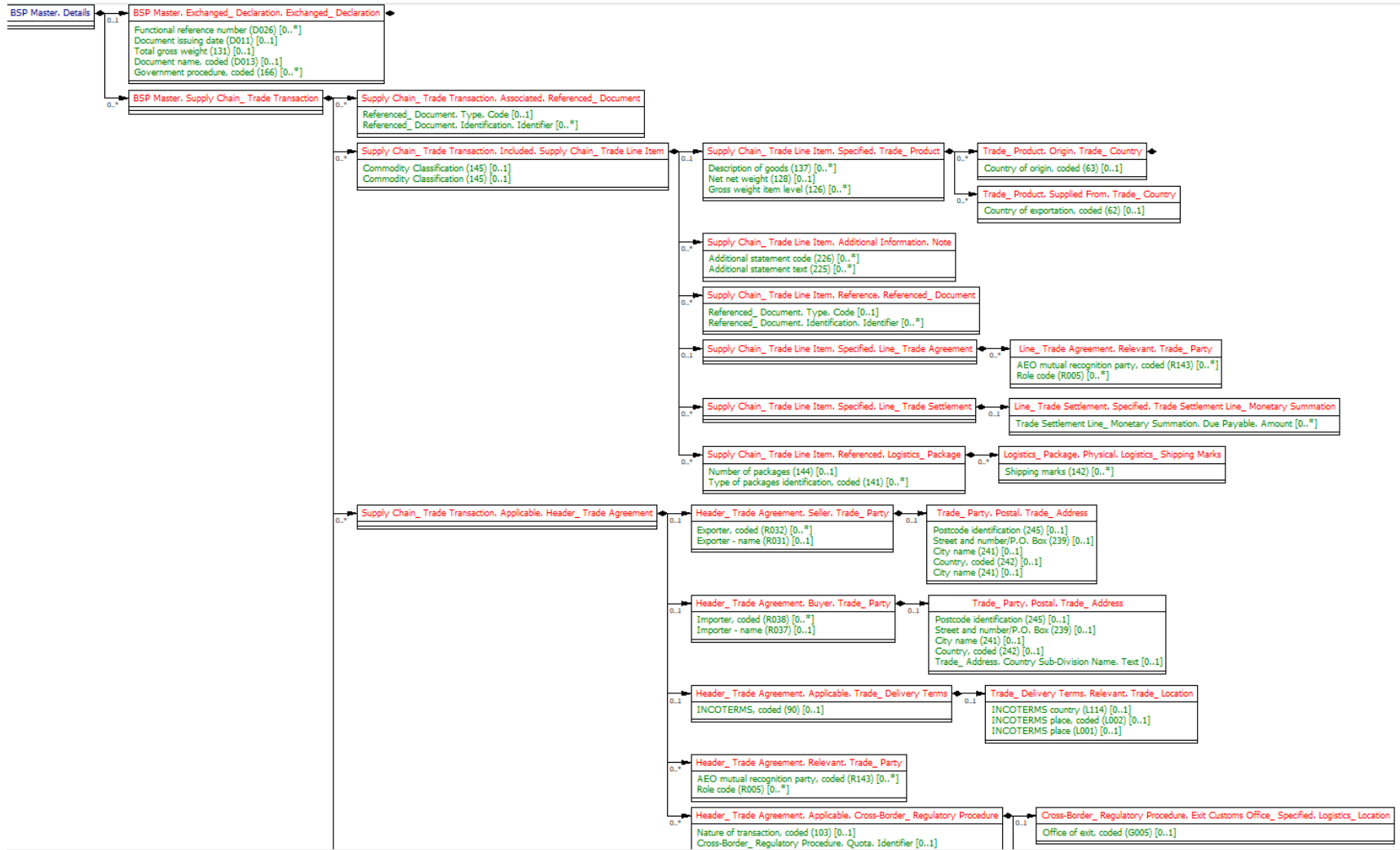

Mapping between Supply Chain Reference Data Model (SCRDM) and WCO DM 3.11 – Transport View

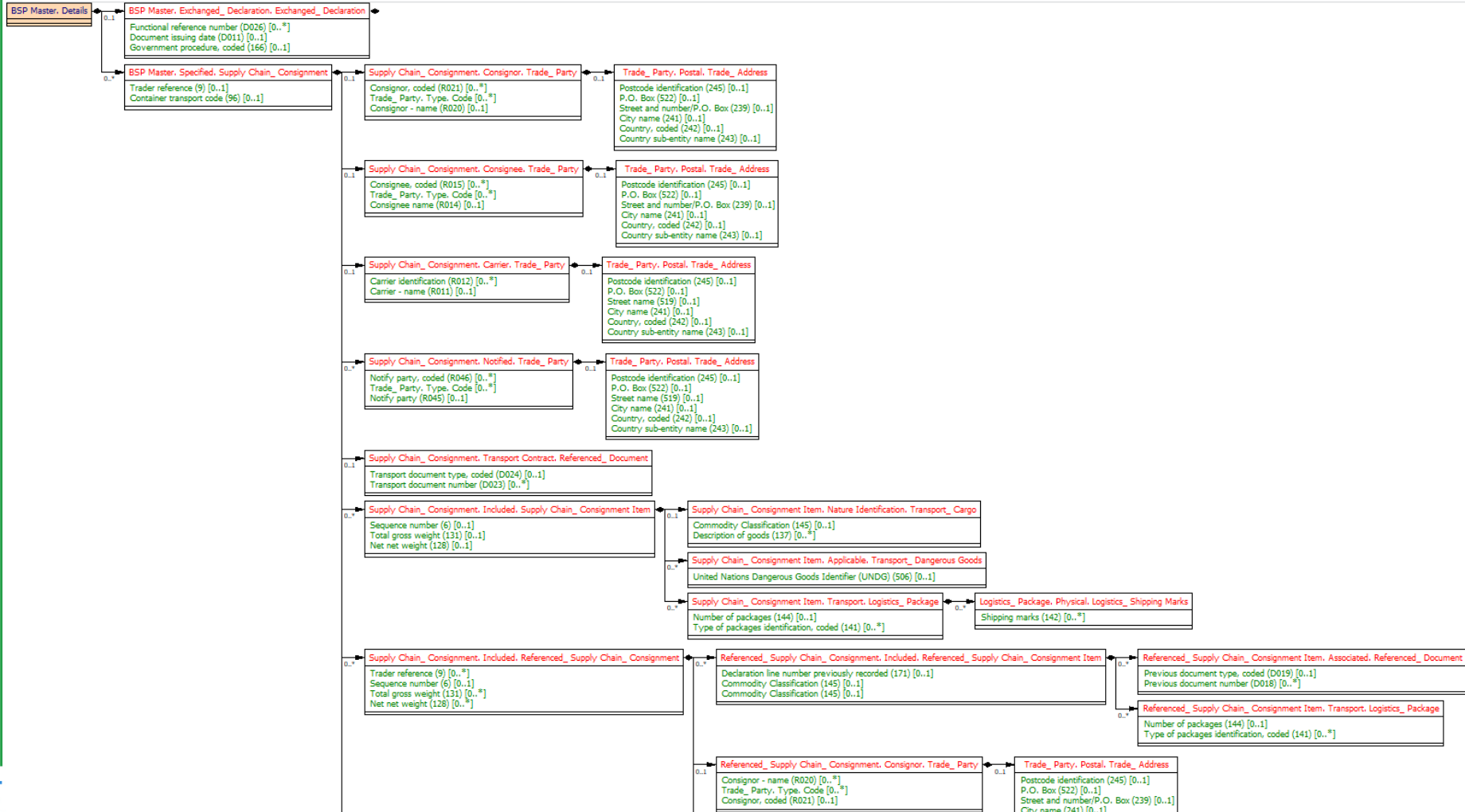

Customs View of trade and transport links (EU UCC)

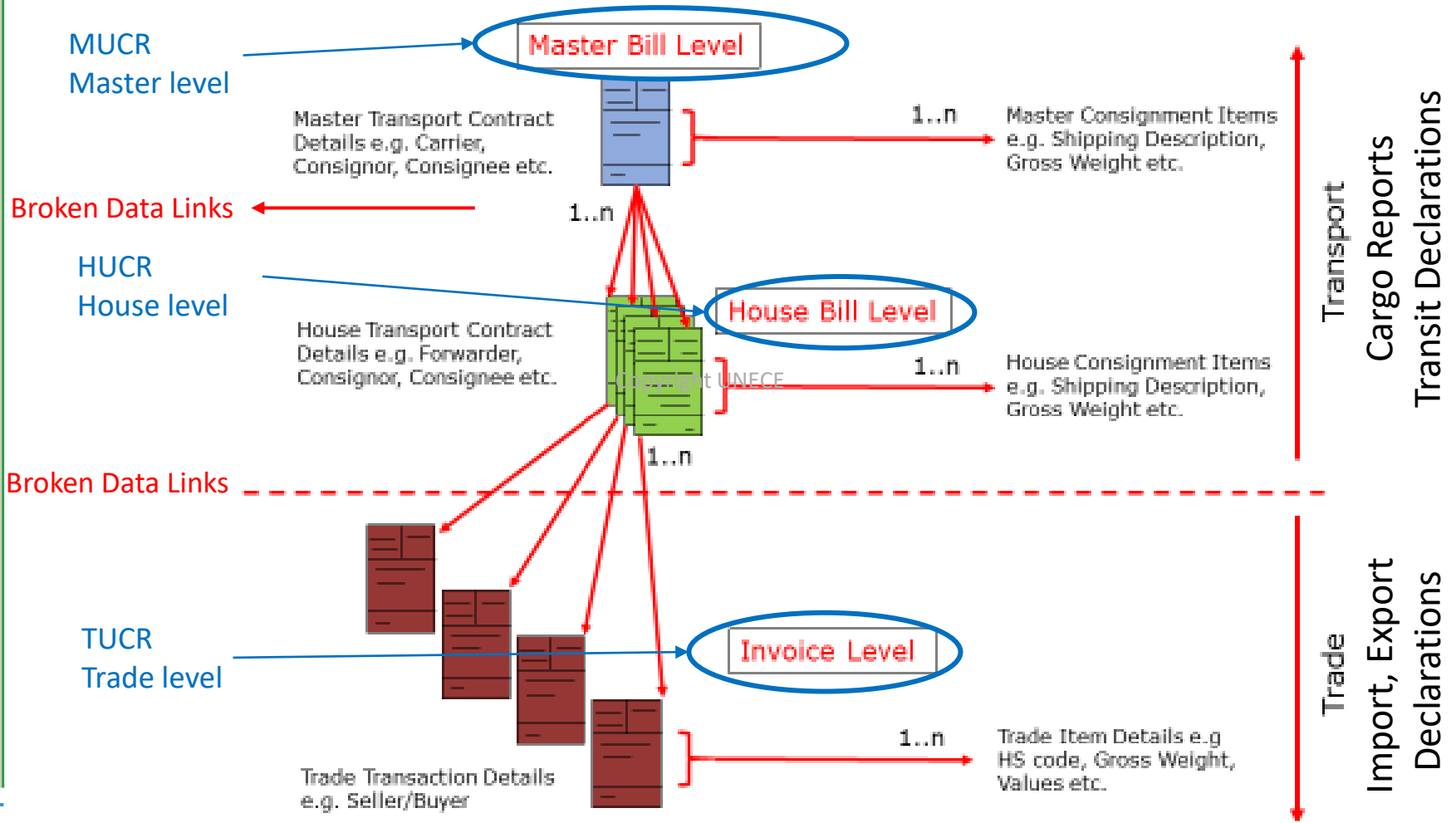

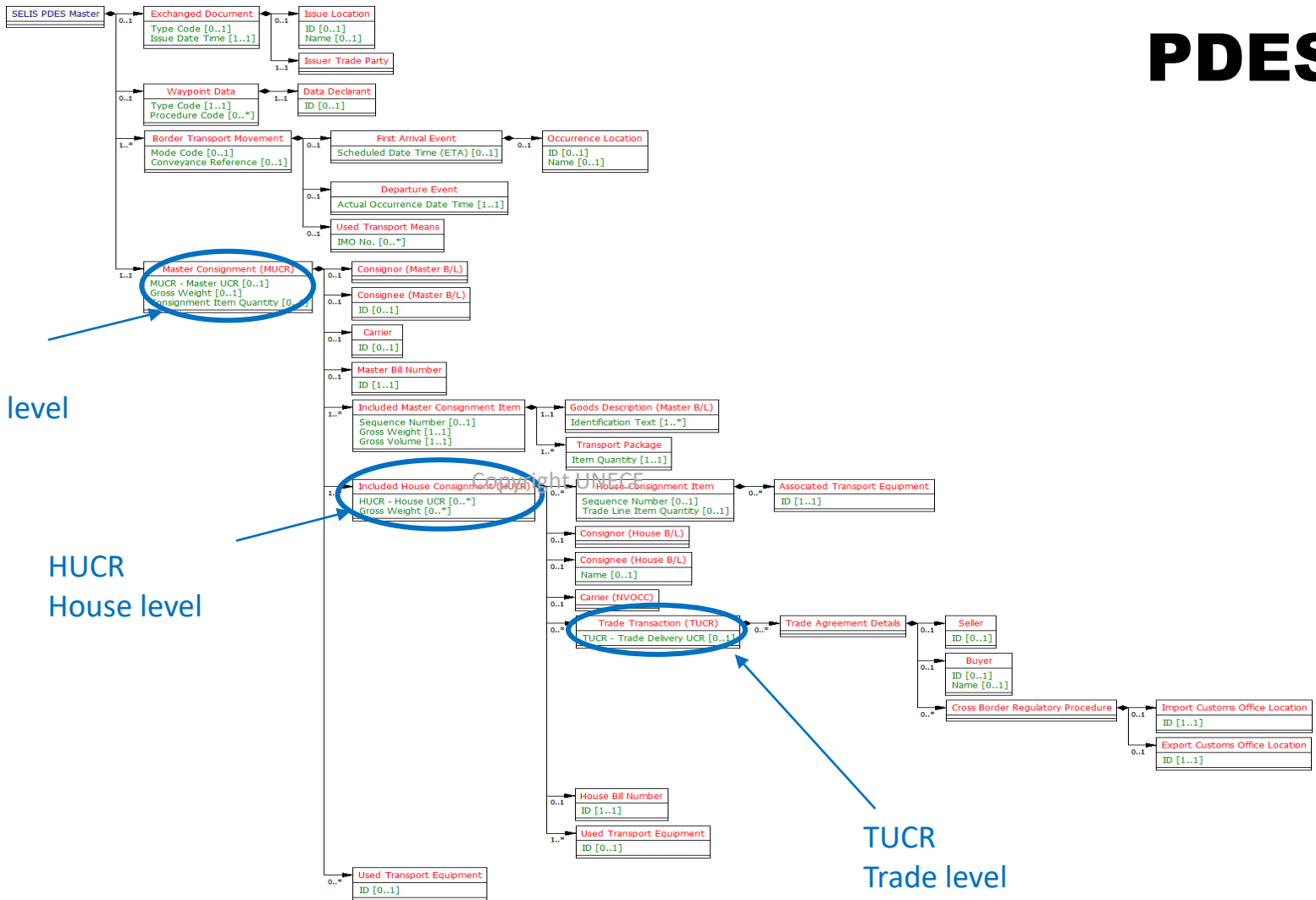

MUCR
Master level

HUCR
House level

TUCR
Trade level

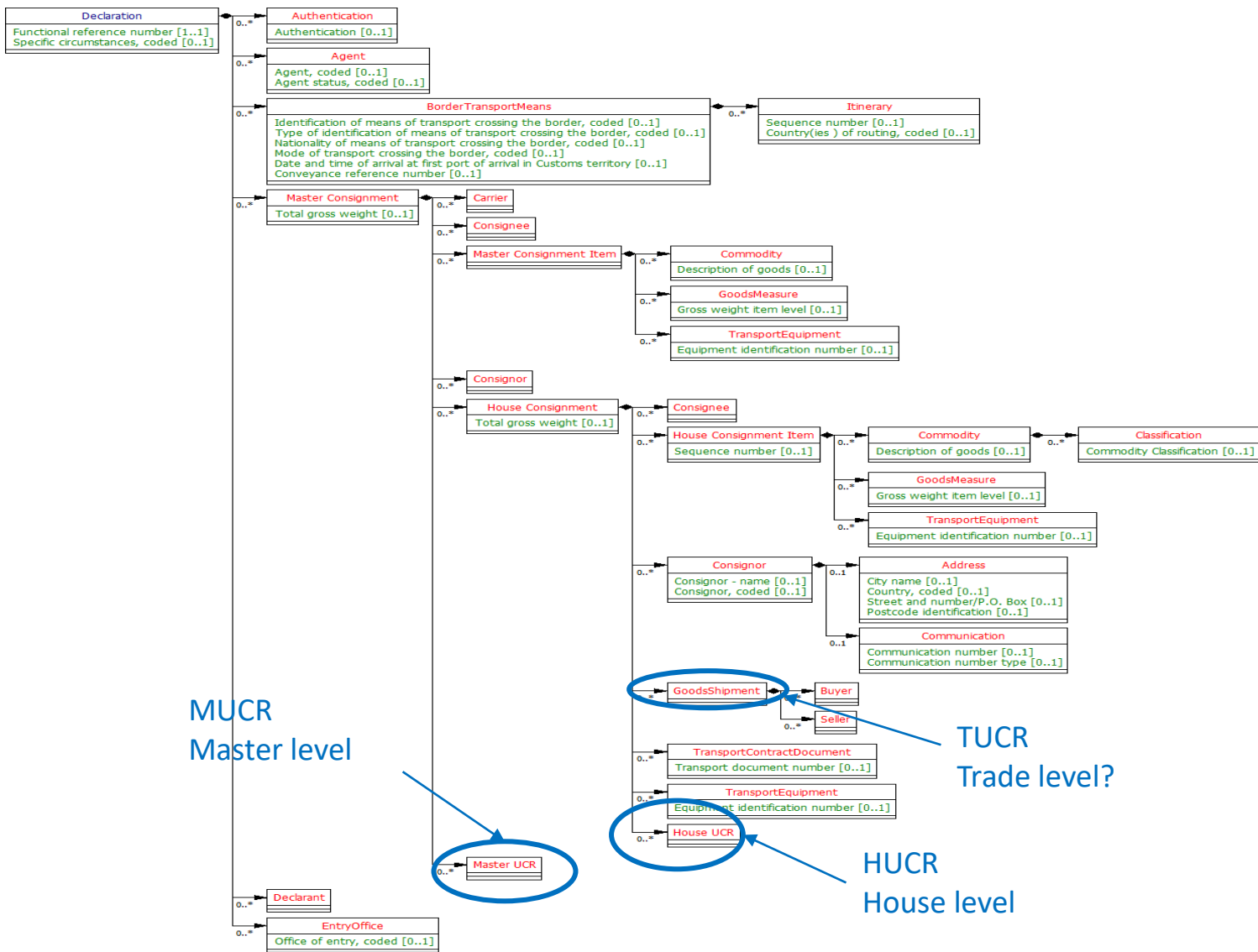

EUCDM analysis process and repository



1

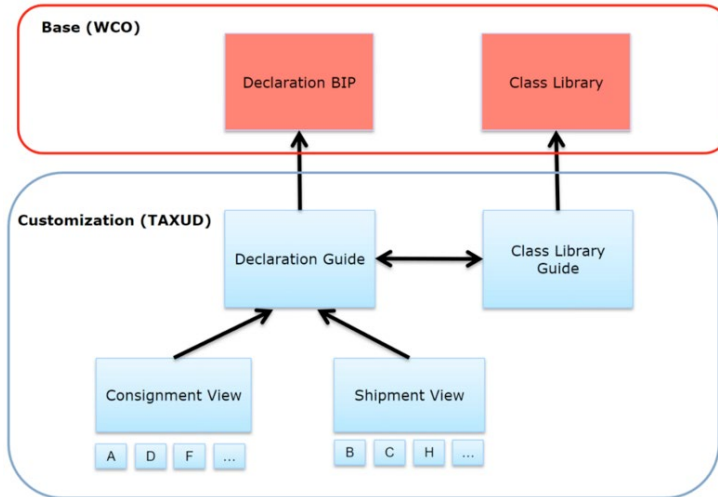

UCC Procedures (57)

- Exit
- Export
- Transit
- Proof of Union Status of goods
- Entry maritime transport (F10-F16)
- Entry air transport (F20-F29)
- Express consignments (F30-F33)
- Postal traffic (F40-F45)
- Road and Rail Traffic (F50-F51)
- Arrival Notification, Presentation Notification, Temporary Storage
- Import
- Import (Simplified Declaration; Entry into the Declarant's Records)

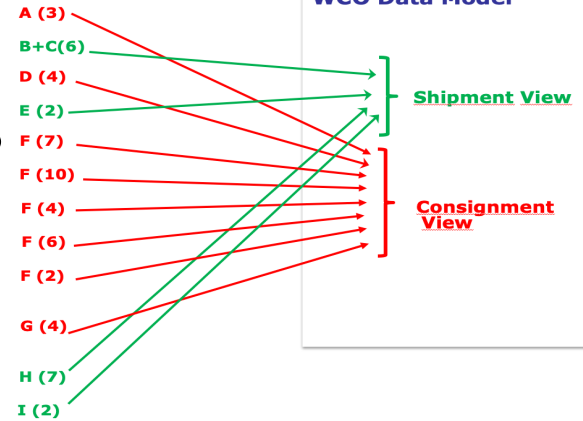

2

3

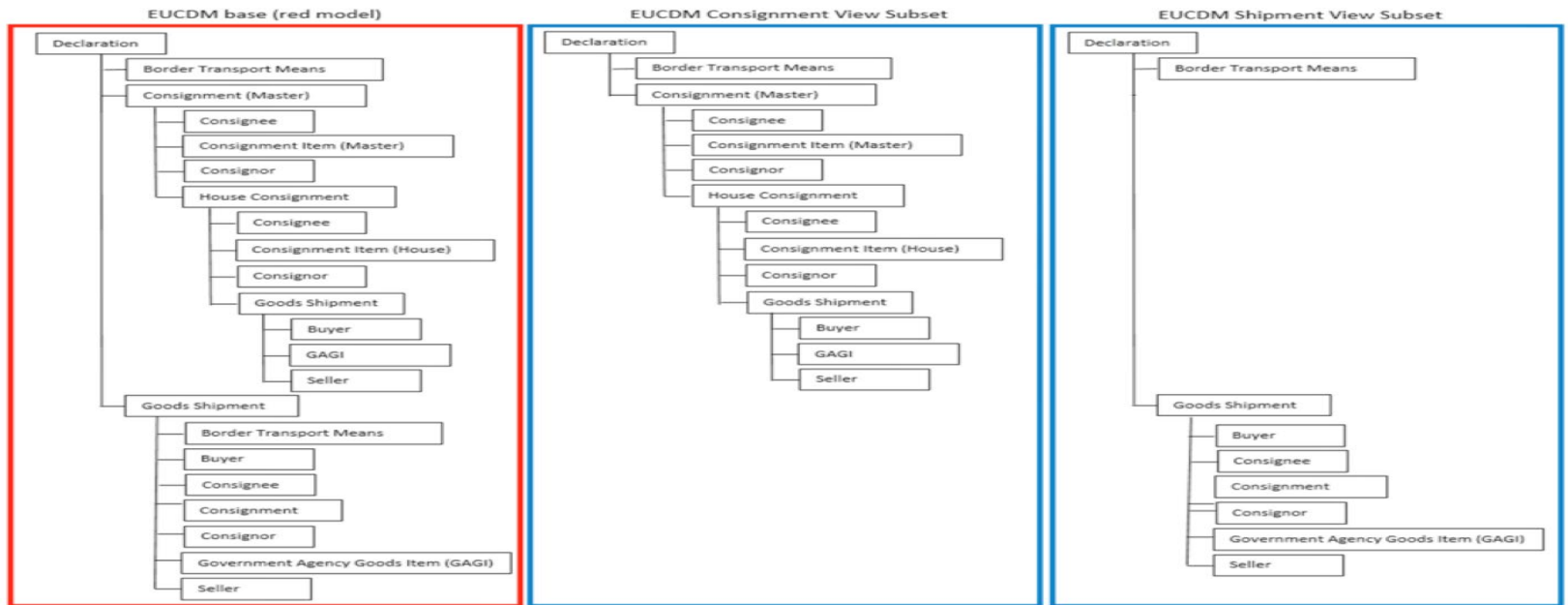

UN / CEFACT

EUCDM 6.2 Data Modelling Levels

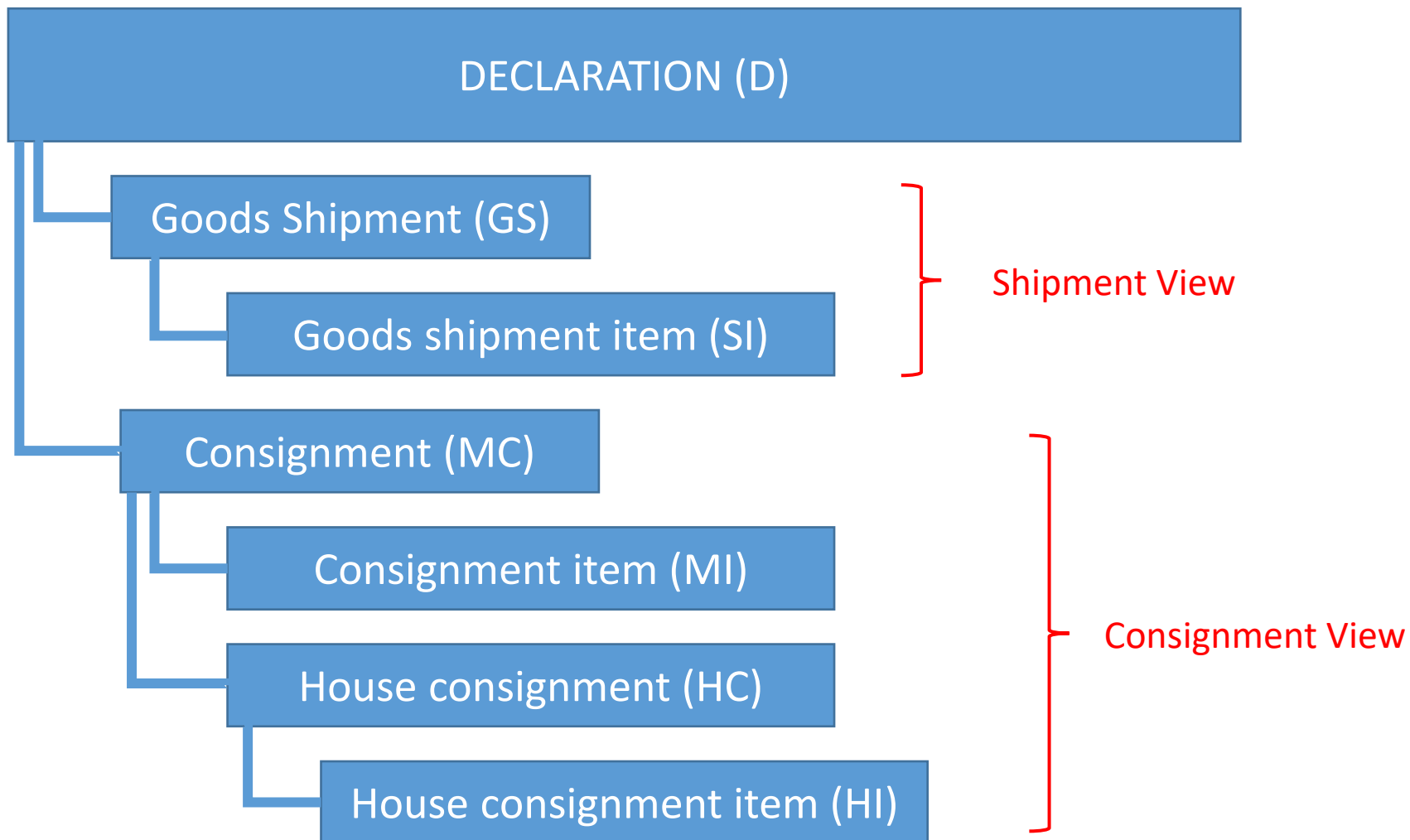

Global Trade – Trace & Track Project



Trade
B2B Data
World

Transport
B2B Data
World

