



Economic Commission for Europe**Inland Transport Committee****World Forum for Harmonization of Vehicle Regulations****Working Party on Pollution and Energy****Eighty-fifth session**

Geneva, 11-14 January 2022

**Report of the Working Party on Pollution and Energy
(GRPE) on its eighty-fifth session****Addendum 1****Adopted amendments to ECE/TRANS/WP.29/GRPE/2021/17**

The text reproduced below was adopted on the basis of ECE/TRANS/WP.29/GRPE/2021/17 amended by GRPE-85-04-Rev.1 (see para. 46. of the report) proposing a new Consolidated Resolution concerning Exhaust Ultra-Fine Particle Number Measurement For Heavy Duty Engines. This is a clean version. Changes from ECE/TRANS/WP.29/GRPE/2021/17 can be found in GRPE-84-04-Rev.1_track, available on the meeting webpage*.

* <https://unece.org/transport/documents/2021/12/informal-documents/track-pmp-proposed-amendments-ecetranswp29grpe202117>, accessed 10 February 2022



Proposal for a Consolidated Resolution on the exhaust ultra-fine particle number measurement for heavy duty engines

Contents

	<i>Page</i>
I. Statement of technical rationale and justification.....	3
A. Introduction	3
B. Procedural background	4
C. Existing regulations and standards.....	4
D. Technical rationale and justification.....	5
E. Technical feasibility, anticipated costs and benefits.....	8
F. Applying this consolidated resolution	8
II. Modifications to 07 series of amendments to UN Regulation No.49, as amended	9
Annex 4 – Test Procedure	9
Annex 4 – Appendix 8 - Particle number emissions measurement equipment	92

I. Statement of technical rationale and justification

A. Introduction

1. Since the inception of the Particle Measurement Programme (PMP) informal working group (IWG), the activities focused on development of an alternative metric with increased sensitivity compared to the existing Particulate Matter (PM) mass measurement system for Heavy Duty (HD) and Light Duty (LD) engines/vehicles (M and N category vehicles).
2. This phase concluded with the developed and adoption into UN Regulations Nos. 83 (emissions of M_1 and N_1 vehicles) and 49 (emissions of compression ignition and positive ignition (LPG and CNG) engines) of a solid particle number (SPN) counting method for ultrafine solid particles, together with enhancements to the PM measurement procedure for UN Regulation No. 83. Initially the SPN protocol was applied for diesel engines/vehicles only in the 06 series of amendments to UN Regulation No. 83 and 06 series of amendments to UN Regulation No. 49 and subsequently has been extended to cover vehicles using spark ignition direct injection engines in the 06 series of amendments to UN Regulation No. 83.
3. The European Union (EU) and Switzerland requested in 2013 further investigation of particle number emissions from spark ignition engines relating to particle size and to emissions under rich operation conditions. As follow-up of this request, the IWG on PMP monitored particle emissions from a large variety of LD engine technologies. The attention has been mainly focussed on the difference between the number of particles measured with the existing PMP methodology (50 per cent counting efficiency (d50) around 23 nm) and with systems with lower d50s. The fraction of particles emitted by the monitored engines not captured/counted by the existing PMP methodology was found to be extremely variable and depending on the engine technology as well as on the d50 considered. The legislative methodology with a d50=23 nm (SPN23) appeared to be still suitable for current engine technologies to which the SPN limit is applicable (i.e. diesel and G-DI), since high emitters were still unequivocally detected. However, there is evidence that specific technologies like PFI and CNG engines may exhibit, in some cases, particle emissions close to the existing emission limit and at the same time a significantly high fraction of sub-23 nm particles and even sub-10 nm particles.
4. In view of a possible extension of the particle number limit to all combustion engines, the European Commission and other Contracting Parties had expressed the interest in a test procedure with a lower cut-off size in order to improve the control of particle emissions whatever the average size of the particles emitted. The IWG on PMP concluded that it would be extremely challenging to develop a reliable particle counting methodology with a d50 below 10 nm while a 50 per cent cut-off size at around 10 nm (SPN10) would be achievable by properly adapting the existing methodology.
5. IWG on PMP identified the necessary changes which would allow an increase to the size range of the particles counted, whilst maintaining an appropriate level of repeatability/reproducibility, and at the same time minimize the impact on the testing burden and the measuring equipment required. The new proposed procedure has been assessed by means of an inter-laboratory exercise that has involved several laboratories located in Europe and Asia. This exercise has shown that the variability level of SPN10 results is at the same level as the SPN23 values.
6. The identified changes have been submitted to GRPE in June 2020 as an amendment to the SPN measurement procedure laid down in UN GTR No. 15 for LD vehicles. Since a few Contracting Parties had asked to maintain the existing methodology with the 50 per cent cut-off size at 23 nm, in the amended UN GTR No. 15, in agreement with the GRPE Secretariat, it was decided to keep the existing methodology and introduce the new procedure with the cut-off size at 10 nm as an additional option.
7. The PMP then focused its activity on the extension of the new procedure with the reduced cut-off to HD engines. The decision for such extension stemmed mainly from the evidence that CNG (compressed natural gas) fuelled HD engines may exhibit, in some cases, particle emissions close to the existing emission limit and at the same time a significantly

high fraction of sub-23 nm particles. For this reason, the PMP group has identified the changes to the SPN measurement procedure laid down in UN Regulation No. 49 needed to reduce the cut-off size to 10 nm. The changes are basically the same already introduced in UN GTR No. 15 for LD vehicles.

7. Moreover, an additional sampling option for measuring particle number emission was assessed by the PMP group. The SPN measurement procedure laid down in UN Regulation No. 49 allows sampling the diluted exhaust gas either from the total flow dilution tunnel or from proportional partial flow dilution systems. In order to reduce the testing burden, some parties have asked to introduce the sampling for raw exhaust gas via a fixed dilution as an additional option. Both the changes to reduce the cut-off size to 10 nm and the alternative sampling method have been assessed by means of an international testing programme carried out by laboratories located in Europe and Asia.

8. Since the SPN measurement procedure for HD engines is described only in UN Regulation No. 49 and in UN GTR No. 4 and due to the fact that the post-Euro VI standard are still being developed in Europe, the European Commission asked not to submit the new procedure as an amendment to UN Regulation No. 49. Any decision on when and how the new procedure will be included in a regulatory act will be therefore taken at a later stage.

9. This Consolidated Resolution describes the new SPN measurement procedure for HD engines including the sub-23 nm as well as the raw exhaust sampling options. The new Resolution provides therefore the update the SPN measurement procedure for HD engines to all the Contracting Parties that could have an interest in doing that.

B. Procedural background

10. At its 81st June 2020 session, GRPE endorsed the new ToR of the IWG on PMP which contained a deliverable on "Submissions of an informal proposal for HD raw exhaust SPN sampling and extension of sub-23 nm procedure to HD engines: January 2021"

11. The IWG on PMP developed the above proposal and submitted it to GRPE in the 82nd January 2021 session as an informal document for consideration of the Contracting Parties.

12. The Consolidated Resolution (R.E. [X[†]]) provides the provisions for the measurement of particle number emissions from HD engines.

C. Existing regulations and standards

12. Many countries throughout the world have already introduced standards concerning particle emissions from engines. As a consequence of the intention of several countries to extend the SPN emission standards to all the combustion engines, the procedure needed to be modified to adapt the cut-off size to cover other applications in addition to diesel engines.

13. For LD vehicles, the SPN measurement procedure is described both in the UN Regulation No. 83 and in the UN GTR No. 15. The UN GTR No. 15 has been amended in the WP.29 November 2020 session [ECE/TRANS/WP.29/2020/128 - (GRPE) - Technical Report on the development of Amendment 6 to UN GTR No. 15 (Worldwide harmonized Light vehicles Test Procedures (WLTP)]. This amendment included the additional option for the SPN measurement with a cut-off size at 10 nm and few other modifications to improve the procedure itself.

14. The SPN measurement procedure for HD engines is described only in the UN Regulation No. 49 and not in the UN GTR No. 4. For this reason, it was not possible to submit the new procedure as an amendment to UN GTR No. 4.

[†] To be replaced once number determined

D. Technical rationale and justification

15. This section introduces the main modifications to the procedure described in UN Regulation No. 49 in order to introduce two additional options. The first is the option to measure SPN with a cut-off size at 10 nm while the second is the possibility to sample from raw exhaust via a fixed dilution ratio.

1. 10 nm cut-off size particle measurement option

16. One of the most debated points in the IWG on PMP concerned the volatile particle remover and more specifically whether for SPN10 this should be based on a catalytic stripper or whether also the usual evaporation tube should be allowed. The results of the light-duty inter-laboratory correlation exercise did not provide clear evidence that one solution is definitely better than the other. The heavy-duty inter-laboratory comparison exercise showed that there could be cases that the catalytic stripper was more efficient in removing the volatile particles (e.g. during regenerations). A review of methods removing volatiles concluded that the catalytic stripper was more efficient than the evaporation tube, especially when sulphuric acid was present in the exhaust. For these reasons it was decided to allow only the use of the catalytic stripper for SPN10 (recommended system).

17. However, in order to maintain the possibility of using sampling systems designed for SPN10 also for SPN23 measurement, the IWG proposed to modify also the existing procedure by removing the restriction that the sampling system parts shall not react with the exhaust gas components. In this way a sampling system with a catalytic stripper fitted with a condensation particle counter with the proper calibration can be used for the SPN23 measurement. As supported by several experimental data, the different losses between catalytic stripper and evaporation tube become important only below 23 nm and therefore, allowing the use of both devices for SPN23, should not result in an increased variability of the measurements.

18. Table 1 summarizes the main changes to the procedure laid down in UN Regulation No. 49, subject of this Consolidated Resolution.

Table 1

Main changes to SPN23 and changes/additions for SPN10

<i>Subject</i>	<i>Annex 4 to UN Regulation No. 49, as in the 07 series of amendments</i>	<i>Proposed changes for SPN23</i>	<i>Proposed changes for SPN10</i>	<i>Reasoning</i>
PNC efficiency	50±12 % @ 23 nm, >90% @ 41nm	None	65±15 % @ 10 nm, >90% @ 15nm	Typical PNC-efficiency, well tested in the field.
Maximum VPR-loss requirement	@ 30nm 30% and @ 50 nm 20% higher than @ 100 nm	None	Addition @15 nm 100 % higher than at 100 nm	No additional requirement below 15 nm since generation of particles < 15 nm challenging, uncertainties high
Polydisperse validation of VPR	a polydisperse 50 nm aerosol may be used for validation	None	Removed	Uncertainties @ 15 nm or below high → test serves no purpose
VPR validation	> 99.0 % vaporization of 30 nm tetracontane particles, with an	None	> 99.9 % removal efficiency of tetracontane particles with	Secure the functioning of VPR also for PNC with 65±15

<i>Subject</i>	<i>Annex 4 to UN Regulation No. 49, as in the 07 series of amendments</i>	<i>Proposed changes for SPN23</i>	<i>Proposed changes for SPN10</i>	<i>Reasoning</i>
	inlet concentration of $\geq 10,000$ per cm^3 (Monodisperse)		count median diameter > 50 nm and mass $> 1 \text{ mg/m}^3$. (Polydisperse)	% @ 10 nm, $>90\%$ @ 15nm
Volatile Particle Remover (VPR)	All parts (of SPN-system) -- shall not react with exhaust gas components	-- VPR may be catalyzed (both heated evaporation tube and catalytic stripper allowed)	- the VPR shall be catalyzed (use of catalytic stripper only) (recommended system)	Minimize the risk of artefacts for SPN10. Comparability of PN10 and PN23 and possibility of using new sampling systems with CS also for SPN23 by fitting a PNC with a d_{50} @ 23 nm.

CS=Catalytic Stripper; PNC=Particle Number Counter; SPN=Solid Particle Number; VPR=Volatile Particle Remover

2. Purpose and summary of the direct SPN tailpipe measurements with fixed dilution option

19. The modifications introduced to UN Regulation No. 49 aims mainly at introducing as an alternative option the possibility to measure solid particle number (SPN) directly from the tailpipe with fixed dilution, in addition to the currently allowed options of measuring from a proportional partial flow system or the full dilution tunnel.

20. This amendment stems from the need of simpler procedures that need less space and do not require the use of a partial or full flow dilution system. Direct tailpipe sampling of gaseous pollutants is allowed in the heavy-duty engines regulations, thus permitting SPN measurements is a natural consequence. Particles however can be lost or transformed in the sampling lines, thus special attention is needed for the sampling conditions. Based on the experience with light-duty SPN measurements from the tailpipe, portable emission measurement systems for light-duty and heavy-duty vehicles, it was assumed that SPN measurements directly from the tailpipe with fixed dilution would be feasible for type approval of heavy-duty engines. The two possible approaches are: Direct hot dilution with existing PMP systems or use of a cold pre-diluter, both with fixed dilution ratio.

21. An inter-laboratory exercise was conducted in Europe, where a "Golden" system measuring directly from the tailpipe with "hot" (150°C) fixed dilution was compared with the laboratory regulated systems. The results of the "Golden" instruments were within 25 per cent in most cases, reaching 40 per cent in two laboratories for both >23 nm and >10 nm. The repeatability of the measurements (10 per cent to 40 per cent) remained the same for both systems with both cut-off sizes. Another system measuring from the tailpipe with a fixed "cold" (at ambient temperature) dilution gave differences of up to 50 per cent in most cases (on average +26 per cent). Dedicated tests with this system showed that the differences were the same with fixed or proportional dilution, indicating that it is not the concept that resulted in the overestimation, but the calibration of the system. Tests in China with China II-VI engines with the same "Golden" system revealed differences on average of -25 per cent (tailpipe system lower) for both >23 nm and >10 nm systems compared to a full dilution tunnel. Additional tests in Europe found -25 per cent difference of the tailpipe system with "hot" dilution, and +25 per cent of the tailpipe system with "cold" dilution compared to the reference system (proportional partial flow system).

22. Table 2 summarizes the major additions for the new option of direct SPN sampling from the tailpipe with fixed dilution. The major was the technical requirements for the “cold” pre-diluter, whenever used.

Table 2

Main additions the procedure laid down in UN Regulation No. 49 for direct SPN sampling

<i>Subject</i>	<i>Proposed changes for direct SPN sampling with fixed dilution ratio</i>	<i>Reasoning</i>
Pre-diluter	A cold or hot pre-diluter may be located at the end of the particle sampling probe and in front of the PTT. A fixed dilution ratio >5:1 shall be applied to the cold or hot dilution stage. Cold dilution is defined as a dilution with (unheated) dilution air and/or diluter temperature $\geq 20^{\circ}\text{C}$.	Cold dilution similar to proportional partial flow system's should be acceptable
Losses	The penetration for each model of pre-diluter shall be determined as described in paragraph A.8.2.2.4 separately or in combination with the VPR. The final system penetration (pre-diluter, PTT and VPR) shall not decrease 10 per cent the requirements of paragraph A.8.1.3.3.6. The particle concentration reduction factors of each pre-diluter shall be determined as described in paragraph A.8.2.2.2 separately or in combination with the VPR and shall be taken into account in the calculation of the emissions. The complete system (pre-diluter, PTT and VPR) shall not exceed 0 per cent for 50 nm, 10 per cent for 30 nm, and 25 per cent for 15 nm (if applicable) the fr(di)/fr(100) ratio requirements of paragraph A.8.1.3.3.4.	The pre-diluter needs to be characterised
Sampling line	When sampling directly from the tailpipe the residence time until the pre-diluter or the VPR shall be ≤ 1 seconds. The tubing shall be heated at $\geq 150^{\circ}\text{C}$ if ≥ 10 cm. Good engineering judgment should be applied to minimise particle losses and insulate unheated parts.	Reduced residence time, hot sampling line to avoid condensation and minimise particle losses

Examples of different SPN sampling configurations:

From proportional partial flow system

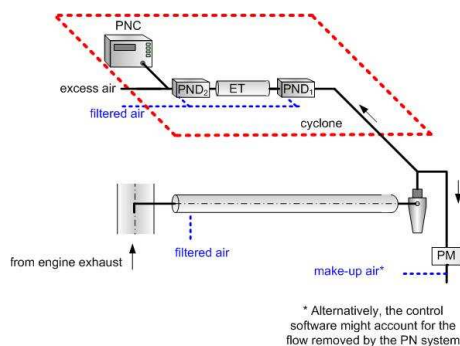

From dilution tunnel

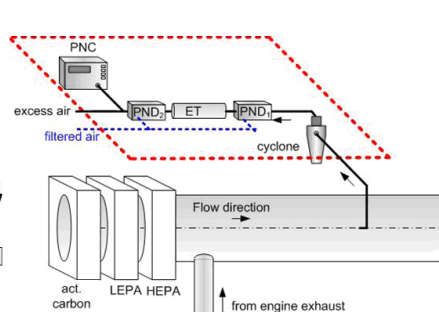

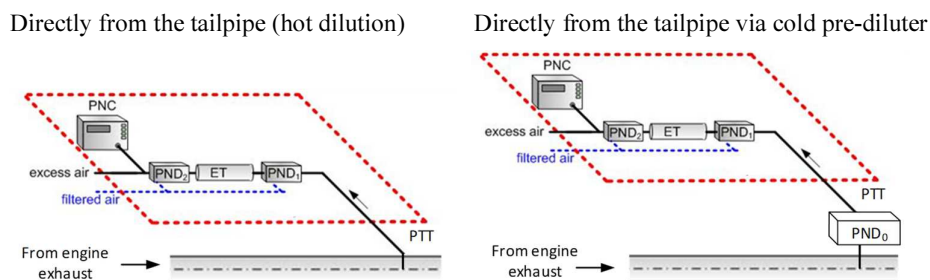

E. Technical feasibility, anticipated costs and benefits

23. This Consolidated Resolution has been developed by drawing on the experience of many stakeholders, including regulatory authorities, vehicle manufacturers and technical consultants. This Consolidated Resolution has been designed to update and improve upon existing standards. The requirements are based on existing concepts in present standards in different Contracting Parties.

24. Since this Consolidated Resolution is based on existing standards, Contracting Parties can adopt the procedure described here with expected reduced impacts on existing procedures, testing burden and test equipment.

25. This Consolidated Resolution does not hold regulatory status within Contracting Parties. Contracting Parties and manufactures may refer to this procedure when assessing particle emissions with the technical prescriptions of their own standards or regulations.

26. The principal economic benefit of this procedure, when adopted, will be the reduction of particle emissions from new combustion engines as well as the simplification of the test procedure for HD engine emission certification.

27. It is not possible to assess, at this moment, the total costs linked to this Consolidated Resolution. However, since the modifications introduced have a reduced impact on existing testing procedures and equipment, a limited impact on cost is expected as well.

28. Safety benefits are anticipated, but it is not yet possible to assess them in terms of the overall effect on human health.

Note: In this resolution the term SPN is used instead of PM number.

F. Applying this Consolidated Resolution

29. For ease of reference and reading, this Consolidated Resolution contains only the sections that have been modified to introduce the new options. These sections, Annex 4 and Appendix 8 to Annex 4 to the 07 series of amendments to UN Regulation No. 49, keep the same numbering of the relevant sections of 07 series of amendments to UN Regulation No. 49, as amended. In case of application of this Consolidated Resolution, the following sections can simply replace the corresponding sections in UN Regulation No. 49.

30. Contracting parties willing to adopt this methodology to measure SPN10 would substitute the content of the part II of this Consolidated Resolution into the relevant sections of the 07 series of amendments to UN Regulation No. 49, as amended.

II. Modifications to 07 series of amendments to UN Regulation No. 49, as amended

Annex 4

Test procedure

1. Introduction

This Annex is based on the world-wide harmonized heavy duty certification (WHDC), global technical regulation (GTR) No. 4.
2. Reserved[‡]
3. Definitions, symbols and abbreviations
 - 3.1. Definitions

For the purpose of this Regulation,

 - 3.1.1. "*Declared maximum power (P_{max})*" means the maximum power in ECE kW (net power) as declared by the manufacturer in his application for approval.
 - 3.1.2. "*Delay time*" means the difference in time between the change of the component to be measured at the reference point and a system response of 10 per cent of the final reading (t_{10}) with the sampling probe being defined as the reference point. For the gaseous components, this is the transport time of the measured component from the sampling probe to the detector.
 - 3.1.3. "*Drift*" means the difference between the zero or span responses of the measurement instrument after and before an emissions test.
 - 3.1.4. "*Full flow dilution method*" means the process of mixing the total exhaust flow with diluent prior to separating a fraction of the diluted exhaust stream for analysis.
 - 3.1.5. "*High speed (n_m)*" means the highest engine speed where 70 per cent of the declared maximum power occurs.
 - 3.1.6. "*Low speed (n_{lo})*" means the lowest engine speed where 55 per cent of the declared maximum power occurs.
 - 3.1.7. "*Maximum power (P_{max})*" means the maximum power in kW as specified by the manufacturer.
 - 3.1.8. "*Maximum torque speed*" means the engine speed at which the maximum torque is obtained from the engine, as specified by the manufacturer.
 - 3.1.9. "*Normalized torque*" means engine torque in per cent normalized to the maximum available torque at an engine speed.
 - 3.1.10. "*Operator demand*" means an engine operator's input to control engine output. The operator may be a person (i.e., manual), or a governor (i.e., automatic) that mechanically or electronically signals an input that demands engine output. Input may be from an accelerator pedal or signal, a throttle-control lever or signal, a fuel lever or signal, a speed lever or signal, or a governor setpoint or signal.
 - 3.1.11. "*Partial flow dilution method*" means the process of separating a part from the total exhaust flow, then mixing it with an appropriate amount of diluent prior to the particulate sampling filter.

[‡] The numbering of this annex is consistent with the numbering of gtr No. 4 on WHDC. However, some sections of the WHDC gtr are not needed in this annex.

- 3.1.12. "*Ramped steady state test cycle*" means a test cycle with a sequence of steady state engine test modes with defined speed and torque criteria at each mode and defined ramps between these modes (WHSC).
- 3.1.13. "*Rated speed*" means the maximum full load speed allowed by the governor as specified by the manufacturer in his sales and service literature, or, if such a governor is not present, the speed at which the maximum power is obtained from the engine, as specified by the manufacturer in his sales and service literature.
- 3.1.14. "*Response time*" means the difference in time between the change of the component to be measured at the reference point and a system response of 90 per cent of the final reading (t_{90}) with the sampling probe being defined as the reference point, whereby the change of the measured component is at least 60 per cent full scale (FS) and takes place in less than 0.1 second. The system response time consists of the delay time to the system and of the rise time of the system.
- 3.1.15. "*Rise time*" means the difference in time between the 10 per cent and 90 per cent response of the final reading ($t_{90} - t_{10}$).
- 3.1.16. "*Span response*" means the mean response to a span gas during a 30 s time interval.
- 3.1.17. "*Specific emissions*" means the mass emissions expressed in g/kWh.
- 3.1.18. "*Test cycle*" means a sequence of test points each with a defined speed and torque to be followed by the engine under steady state (WHSC) or transient operating conditions (WHTC).
- 3.1.19. "*Transformation time*" means the difference in time between the change of the component to be measured at the reference point and a system response of 50 per cent of the final reading (t_{50}) with the sampling probe being defined as the reference point. The transformation time is used for the signal alignment of different measurement instruments.
- 3.1.20. "*Transient test cycle*" means a test cycle with a sequence of normalized speed and torque values that vary relatively quickly with time (WHTC).
- 3.1.21. "*Zero response*" means the mean response to a zero gas during a 30 s time interval.

Figure 1
Definitions of system response

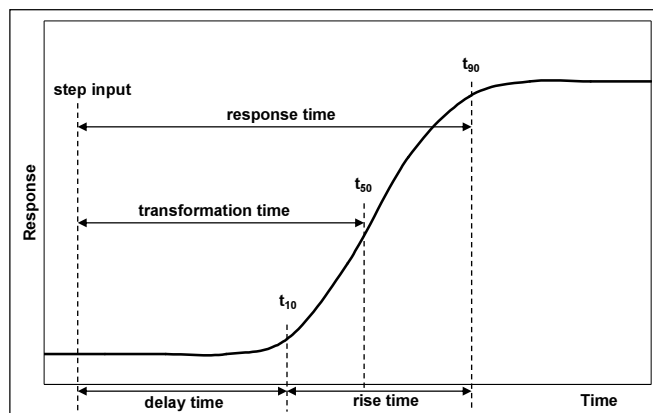

- 3.2. General symbols

<i>Symbol</i>	<i>Unit</i>	<i>Term</i>
a_1	-	Slope of the regression
a_0	-	y intercept of the regression
A/F_{st}	-	Stoichiometric air to fuel ratio
c	ppm/Vol per cent	Concentration
c_d	ppm/Vol per cent	Concentration on dry basis
c_w	ppm/Vol per cent	Concentration on wet basis
c_b	ppm/Vol per cent	Background concentration
C_d	-	Discharge coefficient of SSV
c_{gas}	ppm/Vol per cent	Concentration on the gaseous components
\bar{c}_s	particles per cubic centimetre	Average concentration of particles from the diluted exhaust gas corrected to standard conditions (273.2 K and 101.33 kPa) particles per cubic centimetre
$c_{s,i}$	particles per cubic centimetre	A discrete measurement of particle concentration in the diluted gas exhaust from the particle counter, corrected to standard conditions (273.2 K and 101.33 kPa)
d	m	Diameter
d_i		Particle electrical mobility diameter (30, 50 or 100 nm)
d_v	m	Throat diameter of venturi
D_0	m ³ /s	PDP calibration intercept
D	-	Dilution factor
Δt	s	Time interval
e		The number of particles emitted per kWh
e_{gas}	g/kWh	Specific emission of gaseous components
e_{PM}	g/kWh	Specific emission of particulates
e_r	g/kWh	Specific emission during regeneration
e_w	g/kWh	Weighted specific emission
E_{CO_2}	per cent	CO ₂ quench of NO _x analyzer
E_E	per cent	Ethane efficiency
E_{H_2O}	per cent	Water quench of NO _x analyzer
E_M	per cent	Methane efficiency
E_{NO_x}	per cent	Efficiency of NO _x converter
f	Hz	Data sampling rate
f_a	-	Laboratory atmospheric factor
F_s	-	Stoichiometric factor
\bar{f}_r	-	Mean particle concentration reduction factor of the volatile particle remover specific to the dilution settings used for the test
H_a	g/kg	Absolute humidity of the intake air
H_d	g/kg	Absolute humidity of the diluent

<i>Symbol</i>	<i>Unit</i>	<i>Term</i>
i	-	Subscript denoting an instantaneous measurement (e.g. 1 Hz)
k	-	Calibration factor to correct the particle number counter measurements to the level of the reference instrument where this is not applied internally within the particle number counter. Where the calibration factor is applied internally within the particle number counter, a value of 1 shall be used for k in the above equation
k_c	-	Carbon specific factor
$k_{f,d}$	m ³ /kg fuel	Combustion additional volume of dry exhaust
$k_{f,w}$	m ³ /kg fuel	Combustion additional volume of wet exhaust
$k_{h,D}$	-	Humidity correction factor for NO _x for CI engines
$k_{h,G}$	-	Humidity correction factor for NO _x for PI engines
k_r	-	The regeneration adjustment, according to paragraph 6.6.2., or in the case of engines without periodically regenerating after-treatment $k_r = 1$
$k_{r,d}$	-	Downward regeneration adjustment factor
$k_{r,u}$	-	Upward regeneration adjustment factor
$k_{w,a}$	-	Dry to wet correction factor for the intake air
$k_{w,d}$	-	Dry to wet correction factor for the diluent
$k_{w,e}$	-	Dry to wet correction factor for the diluted exhaust gas
$k_{w,r}$	-	Dry to wet correction factor for the raw exhaust gas
K_V	-	CFV calibration function
λ	-	Excess air ratio
m_b	mg	Particulate sample mass of the diluent collected
m_d	kg	Mass of the diluent sample passed through the particulate sampling filters
m_{ed}	kg	Total diluted exhaust mass over the cycle
m_{edf}	kg	Mass of equivalent diluted exhaust gas over the test cycle
m_{ew}	kg	Total exhaust mass over the cycle
m_{ex}	kg	Total mass of diluted exhaust gas extracted from the dilution tunnel for particle number sampling
m_f	mg	Particulate sampling filter mass
m_{gas}	g	Mass of gaseous emissions over the test cycle
m_p	mg	Particulate sample mass collected

<i>Symbol</i>	<i>Unit</i>	<i>Term</i>
m_{PM}	g	Mass of particulate emissions over the test cycle
$m_{PM,corr}$	g/test	Mass of particulates corrected for extraction of particle number sample flow
m_{se}	kg	Exhaust sample mass over the test cycle
m_{sed}	kg	Mass of diluted exhaust gas passing the dilution tunnel
m_{sep}	kg	Mass of diluted exhaust gas passing the particulate collection filters
m_{ssd}	kg	Mass of secondary diluent
M	Nm	Torque
M_a	g/mol	Molar mass of the intake air
M_d	g/mol	Molar mass of the diluent
M_e	g/mol	Molar mass of the exhaust
M_f	Nm	Torque absorbed by auxiliaries/equipment to be fitted
M_{gas}	g/mol	Molar mass of gaseous components
M_r	Nm	Torque absorbed by auxiliaries/equipment to be removed
N	-	Number of particles emitted over the test cycle
n	-	Number of measurements
n_r	-	Number of measurements with regeneration
n	min ⁻¹	Engine rotational speed
n_{hi}	min ⁻¹	High engine speed
n_{lo}	min ⁻¹	Low engine speed
n_{pref}	min ⁻¹	Preferred engine speed
n_p	r/s	PDP pump speed
N_{cold}	-	The total number of particles emitted over the WHTC cold test cycle
N_{hot}	-	The total number of particles emitted over the WHTC hot test cycle
N_{in}		Upstream particle number concentration
N_{out}		Downstream particle number concentration
p_a	kPa	Saturation vapour pressure of engine intake air
p_b	kPa	Total atmospheric pressure
p_d	kPa	Saturation vapour pressure of the diluent
p_p	kPa	Absolute pressure
p_r	kPa	Water vapour pressure after cooling bath
p_s	kPa	Dry atmospheric pressure
P	kW	Power
P_f	kW	Power absorbed by auxiliaries/equipment to be fitted

<i>Symbol</i>	<i>Unit</i>	<i>Term</i>
P_r	kW	Power absorbed by auxiliaries/equipment to be removed
q_{ex}	kg/s	Particle number sample mass flow rate
q_{mad}	kg/s	Intake air mass flow rate on dry basis
q_{maw}	kg/s	Intake air mass flow rate on wet basis
q_{mCe}	kg/s	Carbon mass flow rate in the raw exhaust gas
q_{mCf}	kg/s	Carbon mass flow rate into the engine
q_{mCp}	kg/s	Carbon mass flow rate in the partial flow dilution system
q_{mdew}	kg/s	Diluted exhaust gas mass flow rate on wet basis
q_{mdw}	kg/s	Diluent mass flow rate on wet basis
q_{medf}	kg/s	Equivalent diluted exhaust gas mass flow rate on wet basis
q_{mew}	kg/s	Exhaust gas mass flow rate on wet basis
q_{mex}	kg/s	Sample mass flow rate extracted from dilution tunnel
q_{mf}	kg/s	Fuel mass flow rate
q_{mp}	kg/s	Sample flow of exhaust gas into partial flow dilution system
q_{sw}	kg/s	Mass flow rate fed back into dilution tunnel to compensate for particle number sample extraction
q_{vCVS}	m ³ /s	CVS volume rate
q_{vs}	dm ³ /min	System flow rate of exhaust analyzer system
q_{vt}	cm ³ /min	Tracer gas flow rate
r^2	-	Coefficient of determination
r_d	-	Dilution ratio
r_D	-	Diameter ratio of SSV
r_h	-	Hydrocarbon response factor of the FID
r_m	-	Methanol response factor of the FID
r_p	-	Pressure ratio of SSV
r_s	-	Average sample ratio
s		Standard deviation
ρ	kg/m ³	Density
ρ_e	kg/m ³	Exhaust gas density
σ	-	Standard deviation
T	K	Absolute temperature
T_a	K	Absolute temperature of the intake air
t	s	Time
t_{10}	s	Time between step input and 10 per cent of final reading

<i>Symbol</i>	<i>Unit</i>	<i>Term</i>
t_{50}	s	Time between step input and 50 per cent of final reading
t_{90}	s	Time between step input and 90 per cent of final reading
u	-	Ratio between the densities (or molar masses) of the gas components and the exhaust gas divided by 1,000
V_0	m ³ /r	PDP gas volume pumped per revolution
V_s	dm ³	System volume of exhaust analyzer bench
W_{act}	kWh	Actual cycle work of the test cycle
$W_{act,cold}$	kWh	The actual cycle work over the WHTC cold test cycle according to paragraph 7.8.6.
$W_{act,hot}$	kWh	The actual cycle work over the WHTC hot test cycle according to paragraph 7.8.6.
W_{ref}	kWh	Reference cycle work of the test cycle
X_0	m ³ /r	PDP calibration function

3.3. Symbols and abbreviations for the fuel composition

w_{ALF}	Hydrogen content of fuel, per cent mass
w_{BET}	Carbon content of fuel, per cent mass
w_{GAM}	Sulphur content of fuel, per cent mass
w_{DEL}	Nitrogen content of fuel, per cent mass
w_{EPS}	Oxygen content of fuel, per cent mass
α	Molar hydrogen ratio (H/C)
γ	Molar sulphur ratio (S/C)
δ	Molar nitrogen ratio (N/C)
ε	Molar oxygen ratio (O/C)

referring to a fuel $CH_\alpha O_\varepsilon N_\delta S_\gamma$

3.4. Symbols and abbreviations for the chemical components

C1	Carbon 1 equivalent hydrocarbon
CH ₄	Methane
C ₂ H ₆	Ethane
C ₃ H ₈	Propane
CO	Carbon monoxide
CO ₂	Carbon dioxide
DOP	Di-octylphthalate
HC	Hydrocarbons
H ₂ O	Water
NMHC	Non-methane hydrocarbons

NO _x	Oxides of nitrogen
NO	Nitric oxide
NO ₂	Nitrogen dioxide
PM	Particulate matter
SPN	Solid Particle Number

3.5. Abbreviations

CFV	Critical flow venturi
CLD	Chemiluminescent detector
CVS	Constant volume sampling
deNO _x	NO _x after-treatment system
EGR	Exhaust gas recirculation
ET	Evaporation tube
FID	Flame ionization detector
FTIR	Fourier transform infrared analyser
GC	Gas chromatograph
HCLD	Heated chemiluminescent detector
HFID	Heated flame ionization detector
LDS	Laser diode spectrometer
LPG	Liquefied petroleum gas
NDIR	Non-dispersive infrared (analyzer)
NG	Natural gas
NMC	Non-methane cutter
OT	Outlet tube
PDP	Positive displacement pump
Per cent FS	Per cent of full scale
PCF	Particle pre-classifier
PFS	Partial flow system
PNC	Particle number counter
PND	Particle number diluter
PTS	Particle transfer system
PTT	Particle transfer tube
SSV	Subsonic venturi
VGT	Variable geometry turbine
VPR	Volatile particle remover
WHSC	World harmonized steady state cycle
WHTC	World harmonized transient cycle

4. General requirements

The engine system shall be so designed, constructed and assembled as to enable the engine in normal use to comply with the provisions of this annex during its useful life, as defined in this Regulation, including when installed in the vehicle.

5. Performance requirements

5.1. Emission of gaseous and particulate pollutants

The emissions of gaseous and particulate pollutants by the engine shall be determined on the WHTC and WHSC test cycles, as described in paragraph 7. The measurement systems shall meet the linearity requirements in paragraph 9.2. and the specifications in paragraph 9.3. (gaseous emissions measurement), paragraph 9.4. (particulate measurement) and in Appendix 2 to this annex.

Other systems or analyzers may be approved by the Type Approval Authority, if it is found that they yield equivalent results in accordance with paragraph 5.1.1.

5.1.1. Equivalency

The determination of system equivalency shall be based on a seven-sample pair (or larger) correlation study between the system under consideration and one of the systems of this annex.

"Results" refer to the specific cycle weighted emissions value. The correlation testing is to be performed at the same laboratory, test cell, and on the same engine, and is preferred to be run concurrently. The equivalency of the sample pair averages shall be determined by F-test and t-test statistics as described in Appendix 3, paragraph A.3.3., obtained under the laboratory test cell and the engine conditions described above. Outliers shall be determined in accordance with ISO 5725 and excluded from the database. The systems to be used for correlation testing shall be subject to the approval by the Type Approval Authority.

5.2. Engine family

5.2.1. General

An engine family is characterized by design parameters. These shall be common to all engines within the family. The engine manufacturer may decide which engines belong to an engine family, as long as the membership criteria listed in paragraph 5.2.3. are respected. The engine family shall be approved by the Type Approval Authority. The manufacturer shall provide to the Type Approval Authority the appropriate information relating to the emission levels of the members of the engine family.

5.2.2. Special cases

In some cases there may be interaction between parameters. This shall be taken into consideration to ensure that only engines with similar exhaust emission characteristics are included within the same engine family. These cases shall be identified by the manufacturer and notified to the Type Approval Authority. It shall then be taken into account as a criterion for creating a new engine family.

In case of devices or features, which are not listed in paragraph 5.2.3. and which have a strong influence on the level of emissions, this equipment shall be identified by the manufacturer on the basis of good engineering practice, and shall be notified to the Type Approval Authority. It shall then be taken into account as a criterion for creating a new engine family.

In addition to the parameters listed in paragraph 5.2.3., the manufacturer may introduce additional criteria allowing the definition of families of more restricted size. These parameters are not necessarily parameters that have an influence on the level of emissions.

- 5.2.3. Parameters defining the engine family
 - 5.2.3.1. Combustion cycle
 - (a) 2-stroke cycle;
 - (b) 4-stroke cycle;
 - (c) Rotary engine;
 - (d) Others.
 - 5.2.3.2. Configuration of the cylinders
 - 5.2.3.2.1. Position of the cylinders in the block
 - (a) V;
 - (b) In line;
 - (c) Radial;
 - (d) Others (F, W, etc.).
 - 5.2.3.2.2. Relative position of the cylinders

Engines with the same block may belong to the same family as long as their bore center-to-center dimensions are the same.
 - 5.2.3.3. Main cooling medium
 - (a) Air;
 - (b) Water;
 - (c) Oil.
 - 5.2.3.4. Individual cylinder displacement
 - 5.2.3.4.1. Engine with a unit cylinder displacement $\geq 0.75 \text{ dm}^3$

In order for engines with a unit cylinder displacement of $\geq 0.7 \text{ dm}^3$ to be considered to belong to the same engine family, the spread of their individual cylinder displacements shall not exceed 15 per cent of the largest individual cylinder displacement within the family.
 - 5.2.3.4.2. Engine with a unit cylinder displacement $< 0.75 \text{ dm}^3$

In order for engines with a unit cylinder displacement of $< 0.75 \text{ dm}^3$ to be considered to belong to the same engine family, the spread of their individual cylinder displacements shall not exceed 30 per cent of the largest individual cylinder displacement within the family.
 - 5.2.3.4.3. Engine with other unit cylinder displacement limits

Engines with an individual cylinder displacement that exceeds the limits defined in paragraphs 5.2.3.4.1. and 5.2.3.4.2. may be considered to belong to the same family with the approval of the Type Approval Authority. The approval shall be based on technical elements (calculations, simulations, experimental results etc.) showing that exceeding the limits does not have a significant influence on the exhaust emissions.
 - 5.2.3.5. Method of air aspiration
 - (a) Naturally aspirated;
 - (b) Pressure charged;
 - (c) Pressure charged with charge cooler.
 - 5.2.3.6. Fuel type
 - (a) Diesel;
 - (b) Natural gas (NG);

- (c) Liquefied petroleum gas (LPG);
 - (d) Ethanol.
- 5.2.3.7. Combustion chamber type
- (a) Open chamber;
 - (b) Divided chamber;
 - (c) Other types.
- 5.2.3.8. Ignition Type
- (a) Positive ignition;
 - (b) Compression ignition.
- 5.2.3.9. Valves and porting
- (a) Configuration;
 - (b) Number of valves per cylinder.
- 5.2.3.10. Fuel supply type
- (a) Liquid fuel supply type:
 - (i) Pump and (high pressure) line and injector;
 - (ii) In-line or distributor pump;
 - (iii) Unit pump or unit injector;
 - (iv) Common rail;
 - (v) Carburettor(s);
 - (vi) Others.
 - (b) Gas fuel supply type:
 - (i) Gaseous;
 - (ii) Liquid;
 - (iii) Mixing units;
 - (iv) Others.
 - (c) Other types.
- 5.2.3.11. Miscellaneous devices
- (a) Exhaust gas recirculation (EGR);
 - (b) Water injection;
 - (c) Air injection;
 - (d) Others.
- 5.2.3.12. Electronic control strategy
- The presence or absence of an electronic control unit (ECU) on the engine is regarded as a basic parameter of the family.
- In the case of electronically controlled engines, the manufacturer shall present the technical elements explaining the grouping of these engines in the same family, i.e. the reasons why these engines can be expected to satisfy the same emission requirements.
- These elements can be calculations, simulations, estimations, description of injection parameters, experimental results, etc.

Examples of controlled features are:

- (a) Timing;
- (b) Injection pressure;
- (c) Multiple injections;
- (d) Boost pressure;
- (e) VGT;
- (f) EGR.

5.2.3.13. Exhaust after-treatment systems

The function and combination of the following devices are regarded as membership criteria for an engine family:

- (a) Oxidation catalyst;
- (b) Three-way catalyst;
- (c) deNO_x system with selective reduction of NO_x (addition of reducing agent);
- (d) Other deNO_x systems;
- (e) Particulate trap with passive regeneration;
- (f) Particulate trap with active regeneration;
- (g) Other particulate traps;
- (h) Other devices.

When an engine has been certified without an after-treatment system, whether as parent engine or as member of the family, then this engine, when equipped with an oxidation catalyst, may be included in the same engine family, if it does not require different fuel characteristics.

If it requires specific fuel characteristics (e.g. particulate traps requiring special additives in the fuel to ensure the regeneration process), the decision to include it in the same family shall be based on technical elements provided by the manufacturer. These elements shall indicate that the expected emission level of the equipped engine complies with the same limit value as the non-equipped engine.

When an engine has been certified with an after-treatment system, whether as parent engine or as member of a family, whose parent engine is equipped with the same after-treatment system, then this engine, when equipped without after-treatment system, shall not be added to the same engine family.

5.2.4. Choice of the parent engine

5.2.4.1. Compression ignition engines

Once the engine family has been agreed by the Type Approval Authority, the parent engine of the family shall be selected using the primary criterion of the highest fuel delivery per stroke at the declared maximum torque speed. In the event that two or more engines share this primary criterion, the parent engine shall be selected using the secondary criterion of highest fuel delivery per stroke at rated speed.

5.2.4.2. Positive ignition engines

Once the engine family has been agreed by the Type Approval Authority, the parent engine of the family shall be selected using the primary criterion of the largest displacement. In the event that two or more engines share this primary criterion, the parent engine shall be selected using the secondary criterion in the following order of priority:

- (a) The highest fuel delivery per stroke at the speed of declared rated power;
- (b) The most advanced spark timing;
- (c) The lowest EGR rate.

5.2.4.3. Remarks on the choice of the parent engine

The Type Approval Authority may conclude that the worst-case emission of the family can best be characterized by testing additional engines. In this case, the engine manufacturer shall submit the appropriate information to determine the engines within the family likely to have the highest emissions level.

If engines within the family incorporate other features which may be considered to affect exhaust emissions, these features shall also be identified and taken into account in the selection of the parent engine.

If engines within the family meet the same emission values over different useful life periods, this shall be taken into account in the selection of the parent engine.

6. Test conditions

6.1. Laboratory test conditions

The absolute temperature (T_a) of the engine intake air expressed in Kelvin, and the dry atmospheric pressure (p_s), expressed in kPa shall be measured and the parameter f_a shall be determined according to the following provisions. In multi-cylinder engines having distinct groups of intake manifolds, such as in a "Vee" engine configuration, the average temperature of the distinct groups shall be taken. The parameter f_a shall be reported with the test results. For better repeatability and reproducibility of the test results, it is recommended that the parameter f_a be such that: $0.93 \leq f_a \leq 1.07$.

(a) Compression-ignition engines:

Naturally aspirated and mechanically supercharged engines:

$$f_a = \left(\frac{99}{p_s} \right) \times \left(\frac{T_a}{298} \right)^{0.7} \quad (1)$$

Turbocharged engines with or without cooling of the intake air:

$$f_a = \left(\frac{99}{p_s} \right)^{0.7} \times \left(\frac{T_a}{298} \right)^{1.5} \quad (2)$$

(b) Positive ignition engines:

$$f_a = \left(\frac{99}{p_s} \right)^{1.2} \times \left(\frac{T_a}{298} \right)^{0.6} \quad (3)$$

6.2. Engines with charge air-cooling

The charge air temperature shall be recorded and shall be, at the rated speed and full load, within ± 5 K of the maximum charge air temperature specified by the manufacturer. The temperature of the cooling medium shall be at least 293 K (20 °C).

If a test laboratory system or external blower is used, the coolant flow rate shall be set to achieve a charge air temperature within ± 5 K of the maximum charge air temperature specified by the manufacturer at the rated speed and full load. Coolant temperature and coolant flow rate of the charge air cooler at the above set point shall not be changed for the whole test cycle, unless this results in unrepresentative overcooling of the charge air. The charge air cooler volume

shall be based upon good engineering practice and shall be representative of the production engine's in-use installation. The laboratory system shall be designed to minimize accumulation of condensate. Any accumulated condensate shall be drained and all drains shall be completely closed before emission testing.

If the engine manufacturer specifies pressure-drop limits across the charge-air cooling system, it shall be ensured that the pressure drop across the charge-air cooling system at engine conditions specified by the manufacturer is within the manufacturer's specified limit(s). The pressure drop shall be measured at the manufacturer's specified locations.

6.3. Engine power

The basis of specific emissions measurement is engine power and cycle work as determined in accordance with paragraphs 6.3.1. to 6.3.5.

6.3.1. General engine installation

The engine shall be tested with the auxiliaries/equipment listed in Appendix 6.

If auxiliaries/equipment are not installed as required, their power shall be taken into account in accordance with paragraphs 6.3.2. to 6.3.5.

6.3.2. Auxiliaries/equipment to be fitted for the emissions test

If it is inappropriate to install the auxiliaries/equipment required according to Appendix 6 to this annex on the test bench, the power absorbed by them shall be determined and subtracted from the measured engine power (reference and actual) over the whole engine speed range of the WHTC and over the test speeds of the WHSC.

6.3.3. Auxiliaries/equipment to be removed for the test

Where the auxiliaries/equipment not required according to Appendix 6 to this annex cannot be removed, the power absorbed by them may be determined and added to the measured engine power (reference and actual) over the whole engine speed range of the WHTC and over the test speeds of the WHSC. If this value is greater than 3 per cent of the maximum power at the test speed it shall be demonstrated to the Type Approval Authority.

6.3.4. Determination of auxiliary power

The power absorbed by the auxiliaries/equipment needs only be determined, if:

(a) Auxiliaries/equipment required according to Appendix 6 to this annex, are not fitted to the engine;

and/or

(b) Auxiliaries/equipment not required according to Appendix 6 to this annex, are fitted to the engine.

The values of auxiliary power and the measurement/calculation method for determining auxiliary power shall be submitted by the engine manufacturer for the whole operating area of the test cycles, and approved by the Type Approval Authority.

6.3.5. Engine cycle work

The calculation of reference and actual cycle work (see paragraphs 7.4.8. and 7.8.6.) shall be based upon engine power according to paragraph 6.3.1. In this case, P_f and P_r of equation 4 are zero, and P equals P_m .

If auxiliaries/equipment are installed according to paragraphs 6.3.2. and/or 6.3.3., the power absorbed by them shall be used to correct each instantaneous cycle power value $P_{m,i}$, as follows:

$$P_i = P_{m,i} - P_{f,i} + P_{r,i} \quad (4)$$

Where:

$P_{m,i}$ is the measured engine power, kW

$P_{f,i}$ is the power absorbed by auxiliaries/equipment to be fitted, kW

$P_{r,i}$ is the power absorbed by auxiliaries/equipment to be removed, kW.

6.4. Engine air intake system

An engine air intake system or a test laboratory system shall be used presenting an air intake restriction within ± 300 Pa of the maximum value specified by the manufacturer for a clean air cleaner at the rated speed and full load. The static differential pressure of the restriction shall be measured at the location specified by the manufacturer.

6.5. Engine exhaust system

An engine exhaust system or a test laboratory system shall be used presenting an exhaust backpressure within 80 to 100 per cent of the maximum value specified by the manufacturer at the rated speed and full load. If the maximum restriction is 5 kPa or less, the set point shall be no less than 1.0 kPa from the maximum. The exhaust system shall conform to the requirements for exhaust gas sampling, as set out in paragraphs 9.3.10. and 9.3.11.

6.6. Engine with exhaust after-treatment system

If the engine is equipped with an exhaust after-treatment system, the exhaust pipe shall have the same diameter as found in-use, or as specified by the manufacturer, for at least four pipe diameters upstream of the expansion section containing the after-treatment device. The distance from the exhaust manifold flange or turbocharger outlet to the exhaust after-treatment system shall be the same as in the vehicle configuration or within the distance specifications of the manufacturer. The exhaust backpressure or restriction shall follow the same criteria as above, and may be set with a valve. For variable-restriction after-treatment devices, the maximum exhaust restriction is defined at the after-treatment condition (degreening/ageing and regeneration/loading level) specified by the manufacturer. If the maximum restriction is 5 kPa or less, the set point shall be no less than 1.0 kPa from the maximum. The after-treatment container may be removed during dummy tests and during engine mapping, and replaced with an equivalent container having an inactive catalyst support.

The emissions measured on the test cycle shall be representative of the emissions in the field. In the case of an engine equipped with an exhaust after-treatment system that requires the consumption of a reagent, the reagent used for all tests shall be declared by the manufacturer.

Engines equipped with exhaust after-treatment systems with continuous regeneration do not require a special test procedure, but the regeneration process needs to be demonstrated according to paragraph 6.6.1.

For engines equipped with exhaust after-treatment systems that are regenerated on a periodic basis, as described in paragraph 6.6.2., emission results shall be adjusted to account for regeneration events. In this case, the average emission depends on the frequency of the regeneration event in terms of fraction of tests during which the regeneration occurs.

6.6.1. Continuous regeneration

The emissions shall be measured on an after-treatment system that has been stabilized so as to result in repeatable emissions behaviour. The regeneration process shall occur at least once during the WHTC hot start test and the

manufacturer shall declare the normal conditions under which regeneration occurs (soot load, temperature, exhaust back-pressure, etc.).

In order to demonstrate that the regeneration process is continuous, at least three WHTC hot start tests shall be conducted. For the purpose of this demonstration, the engine shall be warmed up in accordance with paragraph 7.4.1., the engine be soaked according to paragraph 7.6.3. and the first WHTC hot start test be run. The subsequent hot start tests shall be started after soaking according to paragraph 7.6.3. During the tests, exhaust temperatures and pressures shall be recorded (temperature before and after the after-treatment system, exhaust back pressure, etc.).

If the conditions declared by the manufacturer occur during the tests and the results of the three (or more) WHTC hot start tests do not scatter by more than ± 25 per cent or 0.005 g/kWh, whichever is greater, the after-treatment system is considered to be of the continuous regeneration type, and the general test provisions of paragraph 7.6. (WHTC) and paragraph 7.7. (WHSC) apply.

If the exhaust after-treatment system has a security mode that shifts to a periodic regeneration mode, it shall be checked according to paragraph 6.6.2. For that specific case, the applicable emission limits may be exceeded and would not be weighted.

6.6.2. Periodic regeneration

For an exhaust after-treatment based on a periodic regeneration process, the emissions shall be measured on at least three WHTC hot start tests, one with and two without a regeneration event on a stabilized after-treatment system, and the results be weighted in accordance with equation 5.

The regeneration process shall occur at least once during the WHTC hot start test. The engine may be equipped with a switch capable of preventing or permitting the regeneration process provided this operation has no effect on the original engine calibration.

The manufacturer shall declare the normal parameter conditions under which the regeneration process occurs (soot load, temperature, exhaust back-pressure, etc.) and its duration. The manufacturer shall also provide the frequency of the regeneration event in terms of number of tests during which the regeneration occurs compared to number of tests without regeneration. The exact procedure to determine this frequency shall be based upon in-use data using good engineering judgement, and shall be agreed by the type approval or certification authority.

The manufacturer shall provide an after-treatment system that has been loaded in order to achieve regeneration during a WHTC test. For the purpose of this testing, the engine shall be warmed up in accordance with paragraph 7.4.1., the engine be soaked according to paragraph 7.6.3. and the WHTC hot start test be started. Regeneration shall not occur during the engine warm-up.

Average specific emissions between regeneration phases shall be determined from the arithmetic mean of several approximately equidistant WHTC hot start test results (g/kWh). As a minimum, at least one WHTC hot start test as close as possible prior to a regeneration test and one WHTC hot start test immediately after a regeneration test shall be conducted. As an alternative, the manufacturer may provide data to show that the emissions remain constant (± 25 per cent or 0.005 g/kWh, whichever is greater) between regeneration phases. In this case, the emissions of only one WHTC hot start test may be used.

During the regeneration test, all the data needed to detect regeneration shall be recorded (CO or NO_x emissions, temperature before and after the after-treatment system, exhaust back pressure, etc.).

During the regeneration test, the applicable emission limits may be exceeded.

The test procedure is schematically shown in Figure 2.

Figure 2

Scheme of periodic regeneration

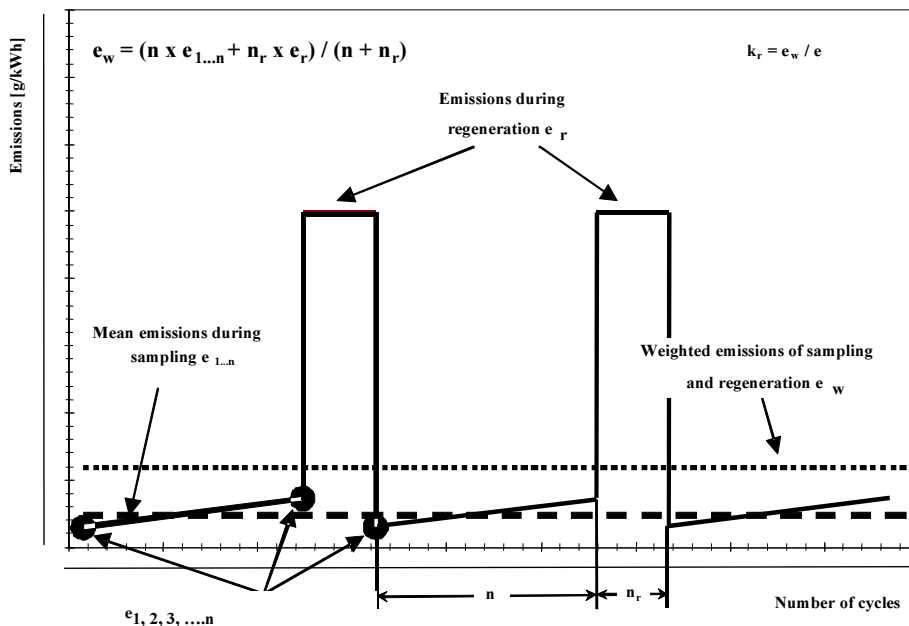

The WHTC hot start emissions shall be weighted as follows:

$$e_w = \frac{n \times \bar{e} + n_r \times \bar{e}_r}{n + n_r} \quad (5)$$

Where:

- n is the number of WHTC hot start tests without regeneration
- n_r is the number of WHTC hot start tests with regeneration (minimum one test)
- \bar{e} is the average specific emission without regeneration, g/kWh
- \bar{e}_r is the average specific emission with regeneration, g/kWh

For the determination of \bar{e}_r , the following provisions apply:

- (a) If regeneration takes more than one hot start WHTC, consecutive full hot start WHTC tests shall be conducted and emissions continued to be measured without soaking and without shutting the engine off, until regeneration is completed, and the average of the hot start WHTC tests be calculated;
- (b) If regeneration is completed during any hot start WHTC, the test shall be continued over its entire length.

In agreement with the Type Approval Authority, the regeneration adjustment factors may be applied either multiplicative (c) or additive (d) based upon good engineering analysis.

- (c) The multiplicative adjustment factors shall be calculated as follows:

$$k_{r,u} = \frac{e_w}{e} \quad (\text{upward}) \quad (6)$$

$$k_{r,d} = \frac{e_w}{e_r} \quad (\text{downward}) \quad (6a)$$

- (d) The additive adjustment factors shall be calculated as follows:

$$k_{r,u} = e_w - e \quad (\text{upward}) \quad (7)$$

$$k_{r,d} = e_w - e_r \quad (\text{downward}) \quad (8)$$

With reference to the specific emission calculations in paragraph 8.6.3., the regeneration adjustment factors shall be applied, as follows:

- (e) For a test without regeneration, $k_{r,u}$ shall be multiplied with or be added to, respectively, the specific emission e in equations 69 or 70;
- (f) For a test with regeneration, $k_{r,d}$ shall be multiplied with or be added to, respectively, the specific emission e in equations 69 or 70.

At the request of the manufacturer, the regeneration adjustment factors:

- (g) May be extended to other members of the same engine family;
- (h) May be extended to other engine families using the same after-treatment system with the prior approval of the type approval or certification authority based on technical evidence to be supplied by the manufacturer, that the emissions are similar.

6.7. Cooling system

An engine cooling system with sufficient capacity to maintain the engine at normal operating temperatures prescribed by the manufacturer shall be used.

6.8. Lubricating oil

The lubricating oil shall be specified by the manufacturer and be representative of lubricating oil available on the market; the specifications of the lubricating oil used for the test shall be recorded and presented with the results of the test.

6.9. Specification of the reference fuel

The reference fuels are specified in Annex 5.

The fuel temperature shall be in accordance with the manufacturer's recommendations.

6.10. Crankcase emissions

No crankcase emissions shall be discharged directly into the ambient atmosphere, with the following exception: engines equipped with turbochargers, pumps, blowers, or superchargers for air induction may discharge crankcase emissions to the ambient atmosphere if the emissions are added to the exhaust emissions (either physically or mathematically) during all emission testing. Manufacturers taking advantage of this exception shall install the engines so that all crankcase emission can be routed into the emissions sampling system.

For the purpose of this paragraph, crankcase emissions that are routed into the exhaust upstream of exhaust after-treatment during all operation are not considered to be discharged directly into the ambient atmosphere.

Open crankcase emissions shall be routed into the exhaust system for emission measurement, as follows:

- (a) The tubing materials shall be smooth-walled, electrically conductive, and not reactive with crankcase emissions. Tube lengths shall be minimized as far as possible;
 - (b) The number of bends in the laboratory crankcase tubing shall be minimized, and the radius of any unavoidable bend shall be maximized;
 - (c) The laboratory crankcase exhaust tubing shall be heated, thin-walled or insulated and shall meet the engine manufacturer's specifications for crankcase back pressure;
 - (d) The crankcase exhaust tubing shall connect into the raw exhaust downstream of any after-treatment system, downstream of any installed exhaust restriction, and sufficiently upstream of any sample probes to ensure complete mixing with the engine's exhaust before sampling. The crankcase exhaust tube shall extend into the free stream of exhaust to avoid boundary-layer effects and to promote mixing. The crankcase exhaust tube's outlet may orient in any direction relative to the raw exhaust flow.
- 6.11. Paragraphs 6.11.1. and 6.11.2. shall apply to positive-ignition engines fuelled with petrol or E85.
- 6.11.1. The pressure in the crankcase shall be measured over the emissions test cycles at an appropriate location. The pressure in the intake manifold shall be measured to within ± 1 kPa.
- 6.11.2. Compliance with paragraph 6.10. shall be deemed satisfactory if, in every condition of measurement set out in paragraph 6.11.1., the pressure measured in the crankcase does not exceed the atmospheric pressure prevailing at the time of measurement.
7. Test procedures
- 7.1. Principles of emissions measurement
- To measure the specific emissions, the engine shall be operated over the test cycles defined in paragraphs 7.2.1. and 7.2.2. The measurement of specific emissions requires the quantification of the mass or number of components of designated emissions species in the exhaust and the corresponding engine cycle work. The components are determined by the sampling methods described in paragraphs 7.1.1. and 7.1.2.
- 7.1.1. Continuous sampling
- In continuous sampling, the component's concentration is measured continuously from raw or dilute exhaust. This concentration is multiplied by the continuous (raw or dilute) exhaust flow rate at the emission sampling location to determine the component's mass or number flow rate. The component's emission is continuously summed over the test cycle. This sum is the total mass or number of the emitted component.
- 7.1.2. Batch sampling
- In batch sampling, a sample of raw or dilute exhaust is continuously extracted and stored for later measurement. The extracted sample shall be proportional to the raw or diluted exhaust flow rate. Examples of batch sampling are collecting diluted gaseous components in a bag and collecting particulate matter (PM) on a filter. The batch sampled concentrations are multiplied by the total exhaust mass or mass flow (raw or diluted) from which it was extracted during the test cycle. This product is the total mass (or number) or mass (or number) flow of the emitted component. To calculate the PM concentration, the PM deposited onto a filter from proportionally extracted exhaust shall be divided by the amount of filtered exhaust.
- 7.1.3. Measurement procedures

This annex applies two measurement procedures that are functionally equivalent. Both procedures may be used for both the WHTC and the WHSC test cycle:

- (a) The gaseous components are sampled continuously in the raw exhaust gas, and the particulates are determined using a partial flow dilution system;
- (b) The gaseous components and the particulates are determined using a full flow dilution system (CVS system).

Any combination of the two principles (e.g. raw gaseous measurement and full flow particulate measurement) is permitted.

Solid Particle Number (SPN) can be determined by a suitable measurement system employing fixed ratio dilution as the initial dilution stage, or with proportional flow dilution by a partial-flow dilution system or a full-flow dilution system as the initial dilution stage.

7.2. Test cycles

7.2.1. Transient test cycle WHTC

The transient test cycle WHTC is listed in Appendix 1 as a second-by-second sequence of normalized speed and torque values. In order to perform the test on an engine test cell, the normalized values shall be converted to the actual values for the individual engine under test based on the engine-mapping curve. The conversion is referred to as denormalization, and the test cycle so developed as the reference cycle of the engine to be tested. With those references speed and torque values, the cycle shall be run on the test cell, and the actual speed, torque and power values shall be recorded. In order to validate the test run, a regression analysis between reference and actual speed, torque and power values shall be conducted upon completion of the test.

For calculation of the brake specific emissions, the actual cycle work shall be calculated by integrating actual engine power over the cycle. For cycle validation, the actual cycle work shall be within prescribed limits of the reference cycle work.

For the gaseous pollutants, continuous sampling (raw or dilute exhaust gas) or batch sampling (dilute exhaust gas) may be used. The particulate sample shall be diluted with a conditioned diluent (such as ambient air), and collected on a single suitable filter. Solid Particle Number (SPN) can be determined by a suitable measurement system employing fixed ratio dilution as the initial dilution stage, or with proportional flow dilution by a partial-flow dilution system or a full-flow dilution system as the initial dilution stage. The WHTC is shown schematically in Figure 3.

Figure 3
WHTC test cycle

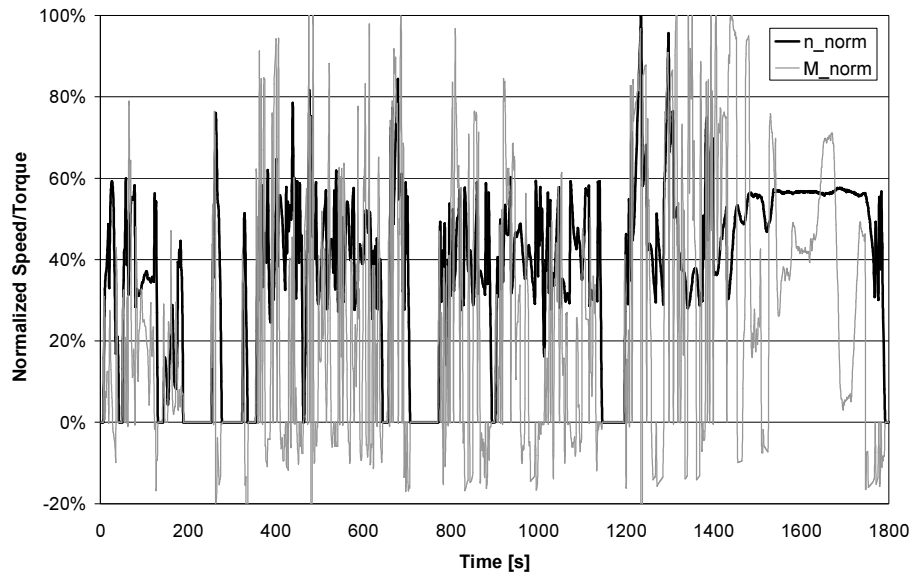

7.2.2. Ramped steady state test cycle WHSC

The ramped steady state test cycle WHSC consists of a number of normalized speed and load modes which shall be converted to the reference values for the individual engine under test based on the engine-mapping curve. The engine shall be operated for the prescribed time in each mode, whereby engine speed and load shall be changed linearly within 20 ± 1 seconds. In order to validate the test run, a regression analysis between reference and actual speed, torque and power values shall be conducted upon completion of the test.

The concentration of each gaseous pollutant, exhaust flow and power output shall be determined over the test cycle. The gaseous pollutants may be recorded continuously or sampled into a sampling bag. The particulate sample shall be diluted with a conditioned diluent (such as ambient air). One sample over the complete test procedure shall be taken, and collected on a single suitable filter. Solid Particle Number (SPN) can be determined by a suitable measurement system employing fixed ratio dilution as the initial dilution stage, or with proportional flow dilution by a partial-flow dilution system or a full-flow dilution system as the initial dilution stage.

For calculation of the brake specific emissions, the actual cycle work shall be calculated by integrating actual engine power over the cycle.

The WHSC is shown in Table 1. Except for mode 1, the start of each mode is defined as the beginning of the ramp from the previous mode.

Table 1
WHSC test cycle

<i>Mode</i>	<i>Normalized speed (per cent)</i>	<i>Normalized torque (per cent)</i>	<i>Mode length (s) incl. 20 s ramp</i>
1	0	0	210
2	55	100	50
3	55	25	250
4	55	70	75
5	35	100	50
6	25	25	200
7	45	70	75
8	45	25	150
9	55	50	125
10	75	100	50
11	35	50	200
12	35	25	250
13	0	0	210
Sum			1,895

7.3. General test sequence

The following flow chart outlines the general guidance that should be followed during testing. The details of each step are described in the relevant paragraphs. Deviations from the guidance are permitted where appropriate, but the specific requirements of the relevant paragraphs are mandatory.

For the WHTC, the test procedure consists of a cold start test following either natural or forced cool-down of the engine, a hot soak period and a hot start test.

For the WHSC, the test procedure consists of a hot start test following engine preconditioning at WHSC mode 9.

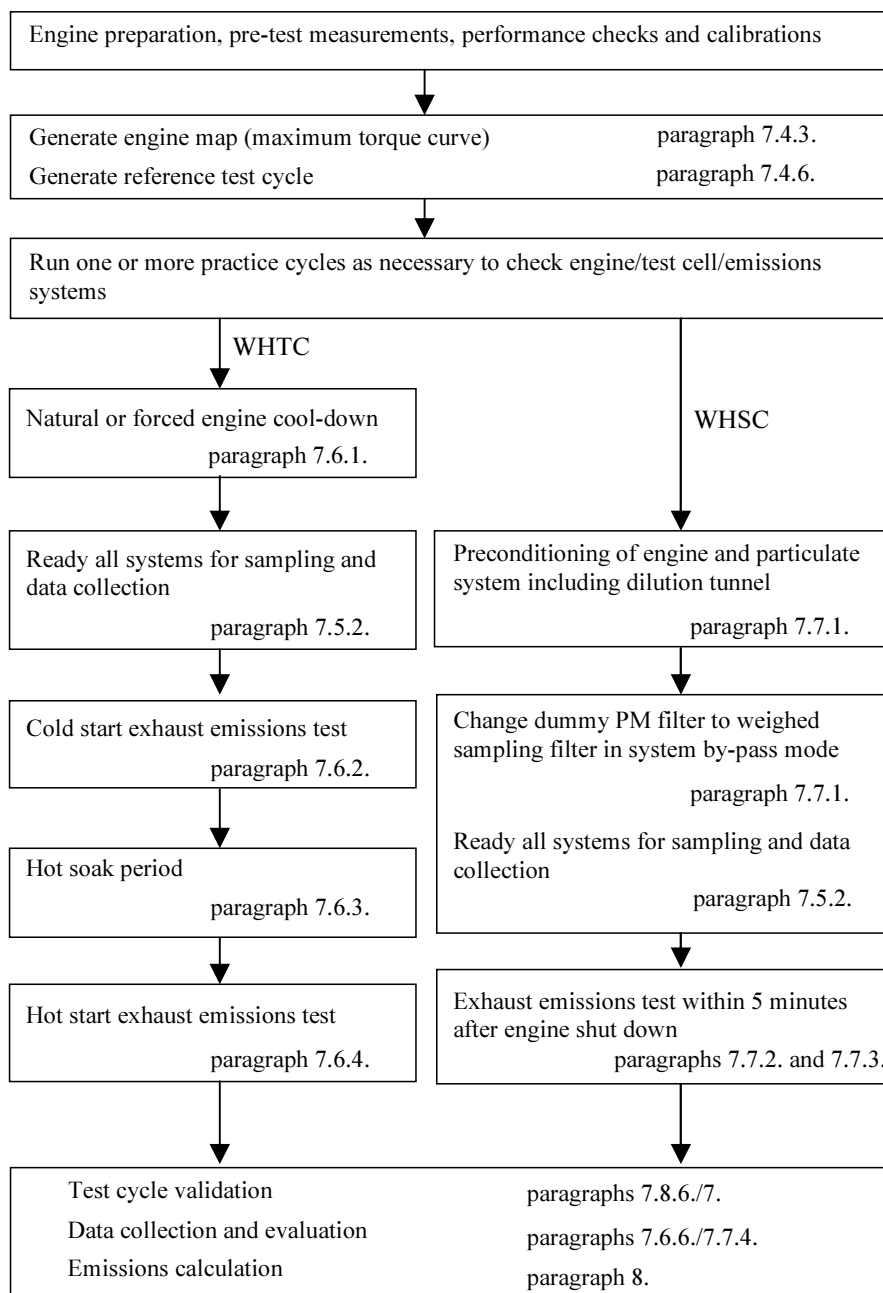

7.4. Engine mapping and reference cycle

Pre-test engine measurements, pre-test engine performance checks and pre-test system calibrations shall be made prior to the engine mapping procedure in line with the general test sequence shown in paragraph 7.3.

As basis for WHTC and WHSC reference cycle generation, the engine shall be mapped under full load operation for determining the speed vs. maximum torque and speed vs. maximum power curves. The mapping curve shall be used for denormalizing engine speed (paragraph 7.4.6.) and engine torque (paragraph 7.4.7.).

7.4.1. Engine warm-up

The engine shall be warmed up between 75 per cent and 100 per cent of its maximum power or according to the recommendation of the manufacturer and

good engineering judgment. Towards the end of the warm up it shall be operated in order to stabilize the engine coolant and lube oil temperatures to within ± 2 per cent of its mean values for at least 2 minutes or until the engine thermostat controls engine temperature.

7.4.2. Determination of the mapping speed range

The minimum and maximum mapping speeds are defined as follows:

Minimum mapping speed = idle speed

Maximum mapping speed = $n_{hi} \times 1.02$ or speed where full load torque drops off to zero, whichever is smaller.

7.4.3. Engine mapping curve

When the engine is stabilized according to paragraph 7.4.1., the engine mapping shall be performed according to the following procedure.

- (a) The engine shall be unloaded and operated at idle speed;
- (b) The engine shall be operated with maximum operator demand at minimum mapping speed;
- (c) The engine speed shall be increased at an average rate of $8 \pm 1 \text{ min}^{-1}/\text{s}$ from minimum to maximum mapping speed, or at a constant rate such that it takes 4 to 6 minutes to sweep from minimum to maximum mapping speed. Engine speed and torque points shall be recorded at a sample rate of at least one point per second.

When selecting option (b) in paragraph 7.4.7. for determining negative reference torque, the mapping curve may directly continue with minimum operator demand from maximum to minimum mapping speed.

7.4.4. Alternate mapping

If a manufacturer believes that the above mapping techniques are unsafe or unrepresentative for any given engine, alternate mapping techniques may be used. These alternate techniques shall satisfy the intent of the specified mapping procedures to determine the maximum available torque at all engine speeds achieved during the test cycles. Deviations from the mapping techniques specified in this paragraph for reasons of safety or representativeness shall be approved by the Type Approval Authority along with the justification for their use. In no case, however, the torque curve shall be run by descending engine speeds for governed or turbocharged engines.

7.4.5. Replicate tests

An engine need not be mapped before each and every test cycle. An engine shall be remapped prior to a test cycle if:

- (a) An unreasonable amount of time has transpired since the last map, as determined by engineering judgement; or
- (b) Physical changes or recalibrations have been made to the engine which potentially affect engine performance.

7.4.6. Denormalization of engine speed

For generating the reference cycles, the normalized speeds of Appendix 1 (WHTC) and Table 1 (WHSC) shall be denormalized using the following equation:

$$n_{ref} = n_{norm} \times (0.45 \times n_{i0} + 0.45 \times n_{pref} + 0.1 \times n_{hi} - n_{idle}) \times 2.0327 + n_{idle} \quad (9)$$

For determination of n_{pref} , the integral of the maximum torque shall be calculated from n_{idle} to n_{95h} from the engine mapping curve, as determined in accordance with paragraph 7.4.3.

The engine speeds in Figures 4 and 5 are defined, as follows:

- n_{norm} is the normalized speed in Appendix 1 and Table 1 divided by 100
- n_{lo} is the lowest speed where the power is 55 per cent of maximum power
- n_{pref} is the engine speed where the integral of max. mapped torque is 51 per cent of the whole integral between n_{idle} and n_{95h}
- n_{hi} is the highest speed where the power is 70 per cent of maximum power
- n_{idle} is the idle speed
- n_{95h} is the highest speed where the power is 95 per cent of maximum power

For engines (mainly positive ignition engines) with a steep governor droop curve, where fuel cut off does not permit to operate the engine up to n_{hi} or n_{95h} , the following provisions apply:

n_{hi} in equation 9 is replaced with $n_{P_{\text{max}}} \times 1.02$

n_{95h} is replaced with $n_{P_{\text{max}}} \times 1.02$

Figure 4:
Definition of test speeds

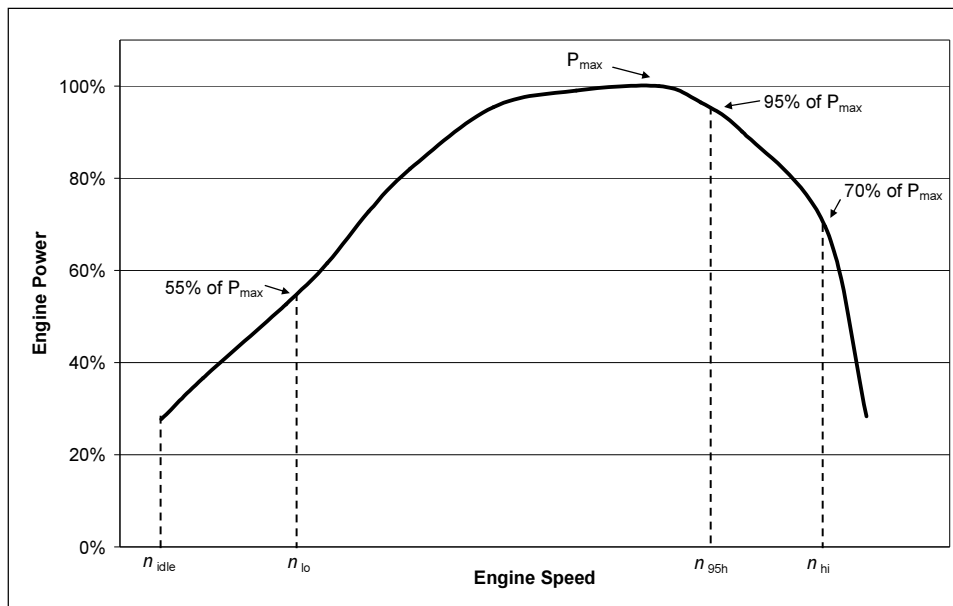
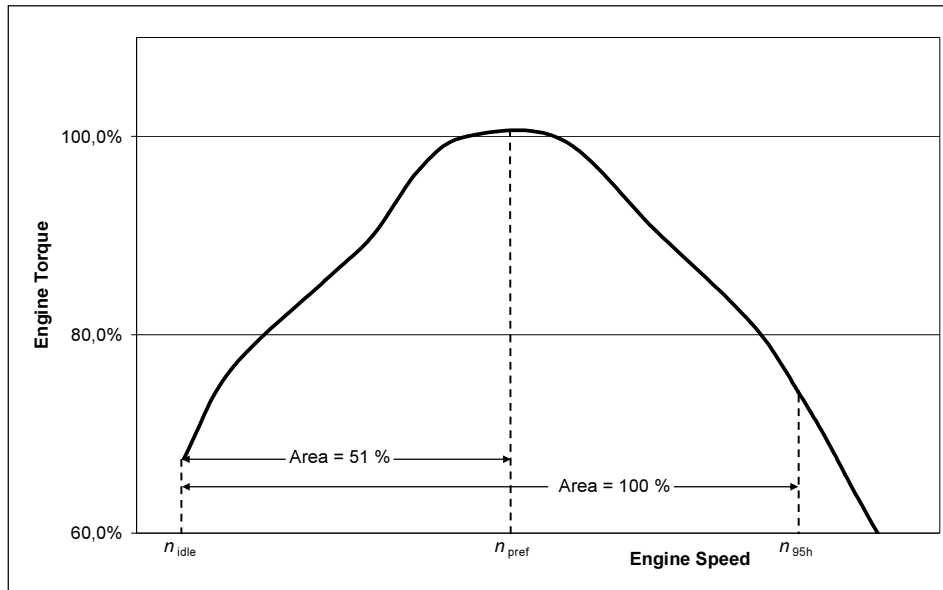

Figure 5
Definition of n_{pref}



7.4.7. Denormalization of engine torque

The torque values in the engine dynamometer schedule of Appendix 1 to this annex (WHTC) and in Table 1 (WHSC) are normalized to the maximum torque at the respective speed. For generating the reference cycles, the torque 7.4.7. Denormalization of engine torque

The torque values in the engine dynamometer schedule of Appendix 1 to this annex (WHTC) and in Table 1 (WHSC) are normalized to the maximum torque at the respective speed. For generating the reference cycles, the torque values for each individual reference speed value as determined in paragraph 7.4.6. shall be denormalized, using the mapping curve determined according to paragraph 7.4.3., as follows:

$$M_{ref,i} = \frac{M_{nom,i}}{100} \times M_{max,i} + M_{f,i} - M_{r,i}$$

Where:

$M_{nom,i}$ is the normalized torque, per cent

$M_{max,i}$ is the maximum torque from the mapping curve, Nm

$M_{f,i}$ is the torque absorbed by auxiliaries/equipment to be fitted, Nm

$M_{r,i}$ is the torque absorbed by auxiliaries/equipment to be removed, Nm

If auxiliaries/equipment are fitted in accordance with paragraph 6.3.1. and Appendix 6 to this annex, M_f and M_r are zero.

The negative torque values of the motoring points (m in Appendix 1 to this annex) shall take on, for purposes of reference cycle generation, reference values determined in either of the following ways:

- Negative 40 per cent of the positive torque available at the associated speed point;
- Mapping of the negative torque required to motor the engine from maximum to minimum mapping speed;
- Determination of the negative torque required to motor the engine at idle and at n_{hi} and linear interpolation between these two points.

7.4.8. Calculation of reference cycle work

Reference cycle work shall be determined over the test cycle by synchronously calculating instantaneous values for engine power from reference speed and reference torque, as determined in paragraphs 7.4.6. and 7.4.7. Instantaneous engine power values shall be integrated over the test cycle to calculate the reference cycle work W_{ref} (kWh). If auxiliaries are not fitted in accordance with paragraph 6.3.1., the instantaneous power values shall be corrected using equation 4 in paragraph 6.3.5.

The same methodology shall be used for integrating both reference and actual engine power. If values are to be determined between adjacent reference or adjacent measured values, linear interpolation shall be used. In integrating the actual cycle work, any negative torque values shall be set equal to zero and included. If integration is performed at a frequency of less than 5 Hz, and if, during a given time segment, the torque value changes from positive to negative or negative to positive, the negative portion shall be computed and set equal to zero. The positive portion shall be included in the integrated value.

7.5. Pre-test procedures

7.5.1. Installation of the measurement equipment

The instrumentation and sample probes shall be installed as required. The tailpipe shall be connected to the full flow dilution system, if used.

7.5.2. Preparation of measurement equipment for sampling

The following steps shall be taken before emission sampling begins:

- (a) Leak checks shall be performed within 8 hours prior to emission sampling according to paragraph 9.3.4.;
- (b) For batch sampling, clean storage media shall be connected, such as evacuated bags;
- (c) All measurement instruments shall be started according to the instrument manufacturer's instructions and good engineering judgment;
- (d) Dilution systems, sample pumps, cooling fans, and the data-collection system shall be started;
- (e) The sample flow rates shall be adjusted to desired levels, using bypass flow, if desired;
- (f) Heat exchangers in the sampling system shall be pre-heated or pre-cooled to within their operating temperature ranges for a test;
- (g) Heated or cooled components such as sample lines, filters, coolers, and pumps shall be allowed to stabilize at their operating temperatures;
- (h) Exhaust dilution system flow shall be switched on at least 10 minutes before a test sequence;
- (i) Any electronic integrating devices shall be zeroed or re-zeroed, before the start of any test interval.

7.5.3. Checking the gas analyzers

Gas analyzer ranges shall be selected. Emission analyzers with automatic or manual range switching are permitted. During the test cycle, the range of the emission analyzers shall not be switched. At the same time the gains of an analyzer's analogue operational amplifier(s) may not be switched during the test cycle.

Zero and span response shall be determined for all analyzers using internationally-traceable gases that meet the specifications of paragraph 9.3.3. FID analyzers shall be spanned on a carbon number basis of one (C1).

7.5.4. Preparation of the particulate sampling filter

At least one hour before the test, the filter shall be placed in a petri dish, which is protected against dust contamination and allows air exchange, and placed in a weighing chamber for stabilization. At the end of the stabilization period, the filter shall be weighed and the tare weight shall be recorded. The filter shall then be stored in a closed petri dish or sealed filter holder until needed for testing. The filter shall be used within eight hours of its removal from the weighing chamber.

7.5.5. Adjustment of the dilution system

The total diluted exhaust gas flow of a full flow dilution system or the diluted exhaust gas flow through a partial flow dilution system shall be set to eliminate water condensation in the system, and to obtain a filter face temperature between 315 K (42 °C) and 32 K (52°C).

7.5.6. Starting the particulate sampling system

The particulate sampling system shall be started and operated on by-pass. The particulate background level of the diluent may be determined by sampling the diluent prior to the entrance of the exhaust gas into the dilution tunnel. The measurement may be done prior to or after the test. If the measurement is done both at the beginning and at the end of the cycle, the values may be averaged. If a different sampling system is used for background measurement, the measurement shall be done in parallel to the test run.

7.6. WHTC cycle run

7.6.1. Engine cool-down

A natural or forced cool-down procedure may be applied. For forced cool-down, good engineering judgment shall be used to set up systems to send cooling air across the engine, to send cool oil through the engine lubrication system, to remove heat from the coolant through the engine cooling system, and to remove heat from an exhaust after-treatment system. In the case of a forced after-treatment system cool down, cooling air shall not be applied until the after-treatment system has cooled below its catalytic activation temperature. Any cooling procedure that results in unrepresentative emissions is not permitted.

7.6.2. Cold start test

The cold-start test shall be started when the temperatures of the engine's lubricant, coolant, and after-treatment systems are all between 293 and 303 K (20 and 30 °C). The engine shall be started using one of the following methods:

- (a) The engine shall be started as recommended in the owner's manual using a production starter motor and adequately charged battery or a suitable power supply; or
- (b) The engine shall be started by using the dynamometer. The engine shall be motored within ± 25 per cent of its typical in-use cranking speed. Cranking shall be stopped within 1 second after the engine is running. If the engine does not start after 15 seconds of cranking, cranking shall be stopped and the reason for the failure to start determined, unless the owner's manual or the service-repair manual describes the longer cranking time as normal.

7.6.3. Hot soak period

Immediately upon completion of the cold start test, the engine shall be conditioned for the hot start test using a 10 ± 1 minute hot soak period.

7.6.4. Hot start test

The engine shall be started at the end of the hot soak period as defined in paragraph 7.6.3. using the starting methods given in paragraph 7.6.2.

7.6.5. Test sequence

The test sequence of both cold start and hot start test shall commence at the start of the engine. After the engine is running, cycle control shall be initiated so that engine operation matches the first set point of the cycle.

The WHTC shall be performed according to the reference cycle as set out in paragraph 7.4. Engine speed and torque command set points shall be issued at 5 Hz (10 Hz recommended) or greater. The set points shall be calculated by linear interpolation between the 1 Hz set points of the reference cycle. Actual engine speed and torque shall be recorded at least once every second during the test cycle (1 Hz), and the signals may be electronically filtered.

7.6.6. Collection of emission relevant data

At the start of the test sequence, the measuring equipment shall be started, simultaneously:

- (a) Start collecting or analyzing diluent, if a full flow dilution system is used;
- (b) Start collecting or analyzing raw or diluted exhaust gas, depending on the method used;
- (c) Start measuring the amount of diluted exhaust gas and the required temperatures and pressures;
- (d) Start recording the exhaust gas mass flow rate, if raw exhaust gas analysis is used;
- (e) Start recording the feedback data of speed and torque of the dynamometer.

If raw exhaust measurement is used, the emission concentrations (SPN, (NM)HC, CO and NO_x) and the exhaust gas mass flow rate shall be measured continuously and stored with at least 2 Hz on a computer system. All other data may be recorded with a sample rate of at least 1 Hz. For analogue analyzers the response shall be recorded, and the calibration data may be applied online or offline during the data evaluation.

If a full flow dilution system is used, HC and NO_x shall be measured continuously in the dilution tunnel with a frequency of at least 2 Hz. The average concentrations shall be determined by integrating the analyzer signals over the test cycle. The system response time shall be no greater than 20 seconds, and shall be coordinated with CVS flow fluctuations and sampling time/test cycle offsets, if necessary. CO, CO₂, and NMHC may be determined by integration of continuous measurement signals or by analyzing the concentrations in the sample bag, collected over the cycle. The concentrations of the gaseous pollutants in the diluent shall be determined prior to the point where the exhaust enters into the dilution tunnel by integration or by collecting into the background bag. All other parameters that need to be measured shall be recorded with a minimum of one measurement per second (1 Hz).

7.6.7. Particulate sampling

At the start of the test sequence, the particulate sampling system shall be switched from by-pass to collecting particulates.

If a partial flow dilution system is used, the sample pump(s) shall be controlled, so that the flow rate through the particulate sample probe or transfer tube is maintained proportional to the exhaust mass flow rate as determined in accordance with paragraph 9.4.6.1.

If a full flow dilution system is used, the sample pump(s) shall be adjusted so that the flow rate through the particulate sample probe or transfer tube is maintained at a value within ± 2.5 per cent of the set flow rate. If flow compensation (i.e., proportional control of sample flow) is used, it shall be demonstrated that the ratio of main tunnel flow to particulate sample flow does not change by more than ± 2.5 per cent of its set value (except for the first 10 seconds of sampling). The average temperature and pressure at the gas meter(s) or flow instrumentation inlet shall be recorded. If the set flow rate cannot be maintained over the complete cycle within ± 2.5 per cent because of high particulate loading on the filter, the test shall be voided. The test shall be rerun using a lower sample flow rate.

7.6.8. Engine stalling and equipment malfunction

If the engine stalls anywhere during the cold start test, the test shall be voided. The engine shall be preconditioned and restarted according to the requirements of paragraph 7.6.2., and the test repeated.

If the engine stalls anywhere during the hot start test, the hot start test shall be voided. The engine shall be soaked according to paragraph 7.6.3., and the hot start test repeated. In this case, the cold start test need not be repeated.

If a malfunction occurs in any of the required test equipment during the test cycle, the test shall be voided and repeated in line with the above provisions.

7.7. WHSC cycle run

7.7.1. Preconditioning the dilution system and the engine

The dilution system and the engine shall be started and warmed up in accordance with paragraph 7.4.1. After warm-up, the engine and sampling system shall be preconditioned by operating the engine at mode 9 (see paragraph 7.2.2., Table 1) for a minimum of 10 minutes while simultaneously operating the dilution system. Dummy particulate emissions samples may be collected. Those sample filters need not be stabilized or weighed, and may be discarded. Flow rates shall be set at the approximate flow rates selected for testing. The engine shall be shut off after preconditioning.

7.7.2. Engine starting

5 ± 1 minutes after completion of preconditioning at mode 9 as described in paragraph 7.7.1., the engine shall be started according to the manufacturer's recommended starting procedure in the owner's manual, using either a production starter motor or the dynamometer in accordance with paragraph 7.6.2.

7.7.3. Test sequence

The test sequence shall commence after the engine is running and within one minute after engine operation is controlled to match the first mode of the cycle (idle).

The WHSC shall be performed according to the order of test modes listed in Table 1 of paragraph 7.2.2.

7.7.4. Collection of emission relevant data

At the start of the test sequence, the measuring equipment shall be started, simultaneously:

- (a) Start collecting or analyzing diluent, if a full flow dilution system is used;
- (b) Start collecting or analyzing raw or diluted exhaust gas, depending on the method used;
- (c) Start measuring the amount of diluted exhaust gas and the required temperatures and pressures;

- (d) Start recording the exhaust gas mass flow rate, if raw exhaust gas analysis is used;
- (e) Start recording the feedback data of speed and torque of the dynamometer.

If raw exhaust measurement is used, the emission concentrations (SPN, (NM)HC, CO and NO_x) and the exhaust gas mass flow rate shall be measured continuously and stored with at least 2 Hz on a computer system. All other data may be recorded with a sample rate of at least 1 Hz. For analogue analyzers the response shall be recorded, and the calibration data may be applied online or offline during the data evaluation.

If a full flow dilution system is used, HC and NO_x shall be measured continuously in the dilution tunnel with a frequency of at least 2 Hz. The average concentrations shall be determined by integrating the analyzer signals over the test cycle. The system response time shall be no greater than 20 seconds, and shall be coordinated with CVS flow fluctuations and sampling time/test cycle offsets, if necessary. CO, CO₂, and NMHC may be determined by integration of continuous measurement signals or by analyzing the concentrations in the sample bag, collected over the cycle. The concentrations of the gaseous pollutants in the diluent shall be determined prior to the point where the exhaust enters into the dilution tunnel by integration or by collecting into the background bag. All other parameters that need to be measured shall be recorded with a minimum of one measurement per second (1 Hz).

7.7.5. Particulate sampling

At the start of the test sequence, the particulate sampling system shall be switched from by-pass to collecting particulates. If a partial flow dilution system is used, the sample pump(s) shall be controlled, so that the flow rate through the particulate sample probe or transfer tube is maintained proportional to the exhaust mass flow rate as determined in accordance with paragraph 9.4.6.1.

If a full flow dilution system is used, the sample pump(s) shall be adjusted so that the flow rate through the particulate sample probe or transfer tube is maintained at a value within ± 2.5 per cent of the set flow rate. If flow compensation (i.e., proportional control of sample flow) is used, it shall be demonstrated that the ratio of main tunnel flow to particulate sample flow does not change by more than ± 2.5 per cent of its set value (except for the first 10 seconds of sampling). The average temperature and pressure at the gas meter(s) or flow instrumentation inlet shall be recorded. If the set flow rate cannot be maintained over the complete cycle within ± 2.5 per cent because of high particulate loading on the filter, the test shall be voided. The test shall be rerun using a lower sample flow rate.

7.7.6. Engine stalling and equipment malfunction

If the engine stalls anywhere during the cycle, the test shall be voided. The engine shall be preconditioned according to paragraph 7.7.1. and restarted according to paragraph 7.7.2., and the test repeated.

If a malfunction occurs in any of the required test equipment during the test cycle, the test shall be voided and repeated in line with the above provisions.

7.8. Post-test procedures

7.8.1. Operations after test

At the completion of the test, the measurement of the exhaust gas mass flow rate, the diluted exhaust gas volume, the gas flow into the collecting bags and the particulate sample pump shall be stopped. For an integrating analyser system, sampling shall continue until system response times have elapsed.

7.8.2. Verification of proportional sampling

For any proportional batch sample, such as a bag sample or PM sample, it shall be verified that proportional sampling was maintained according to paragraphs 7.6.7. and 7.7.5. Any sample that does not fulfil the requirements shall be voided.

7.8.3. PM conditioning and weighing

The particulate filter shall be placed into covered or sealed containers or the filter holders shall be closed, in order to protect the sample filters against ambient contamination. Thus protected, the filter shall be returned to the weighing chamber. The filter shall be conditioned for at least one hour, and then weighed according to paragraph 9.4.5. The gross weight of the filter shall be recorded.

7.8.4. Drift verification

As soon as practical but no later than 30 minutes after the test cycle is complete or during the soak period, the zero and span responses of the gaseous analyzer ranges used shall be determined. For the purpose of this paragraph, test cycle is defined as follows:

- (a) For the WHTC: the complete sequence cold – soak – hot;
- (b) For the WHTC hot start test (paragraph 6.6.): the sequence soak – hot;
- (c) For the multiple regeneration WHTC hot start test (paragraph 6.6.): the total number of hot start tests;
- (d) For the WHSC: the test cycle.

The following provisions apply for analyzer drift:

- (a) The pre-test zero and span and post-test zero and span responses may be directly inserted into equation 66 of paragraph 8.6.1. without determining the drift;
- (b) If the drift between the pre-test and post-test results is less than 1 per cent of full scale, the measured concentrations may be used uncorrected or may be corrected for drift according to paragraph 8.6.1.;
- (c) If the drift difference between the pre-test and post-test results is equal to or greater than 1 per cent of full scale, the test shall be voided or the measured concentrations shall be corrected for drift according to paragraph 8.6.1.

7.8.5. Analysis of gaseous bag sampling

As soon as practical, the following shall be performed:

- (a) Gaseous bag samples shall be analyzed no later than 30 minutes after the hot start test is complete or during the soak period for the cold start test;
- (b) Background samples shall be analyzed no later than 60 minutes after the hot start test is complete.

7.8.6. Validation of cycle work

Before calculating actual cycle work, any points recorded during engine starting shall be omitted. Actual cycle work shall be determined over the test cycle by synchronously using actual speed and actual torque values to calculate instantaneous values for engine power. Instantaneous engine power values shall be integrated over the test cycle to calculate the actual cycle

work W_{act} (kWh). If auxiliaries/equipment are not fitted in accordance with paragraph 6.3.1., the instantaneous power values shall be corrected using equation 4 in paragraph 6.3.5.

The same methodology as described in paragraph 7.4.8. shall be used for integrating actual engine power.

The actual cycle work W_{act} is used for comparison to the reference cycle work W_{ref} and for calculating the brake specific emissions (see paragraph 8.6.3.).

W_{act} shall be between 85 per cent and 105 per cent of W_{ref}

7.8.7. Validation statistics of the test cycle

Linear regressions of the actual values (n_{act} , M_{act} , P_{act}) on the reference values (n_{ref} , M_{ref} , P_{ref}) shall be performed for both the WHTC and the WHSC.

To minimize the biasing effect of the time lag between the actual and reference cycle values, the entire engine speed and torque actual signal sequence may be advanced or delayed in time with respect to the reference speed and torque sequence. If the actual signals are shifted, both speed and torque shall be shifted by the same amount in the same direction.

The method of least squares shall be used, with the best-fit equation having the form:

$$y = a_1x + a_0 \quad (11)$$

Where:

y is the actual value of speed (min^{-1}), torque (Nm), or power (kW)

a_1 is the slope of the regression line

x is the reference value of speed (min^{-1}), torque (Nm), or power (kW)

a_0 is the y intercept of the regression line

The standard error of estimate (SEE) of y on x and the coefficient of determination (r^2) shall be calculated for each regression line.

It is recommended that this analysis be performed at 1 Hz. For a test to be considered valid, the criteria of Table 2 (WHTC) or Table 3 (WHSC) shall be met.

Table 2
Regression line tolerances for the WHTC

	<i>Speed</i>	<i>Torque</i>	<i>Power</i>
Standard error of estimate (SEE) of y on x	maximum 5 per cent of maximum test speed	maximum 10 per cent of maximum engine torque	maximum 10 per cent of maximum engine power
Slope of the regression line, a_1	0.95 to 1.03	0.83 - 1.03	0.89 - 1.03
Coefficient of determination, r^2	minimum 0.970	minimum 0.850	minimum 0.910
y intercept of the regression line, a_0	maximum 10 per cent of idle speed	± 20 Nm or ± 2 per cent of maximum torque whichever is greater	± 4 kW or ± 2 per cent of maximum power whichever is greater

Table 3
Regression line tolerances for the WHSC

	<i>Speed</i>	<i>Torque</i>	<i>Power</i>
Standard error of estimate (SEE) of y on x	maximum 1 per cent of maximum test speed	maximum 2 per cent of maximum engine torque	maximum 2 per cent of maximum engine power
Slope of the regression line, a_1	0.99 to 1.01	0.98 - 1.02	0.98 - 1.02

Coefficient of determination, r^2	minimum 0.990	minimum 0.950	minimum 0.950
y intercept of the regression line, a_0	maximum 1 per cent of maximum test speed	± 20 Nm or ± 2 per cent of maximum torque whichever is greater	± 4 kW or ± 2 per cent of maximum power whichever is greater

For regression purposes only, point omissions are permitted where noted in Table 4 before doing the regression calculation. However, those points shall not be omitted for the calculation of cycle work and emissions. Point omission may be applied to the whole or to any part of the cycle.

Table 4
Permitted point omissions from regression analysis

<i>Event</i>	<i>Conditions</i>	<i>Permitted point omissions</i>
Minimum operator demand (idle point)	$n_{ref} = 0$ per cent and $M_{ref} = 0$ per cent and $M_{act} > (M_{ref} - 0.02 M_{max. mapped torque})$ and $M_{act} < (M_{ref} + 0.02 M_{max. mapped torque})$	speed and power
Minimum operator demand (motoring point)	$M_{ref} < 0$ per cent	power and torque
Minimum operator demand	$n_{act} \leq 1.02 n_{ref}$ and $M_{act} > M_{ref}$ or $n_{act} > n_{ref}$ and $M_{act} \leq M_{ref}$ or $n_{act} > 1.02 n_{ref}$ and $M_{ref} < M_{act} \leq (M_{ref} + 0.02 M_{max. mapped torque})$	power and either torque or speed
Maximum operator demand	$n_{act} < n_{ref}$ and $M_{act} \geq M_{ref}$ or $n_{act} \geq 0.98 n_{ref}$ and $M_{act} < M_{ref}$ or $n_{act} < 0.98 n_{ref}$ and $M_{ref} > M_{act} \geq (M_{ref} - 0.02 M_{max. mapped torque})$	power and either torque or speed

8. Emission calculation

The final test result shall be rounded in one step to the number of places to the right of the decimal point indicated by the applicable emission standard plus one additional significant figure, in accordance with ASTM E 29-06B. No rounding of intermediate values leading to the final break-specific emission result is permitted.

Calculation of hydrocarbons and/or non-methane hydrocarbons is based on the following molar carbon/hydrogen/oxygen ratios (C/H/O) of the fuel:

$CH_{1.86}O_{0.006}$ for diesel (B7),

$CH_{2.92}O_{0.46}$ for ethanol for dedicated C.I. engines (ED95),

$CH_{1.93}O_{0.032}$ for petrol (E10),

$CH_{2.74}O_{0.385}$ for ethanol (E85),

$CH_{2.525}$ for LPG (liquefied petroleum gas),

CH₄ for NG (natural gas) and biomethane.

Examples of the calculation procedures are given in Appendix 5 to this annex.

Emissions calculation on a molar basis, in accordance with Annex 7 of gtr No. 11 concerning the exhaust emission test protocol for Non-Road Mobile Machinery (NRMM), is permitted with the prior agreement of the Type Approval Authority.

8.1. Dry/wet correction

If the emissions are measured on a dry basis, the measured concentration shall be converted to a wet basis according to the following equation:

$$c_w = k_w \times c_d \quad (12)$$

Where:

c_d is the dry concentration in ppm or per cent volume

k_w is the dry/wet correction factor ($k_{w,a}$, $k_{w,e}$, or $k_{w,d}$ depending on respective equation used)

8.1.1. Raw exhaust gas

$$k_{w,a} = \left(1 - \frac{1,2442 \times H_a + 111,19 \times w_{ALF} \times \frac{q_{mf,i}}{q_{mad,i}}}{773,4 + 1,2442 \times H_a + \frac{q_{mf,i}}{q_{mad,i}} \times k_f \times 1\,000} \right) \times 1,008 \quad (13)$$

or

$$k_{w,a} = \left(1 - \frac{1,2442 \times H_a + 111,19 \times w_{ALF} \times \frac{q_{mf,i}}{q_{mad,i}}}{773,4 + 1,2442 \times H_a + \frac{q_{mf,i}}{q_{mad,i}} \times k_f \times 1\,000} \right) \left(1 - \frac{P_r}{P_b} \right) \quad (14)$$

or

$$k_{w,a} = \left(1 - \frac{1}{1 + a \times 0,005 \times (c_{CO_2} + c_{CO})} - k_{w1} \right) \times 1,008 \quad (15)$$

With

$$k_{fw} = 0,055594 \times W_{ALF} + 0,0080021 \times W_{DEL} + 0,0070046 \times W_{EPS} \quad (16)$$

and

$$k_{w1} = \frac{1,608 \times H_a}{1,000 + (1,608 \times H_a)} \quad (17)$$

Where:

H_a is the intake air humidity, g water per kg dry air

w_{ALF} is the hydrogen content of the fuel, per cent mass

$q_{mf,i}$ is the instantaneous fuel mass flow rate, kg/s

$q_{mad,i}$ is the instantaneous dry intake air mass flow rate, kg/s

p_r is the water vapour pressure after cooling bath, kPa

p_b is the total atmospheric pressure, kPa

W_{DEL} is the nitrogen content of the fuel, per cent mass

w_{EPS} is the oxygen content of the fuel, per cent mass

α is the molar hydrogen ratio of the fuel

c_{CO_2} is the dry CO₂ concentration, per cent

c_{CO} is the dry CO concentration, per cent

Equations 13 and 14 are principally identical with the factor 1.008 in equations 13 and 15 being an approximation for the more accurate denominator in equation 14.

8.1.2. Diluted exhaust gas

$$k_{w,e} = \left[\left(1 - \frac{\alpha \times c_{CO_2w}}{200} \right) - k_{w2} \right] \times 1.008 \quad (18)$$

or

$$k_{w,e} = \left[\frac{(1 - k_{w2})}{1 + \frac{\alpha \times c_{CO_2d}}{200}} \right] \times 1.008 \quad (19)$$

With

$$k_{w2} = \frac{1.608 \times \left[H_d \times \left(1 - \frac{1}{D} \right) + H_a \times \left(\frac{1}{D} \right) \right]}{1,000 + \left\{ 1.608 \times \left[H_d \times \left(1 - \frac{1}{D} \right) + H_a \times \left(\frac{1}{D} \right) \right] \right\}} \quad (20)$$

Where:

α is the molar hydrogen ratio of the fuel

c_{CO_2w} is the wet CO₂ concentration, per cent

c_{CO_2d} is the dry CO₂ concentration, per cent

H_d is the diluent humidity, g water per kg dry air

H_a is the intake air humidity, g water per kg dry air

D is the dilution factor (see paragraph 8.5.2.3.2.)

8.1.3. Diluent

$$k_{w,d} = (1 - k_{w3}) \times 1.008 \quad (21)$$

With

$$k_{w3} = \frac{1.608 \times H_d}{1,000 + (1.608 \times H_d)} \quad (22)$$

Where:

H_d is the diluent humidity, g water per kg dry air

8.2. NO_x correction for humidity

As the NO_x emission depends on ambient air conditions, the NO_x concentration shall be corrected for humidity with the factors given in paragraph 8.2.1. or 8.2.2. The intake air humidity H_a may be derived from relative humidity measurement, dew point measurement, vapour pressure measurement or dry/wet bulb measurement using generally accepted equations.

8.2.1. Compression-ignition engines

$$k_{h,D} = \frac{15,698 \times H_a}{1\,000} + 0,832 \quad (23)$$

Where:

H_a is the intake air humidity, g water per kg dry air

8.2.2. Positive ignition engines

$$k_{h,G} = 0,6272 + 44,030 \times 10^{-3} \times H_a - 0,862 \times 10^{-3} \times H_a^2 \quad (24)$$

Where:

H_a is the intake air humidity, g water per kg dry air

8.3. Particulate filter buoyancy correction

The sampling filter mass shall be corrected for its buoyancy in air. The buoyancy correction depends on sampling filter density, air density and the density of the balance calibration weight, and does not account for the buoyancy of the PM itself. The buoyancy correction shall be applied to both tare filter mass and gross filter mass.

If the density of the filter material is not known, the following densities shall be used:

- (a) Teflon coated glass fiber filter: 2,300 kg/m³;
- (b) Teflon membrane filter: 2,144 kg/m³;
- (c) Teflon membrane filter with polymethylpentene support ring: 920 kg/m³.

For stainless steel calibration weights, a density of 8,000 kg/m³ shall be used. If the material of the calibration weight is different, its density shall be known.

The following equation shall be used:

$$m_f = m_{\text{uncor}} \times \left(\frac{1 - \frac{\rho_a}{\rho_w}}{1 - \frac{\rho_a}{\rho_f}} \right) \quad (25)$$

With

$$\rho_a = \frac{p_b \times 28,836}{8,3144 \times T_a} \quad (26)$$

Where:

m_{uncor} is the uncorrected particulate filter mass, mg

ρ_a is the density of the air, kg/m³

ρ_w is the density of balance calibration weight, kg/m³

ρ_f is the density of the particulate sampling filter, kg/m³

p_b is the total atmospheric pressure, kPa

T_a is the air temperature in the balance environment, K

28.836 is the molar mass of the air at reference humidity (282.5 K), g/mol

8.3144 is the molar gas constant

The particulate sample mass m_p used in paragraphs 8.4.3. and 8.5.3. shall be calculated as follows:

$$m_p = m_{f,G} - m_{f,T} \tag{27}$$

Where:

$m_{f,G}$ is the buoyancy corrected gross particulate filter mass, mg

$m_{f,T}$ is the buoyancy corrected tare particulate filter mass, mg

8.4. Partial flow dilution (PFS) and raw gaseous measurement

The instantaneous concentration signals of the gaseous components are used for the calculation of the mass emissions by multiplication with the instantaneous exhaust mass flow rate. The exhaust mass flow rate may be measured directly, or calculated using the methods of intake air and fuel flow measurement, tracer method or intake air and air/fuel ratio measurement. Special attention shall be paid to the response times of the different instruments. These differences shall be accounted for by time aligning the signals. For particulates, the exhaust mass flow rate signals are used for controlling the partial flow dilution system to take a sample proportional to the exhaust mass flow rate. The quality of proportionality shall be checked by applying a regression analysis between sample and exhaust flow in accordance with paragraph 9.4.6.1. The complete test set up is schematically shown in Figure 6.

Figure 6
Scheme of raw/partial flow measurement system

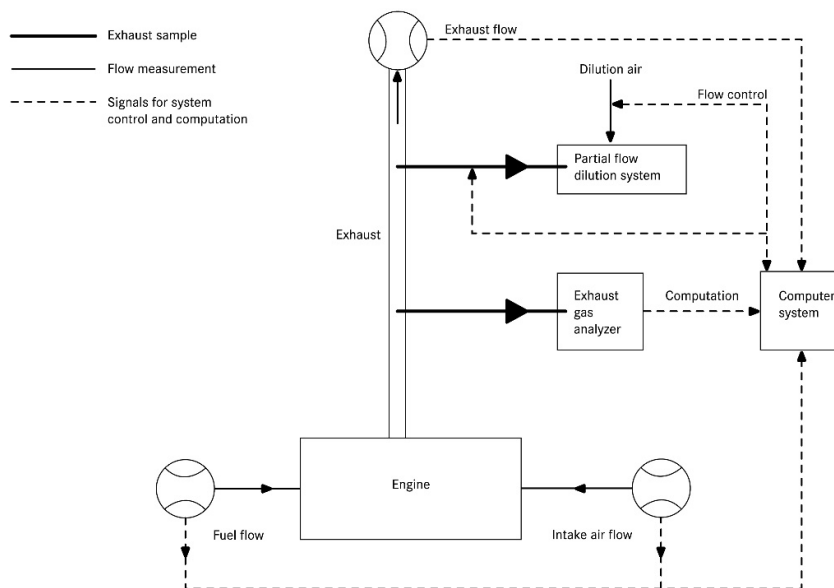

8.4.1. Determination of exhaust gas mass flow

8.4.1.1. Introduction

For calculation of the emissions in the raw exhaust gas and for controlling of a partial flow dilution system, it is necessary to know the exhaust gas mass flow rate. For the determination of the exhaust mass flow rate, one of the methods described in paragraphs 8.4.1.3. to 8.4.1.7. may be used.

If necessary for calculations of exhaust emissions, the exhaust flow rate shall be corrected for any extracted flows. If applicable, the results of the full dilution tunnel shall be corrected for the extracted flow rate unless:

$$Q(\text{extracted}) < 0.5\% \text{ of cycle mean exhaust flow rate}$$

In this case the correction is optional.

8.4.1.2. Response time

For the purpose of emissions calculation, the response time of any of the methods described in paragraphs 8.4.1.3. to 8.4.1.7. shall be equal to or less than the analyzer response time of ≤ 10 seconds, as required in paragraph 9.3.5.

For the purpose of controlling of a partial flow dilution system, a faster response is required. For partial flow dilution systems with online control, the response time shall be ≤ 0.3 second. For partial flow dilution systems with look ahead control based on a pre-recorded test run, the response time of the exhaust flow measurement system shall be ≤ 5 seconds with a rise time of ≤ 1 second. The system response time shall be specified by the instrument manufacturer. The combined response time requirements for the exhaust gas flow and partial flow dilution system are indicated in paragraph 9.4.6.1.

8.4.1.3. Direct measurement method

Direct measurement of the instantaneous exhaust flow shall be done by systems, such as:

- (a) Pressure differential devices, like flow nozzle, (details see ISO 5167);
- (b) Ultrasonic flowmeter;
- (c) Vortex flowmeter.

Precautions shall be taken to avoid measurement errors which will impact emission value errors. Such precautions include the careful installation of the device in the engine exhaust system according to the instrument manufacturers' recommendations and to good engineering practice. Especially, engine performance and emissions shall not be affected by the installation of the device.

The flowmeters shall meet the linearity requirements of paragraph 9.2.

8.4.1.4. Air and fuel measurement method

This involves measurement of the airflow and the fuel flow with suitable flowmeters. The calculation of the instantaneous exhaust gas flow shall be as follows:

$$q_{mew,i} = q_{maw,i} + q_{mf,i} \quad (28)$$

Where:

$q_{mew,i}$ is the instantaneous exhaust mass flow rate, kg/s

$q_{maw,i}$ is the instantaneous intake air mass flow rate, kg/s

$q_{mf,i}$ is the instantaneous fuel mass flow rate, kg/s

The flowmeters shall meet the linearity requirements of paragraph 9.2., but shall be accurate enough to also meet the linearity requirements for the exhaust gas flow.

8.4.1.5. Tracer measurement method

This involves measurement of the concentration of a tracer gas in the exhaust.

A known amount of an inert gas (e.g. pure helium) shall be injected into the exhaust gas flow as a tracer. The gas is mixed and diluted by the exhaust gas, but shall not react in the exhaust pipe. The concentration of the gas shall then be measured in the exhaust gas sample.

In order to ensure complete mixing of the tracer gas, the exhaust gas sampling probe shall be located at least 1 m or 30 times the diameter of the exhaust pipe, whichever is larger, downstream of the tracer gas injection point. The sampling probe may be located closer to the injection point if complete mixing is verified

by comparing the tracer gas concentration with the reference concentration when the tracer gas is injected upstream of the engine.

The tracer gas flow rate shall be set so that the tracer gas concentration at engine idle speed after mixing becomes lower than the full scale of the trace gas analyzer.

The calculation of the exhaust gas flow shall be as follows:

$$q_{mew,i} = \frac{q_{vt} \times \rho_e}{60 \times (c_{mix,i} - c_b)} \quad (29)$$

Where:

$q_{mew,i}$ is the instantaneous exhaust mass flow rate, kg/s

q_{vt} is tracer gas flow rate, cm³/min

$c_{mix,i}$ is the instantaneous concentration of the tracer gas after mixing, ppm

ρ_e is the density of the exhaust gas, kg/m³ (see Table 5)

c_b is the background concentration of the tracer gas in the intake air, ppm

The background concentration of the tracer gas (c_b) may be determined by averaging the background concentration measured immediately before the test run and after the test run.

When the background concentration is less than 1 per cent of the concentration of the tracer gas after mixing ($c_{mix,i}$) at maximum exhaust flow, the background concentration may be neglected.

The total system shall meet the linearity requirements for the exhaust gas flow of paragraph 9.2.

8.4.1.6. Airflow and air to fuel ratio measurement method

This involves exhaust mass calculation from the air flow and the air to fuel ratio. The calculation of the instantaneous exhaust gas mass flow is as follows:

$$q_{mew,i} = q_{maw,i} \times \left(1 + \frac{1}{A/F_{st} \times \lambda_i} \right) \quad (30)$$

With

$$A/F_{st} = \frac{138,0 \times \left(1 + \frac{\alpha}{4} - \frac{\varepsilon}{2} + \gamma \right)}{12,011 + 1,00794 \times \alpha + 15,9994 \times \varepsilon + 14,0067 \times \delta + 32,065 \times \gamma} \quad (31)$$

$$\lambda_i = \frac{\left(100 - \frac{c_{COd} \times 10^{-4}}{2} - c_{HCw} \times 10^{-4} \right) + \left(\frac{\alpha}{4} \times \frac{1 - \frac{2 \times c_{COd} \times 10^{-4}}{3,5 \times c_{CO2d}}}{1 + \frac{c_{CO} \times 10^{-4}}{3,5 \times c_{CO2d}}} - \frac{\varepsilon}{2} - \frac{\delta}{2} \right) \times (c_{CO2d} + c_{COd} \times 10^{-4})}{4,764 \times \left(1 + \frac{\alpha}{4} - \frac{\varepsilon}{2} + \gamma \right) \times (c_{CO2d} + c_{COd} \times 10^{-4} + c_{HCw} \times 10^{-4})} \quad (32)$$

Where:

$q_{maw,i}$ is the instantaneous intake air mass flow rate, kg/s

A/F_{st} is the stoichiometric air to fuel ratio, kg/kg

λ_i is the instantaneous excess air ratio

c_{CO2d} is the dry CO₂ concentration, per cent

c_{COd} is the dry CO concentration, ppm

c_{HCw} is the wet HC concentration, ppm

Air flow meter and analyzers shall meet the linearity requirements of paragraph 9.2., and the total system shall meet the linearity requirements for the exhaust gas flow of paragraph 9.2.

If an air to fuel ratio measurement equipment such as a zirconia type sensor is used for the measurement of the excess air ratio, it shall meet the specifications of paragraph 9.3.2.7.

8.4.1.7. Carbon balance method

This involves exhaust mass calculation from the fuel flow and the gaseous exhaust components that include carbon. The calculation of the instantaneous exhaust gas mass flow is as follows:

$$q_{mew,i} = q_{mf,i} \times \left(\frac{w_{BET}^2 \times 1.4}{(1.0828 \times w_{BET} + k_{fd} \times k_c)} \times k_c \left(1 + \frac{H_a}{1000} \right) + 1 \right) \quad (33)$$

With

$$k_c = (c_{CO2d} - c_{CO2d,a}) \times 0,5441 + \frac{c_{COd}}{18522} + \frac{c_{HCw}}{17355} \quad (34)$$

And

$$k_{fd} = -0,055586 \times w_{ALF} + 0,0080021 \times w_{DEL} + 0,0070046 \times w_{EPS} \quad (35)$$

Where:

$q_{mf,i}$ is the instantaneous fuel mass flow rate, kg/s

H_a is the intake air humidity, g water per kg dry air

w_{BET} is the carbon content of the fuel, per cent mass

w_{ALF} is the hydrogen content of the fuel, per cent mass

w_{DEL} is the nitrogen content of the fuel, per cent mass

w_{EPS} is the oxygen content of the fuel, per cent mass

c_{CO2d} is the dry CO₂ concentration, per cent

$c_{CO2d,a}$ is the dry CO₂ concentration of the intake air, per cent

c_{CO} is the dry CO concentration, ppm

c_{HCw} is the wet HC concentration, ppm

8.4.2. Determination of the gaseous components

8.4.2.1. Introduction

The gaseous components in the raw exhaust gas emitted by the engine submitted for testing shall be measured with the measurement and sampling systems described in paragraph 9.3. and Appendix 2 to this annex. The data evaluation is described in paragraph 8.4.2.2.

Two calculation procedures are described in paragraphs 8.4.2.3. and 8.4.2.4., which are equivalent for the reference fuel of Annex 5. The procedure in paragraph 8.4.2.3. is more straightforward, since it uses tabulated u values for the ratio between component and exhaust gas density. The procedure in paragraph 8.4.2.4. is more accurate for fuel qualities that deviate from the specifications in Annex 5, but requires elementary analysis of the fuel composition.

8.4.2.2. Data evaluation

The emission relevant data shall be recorded and stored in accordance with paragraph 7.6.6.

For calculation of the mass emission of the gaseous components, the traces of the recorded concentrations and the trace of the exhaust gas mass flow rate shall be time aligned by the transformation time as defined in paragraph 3.1. Therefore, the response time of the exhaust gas mass flow system and each gaseous emissions analyzer shall be determined according to paragraphs 8.4.1.2. and 9.3.5., respectively, and recorded.

8.4.2.3. Calculation of mass emission based on tabulated values

The mass of the pollutants (g/test) shall be determined by calculating the instantaneous mass emissions from the raw concentrations of the pollutants and the exhaust gas mass flow, aligned for the transformation time as determined in accordance with paragraph 8.4.2.2., integrating the instantaneous values over the cycle, and multiplying the integrated values with the u values from Table 5. If measured on a dry basis, the dry/wet correction according to paragraph 8.1. shall be applied to the instantaneous concentration values before any further calculation is done.

For the calculation of NO_x, the mass emission shall be multiplied, where applicable, with the humidity correction factor $k_{h,D}$, or $k_{h,G}$, as determined according to paragraph 8.2.

The following equation shall be applied:

$$m_{gas} = u_{gas} \times \sum_{i=1}^{i=n} \left(c_{gas,i} \times q_{mew,i} \times \frac{1}{f} \right) \quad (\text{in g/test}) \quad (36)$$

Where:

u_{gas} is the respective value of the exhaust component from Table 5

$c_{gas,i}$ is the instantaneous concentration of the component in the exhaust gas, ppm

$q_{mew,i}$ is the instantaneous exhaust mass flow, kg/s

f is the data sampling rate, Hz

n is the number of measurements

Table 5
Raw exhaust gas u values and component densities

Fuel	ρ_e	Gas					
		NO_x	CO	HC	CO_2	O_2	CH_4
		$\rho_{gas} [kg/m^3]$					
		2.053	1.250	^a	1.9636	1.4277	0.716
u_{gas}^b							
Diesel (B7)	1.2943	0.001586	0.000966	0.000482	0.001517	0.001103	0.000553
Ethanol (ED95)	1.2768	0.001609	0.000980	0.000780	0.001539	0.001119	0.000561
CNG ^c	1.2661	0.001621	0.000987	0.000528 ^d	0.001551	0.001128	0.000565
Propane	1.2805	0.001603	0.000976	0.000512	0.001533	0.001115	0.000559
Butane	1.2832	0.001600	0.000974	0.000505	0.001530	0.001113	0.000558
LPG ^e	1.2811	0.001602	0.000976	0.000510	0.001533	0.001115	0.000559
Petrol (E10)	1.2931	0.001587	0.000966	0.000499	0.001518	0.001104	0.000553
Ethanol (E85)	1.2797	0.001604	0.000977	0.000730	0.001534	0.001116	0.000559
^a depending on fuel ^b at $\lambda = 2$, dry air, 273 K, 101.3 kPa ^c u accurate within 0.2 % for mass composition of: C = 66 - 76 %; H = 22 - 25 %; N = 0 - 12 % ^d NMHC on the basis of $CH_{2.93}$ (for total HC the u_{gas} coefficient of CH_4 shall be used) ^e u accurate within 0.2 % for mass composition of: C3 = 70 - 90 %; C4 = 10 - 30 %							

8.4.2.4. Calculation of mass emission based on exact equations

The mass of the pollutants (g/test) shall be determined by calculating the instantaneous mass emissions from the raw concentrations of the pollutants, the u values and the exhaust gas mass flow, aligned for the transformation time as determined in accordance with paragraph 8.4.2.2. and integrating the instantaneous values over the cycle. If measured on a dry basis, the dry/wet correction according to paragraph 8.1. shall be applied to the instantaneous concentration values before any further calculation is done.

For the calculation of NO_x , the mass emission shall be multiplied with the humidity correction factor $k_{h,D}$, or $k_{h,G}$, as determined according to paragraph 8.2.

The following equation shall be applied:

$$m_{gas} = \sum_{i=1}^{i=n} \left(u_{gas,i} \times c_{gas,i} \times q_{mew,i} \times \frac{1}{f} \right) \text{ (in g/test)} \quad (37)$$

Where:

u_{gas} is calculated from equation 38 or 39

$c_{gas,i}$ is the instantaneous concentration of the component in the exhaust gas, ppm

$q_{mew,i}$ is the instantaneous exhaust mass flow, kg/s

f is the data sampling rate, Hz

n is the number of measurements

The instantaneous u values shall be calculated as follows:

$$u_{gas,i} = M_{gas} / (M_{e,i} \times 1,000) \quad (38)$$

or

$$u_{\text{gas},i} = \rho_{\text{gas}} / (\rho_{e,i} \times 1,000) \quad (39)$$

With

$$\rho_{\text{gas}} = M_{\text{gas}} / 22.414 \quad (40)$$

Where:

M_{gas} is the molar mass of the gas component, g/mol (see Appendix 5 to this annex)

$M_{e,i}$ is the instantaneous molar mass of the exhaust gas, g/mol

ρ_{gas} is the density of the gas component, kg/m³

$\rho_{e,i}$ is the instantaneous density of the exhaust gas, kg/m³

The molar mass of the exhaust, M_e , shall be derived for a general fuel composition $\text{CH}_\alpha\text{O}_\varepsilon\text{N}_\delta\text{S}_\gamma$ under the assumption of complete combustion, as follows:

$$M_{e,i} = \frac{1 + \frac{q_{mf,i}}{q_{maw,i}}}{\frac{q_{mf,i}}{q_{maw,i}} \times \frac{\frac{\alpha}{4} + \frac{\varepsilon}{2} + \frac{\delta}{2}}{12,011 + 1,00794 \times \alpha + 15,9994 \times \varepsilon + 14,0067 \times \delta + 32,065 \times \gamma} + \frac{\frac{H_a \times 10^{-3}}{2 \times 1,00794 + 15,9994} + \frac{1}{M_a}}{1 + H_a \times 10^{-3}}} \quad (41)$$

Where:

$q_{maw,i}$ is the instantaneous intake air mass flow rate on wet basis, kg/s

$q_{mf,i}$ is the instantaneous fuel mass flow rate, kg/s

H_a is the intake air humidity, g water per kg dry air

M_a is the molar mass of the dry intake air = 28.965 g/mol

The exhaust density ρ_e shall be derived, as follows:

$$\rho_{e,i} = \frac{1,000 + H_a + 1,000 \times (q_{mf,i}/q_{mad,i})}{773.4 + 1.2434 \times H_a + k_{fw} \times 1,000 \times (q_{mf,i}/q_{mad,i})} \quad (42)$$

Where:

$q_{mad,i}$ is the instantaneous intake air mass flow rate on dry basis, kg/s

$q_{mf,i}$ is the instantaneous fuel mass flow rate, kg/s

H_a is the intake air humidity, g water per kg dry air

k_{fw} is the fuel specific factor of wet exhaust (equation 16) in paragraph 8.1.1.

8.4.3. Particulate determination

8.4.3.1. Data evaluation

The particulate mass shall be calculated according to equation 27 of paragraph 8.3. For the evaluation of the particulate concentration, the total sample mass (m_{sep}) through the filter over the test cycle shall be recorded.

With the prior approval of the Type Approval Authority, the particulate mass may be corrected for the particulate level of the diluent, as determined in paragraph 7.5.6., in line with good engineering practice and the specific design features of the particulate measurement system used.

8.4.3.2. Calculation of mass emission

Depending on system design, the mass of particulates (g/test) shall be calculated by either of the methods in paragraph 8.4.3.2.1. or 8.4.3.2.2. after buoyancy correction of the particulate sample filter according to paragraph 8.3.

8.4.3.2.1. Calculation based on sample ratio

$$m_{PM} = m_p / (r_s \times 1,000) \quad (43)$$

Where:

m_p is the particulate mass sampled over the cycle, mg

r_s is the average sample ratio over the test cycle

With

$$r_s = \frac{m_{se}}{m_{ew}} \times \frac{m_{sep}}{m_{sed}} \quad (44)$$

Where:

m_{se} is the sample mass over the cycle, kg

m_{ew} is the total exhaust mass flow over the cycle, kg

m_{sep} is the mass of diluted exhaust gas passing the particulate collection filters, kg

m_{sed} is the mass of diluted exhaust gas passing the dilution tunnel, kg

In case of the total sampling type system, m_{sep} and m_{sed} are identical.

8.4.3.2.2. Calculation based on dilution ratio

$$m_{PM} = \frac{m_p}{m_{sep}} \times \frac{m_{edf}}{1,000} \quad (45)$$

Where:

m_p is the particulate mass sampled over the cycle, mg

m_{sep} is the mass of diluted exhaust gas passing the particulate collection filters, kg

m_{edf} is the mass of equivalent diluted exhaust gas over the cycle, kg

The total mass of equivalent diluted exhaust gas mass over the cycle shall be determined as follows:

$$m_{edf} = \sum_{i=1}^{i=n} q_{medf,i} \times \frac{1}{f} \quad (46)$$

$$q_{medf,i} = q_{mew,i} \times r_{d,i} \quad (47)$$

$$r_{d,i} = \frac{q_{mdew,i}}{(q_{mdew,i} - q_{mdw,i})} \quad (48)$$

Where:

$q_{medf,i}$ is the instantaneous equivalent diluted exhaust mass flow rate, kg/s

$q_{mew,i}$ is the instantaneous exhaust mass flow rate, kg/s

$r_{d,i}$ is the instantaneous dilution ratio

$q_{mdew,i}$ is the instantaneous diluted exhaust mass flow rate, kg/s

$q_{mdw,i}$ is the instantaneous diluent mass flow rate, kg/s

f is the data sampling rate, Hz

$$m_{ed} = 1,293 \times V_0 \times n_p \times p_p \times 273 / (101,3 \times T) \quad (49)$$

Where:

V_0 is the volume of gas pumped per revolution under test conditions, m³/rev

n_p is the total revolutions of pump per test

p_p is the absolute pressure at pump inlet, kPa

T is the average temperature of the diluted exhaust gas at pump inlet, K

If a system with flow compensation is used (i.e. without heat exchanger), the instantaneous mass emissions shall be calculated and integrated over the cycle. In this case, the instantaneous mass of the diluted exhaust gas shall be calculated as follows:

$$m_{ed,i} = 1.293 \times V_0 \times n_{p,i} \times p_p \times 273 / (101.3 \times T) \quad (50)$$

Where:

$n_{p,i}$ is the total revolutions of pump per time interval

8.5.1.3. CFV-CVS system

The calculation of the mass flow over the cycle is as follows, if the temperature of the diluted exhaust is kept within ± 11 K over the cycle by using a heat exchanger:

$$m_{ed} = 1.293 \times t \times K_V \times p_p / T^{0.5} \quad (51)$$

Where:

t is the cycle time, s

K_V is the calibration coefficient of the critical flow venturi for standard conditions,

p_p is the absolute pressure at venturi inlet, kPa

T is the absolute temperature at venturi inlet, K

If a system with flow compensation is used (i.e. without heat exchanger), the instantaneous mass emissions shall be calculated and integrated over the cycle. In this case, the instantaneous mass of the diluted exhaust gas shall be calculated as follows:

$$m_{ed,i} = 1.293 \times \Delta t_i \times K_V \times p_p / T^{0.5} \quad (52)$$

Where:

Δt_i is the time interval, s

8.5.1.4. SSV-CVS system

The calculation of the mass flow over the cycle shall be as follows, if the temperature of the diluted exhaust is kept within ± 11 K over the cycle by using a heat exchanger:

$$m_{ed} = 1.293 \times Q_{SSV} \quad (53)$$

With

$$Q_{SSV} = \frac{A_0}{60} d_V^2 C_d p_p \sqrt{\left[\frac{1}{T} (r_p^{1.4286} - r_p^{1.7143}) \cdot \left(\frac{1}{1 - r_p^{1.4286}} \right) \right]} \quad (54)$$

Where:

A_0 is 0.005692 in SI units of $\left(\frac{m^3}{min}\right)\left(\frac{K^{\frac{1}{2}}}{kPa}\right)\left(\frac{1}{mm^2}\right)$

d_V is the diameter of the SSV throat, mm

C_d is the discharge coefficient of the SSV

p_p is the absolute pressure at venturi inlet, kPa

T is the temperature at the venturi inlet, K

r_p is the ratio of the SSV throat to inlet absolute static pressure, $1 - \frac{\Delta p}{P_a}$

r_D is the ratio of the SSV throat diameter, d , to the inlet pipe inner diameter D

If a system with flow compensation is used (i.e. without heat exchanger), the instantaneous mass emissions shall be calculated and integrated over the cycle. In this case, the instantaneous mass of the diluted exhaust gas shall be calculated as follows:

$$m_{ed} = 1.293 \times Q_{SSV} \times \Delta t_i \quad (55)$$

Where:

Δt_i is the time interval, s

The real time calculation shall be initialized with either a reasonable value for C_d , such as 0.98, or a reasonable value of Q_{SSV} . If the calculation is initialized with Q_{SSV} , the initial value of Q_{SSV} shall be used to evaluate the Reynolds number.

During all emissions tests, the Reynolds number at the SSV throat shall be in the range of Reynolds numbers used to derive the calibration curve developed in paragraph 9.5.4.

8.5.2. Determination of the gaseous components

8.5.2.1. Introduction

The gaseous components in the diluted exhaust gas emitted by the engine submitted for testing shall be measured by the methods described in Appendix 2 to this annex. Dilution of the exhaust shall be done with filtered ambient air, synthetic air or nitrogen. The flow capacity of the full flow system shall be large enough to completely eliminate water condensation in the dilution and sampling systems. Data evaluation and calculation procedures are described in paragraphs 8.5.2.2. and 8.5.2.3.

8.5.2.2. Data evaluation

The emission relevant data shall be recorded and stored in accordance with paragraph 7.6.6.

8.5.2.3. Calculation of mass emission

8.5.2.3.1. Systems with constant mass flow

For systems with heat exchanger, the mass of the pollutants shall be determined from the following equation:

$$m_{gas} = u_{gas} \times c_{gas} \times m_{ed} \text{ (in g/test)} \quad (56)$$

Where:

u_{gas} is the respective value of the exhaust component from Table 6

c_{gas} is the average background corrected concentration of the component, ppm

m_{ed} is the total diluted exhaust mass over the cycle, kg

If measured on a dry basis, the dry/wet correction according to paragraph 8.1. shall be applied.

For the calculation of NO_x , the mass emission shall be multiplied, if applicable, with the humidity correction factor $k_{\text{h,D}}$, or $k_{\text{h,G}}$, as determined according to paragraph 8.2.

The u values are given in Table 6. For calculating the u_{gas} values, the density of the diluted exhaust gas has been assumed to be equal to air density. Therefore, the u_{gas} values are identical for single gas components, but different for HC.

Table 6
Diluted exhaust gas u values and component densities

Fuel	ρ_{de}	Gas					
		NO_x	CO	HC	CO_2	O_2	CH_4
		ρ_{gas} [kg/m^3]					
		2.053	1.250	^a	1.9636	1.4277	0.716
u_{gas} ^b							
Diesel (B7)	1.293	0.001588	0.000967	0.000483	0.001519	0.001104	0.000553
Ethanol (ED95)	1.293	0.001588	0.000967	0.000770	0.001519	0.001104	0.000553
CNG ^c	1.293	0.001588	0.000967	0.000517 ^d	0.001519	0.001104	0.000553
Propane	1.293	0.001588	0.000967	0.000507	0.001519	0.001104	0.000553
Butane	1.293	0.001588	0.000967	0.000501	0.001519	0.001104	0.000553
LPG ^e	1.293	0.001588	0.000967	0.000505	0.001519	0.001104	0.000553
Petrol (E10)	1.293	0.001588	0.000967	0.000499	0.001519	0.001104	0.000554
Ethanol (E85)	1.293	0.001588	0.000967	0.000722	0.001519	0.001104	0.000554
^a depending on fuel							
^b at $\lambda = 2$, dry air, 273 K, 101.3 kPa							
^c u accurate within 0.2 % for mass composition of: C = 66 - 76 %; H = 22 - 25 %; N = 0 - 12 %							
^d NMHC on the basis of $\text{CH}_{2.93}$ (for total HC the u_{gas} coefficient of CH_4 shall be used)							
^e u accurate within 0.2 % for mass composition of: C3 = 70 - 90 %; C4 = 10 - 30 %							

Alternatively, the u values may be calculated using the exact calculation method generally described in paragraph 8.4.2.4., as follows:

$$u_{\text{gas}} = \frac{M_{\text{gas}}}{M_{\text{d}} \times \left(1 - \frac{1}{D}\right) + M_{\text{e}} \times \left(\frac{1}{D}\right)} \times \frac{1}{1000} \quad (57)$$

Where:

M_{gas} is the molar mass of the gas component, g/mol (see Appendix 5 to this annex)

M_{e} is the molar mass of the exhaust gas, g/mol

M_{d} is the molar mass of the diluent = 28.965 g/mol

D is the dilution factor (see paragraph 8.5.2.3.2.)

8.5.2.3.2. Determination of the background corrected concentrations

The average background concentration of the gaseous pollutants in the diluent shall be subtracted from the measured concentrations to get the net concentrations of the pollutants. The average values of the background

concentrations can be determined by the sample bag method or by continuous measurement with integration. The following equation shall be used:

$$c_{\text{gas}} = c_{\text{gas,e}} - c_d \times (1 - (1/D)) \quad (58)$$

Where:

$c_{\text{gas,e}}$ is the concentration of the component measured in the diluted exhaust gas, ppm

c_d is the concentration of the component measured in the diluent, ppm

D is the dilution factor

The dilution factor shall be calculated as follows:

- (a) For diesel fuelled engines and LPG fuelled gas engines

$$D = \frac{F_S}{c_{\text{CO}_2,\text{e}} + (c_{\text{HC,e}} + c_{\text{CO,e}}) \times 10^{-4}} \quad (59)$$

- (b) For natural gas fuelled gas engines

$$D = \frac{F_S}{c_{\text{CO}_2,\text{e}} + (c_{\text{NMHC,e}} + c_{\text{CO,e}}) \times 10^{-4}} \quad (60)$$

Where:

$c_{\text{CO}_2,\text{e}}$ is the wet concentration of CO₂ in the diluted exhaust gas, per cent vol

$c_{\text{HC,e}}$ is the wet concentration of HC in the diluted exhaust gas, ppm C1

$c_{\text{NMHC,e}}$ is the wet concentration of NMHC in the diluted exhaust gas, ppm C1

$c_{\text{CO,e}}$ is the wet concentration of CO in the diluted exhaust gas, ppm

F_S is the stoichiometric factor

The stoichiometric factor shall be calculated as follows:

$$F_S = 100 \times \frac{1}{1 + \frac{\alpha}{2} + 3,76 \times \left(1 + \frac{\alpha}{4}\right)} \quad (61)$$

Where:

α is the molar hydrogen ratio of the fuel (H/C)

Alternatively, if the fuel composition is not known, the following stoichiometric factors may be used:

$$F_S (\text{diesel}) = 13.4$$

$$F_S (\text{LPG}) = 11.6$$

$$F_S (\text{NG}) = 9.5$$

$$F_S (\text{E10}) = 13.3$$

$$F_S (\text{E85}) = 11.5$$

8.5.2.3.3. Systems with flow compensation

For systems without heat exchanger, the mass of the pollutants (g/test) shall be determined by calculating the instantaneous mass emissions and integrating the instantaneous values over the cycle. Also, the background correction shall

be applied directly to the instantaneous concentration value. The following equation shall be applied:

$$m_{\text{gas}} = \sum_{i=1}^n \left[(m_{\text{ed},i} \times c_{\text{gas},e} \times u_{\text{gas}}) \right] - \left[(m_{\text{ed}} \times c_d \times (1 - 1/D) \times u_{\text{gas}}) \right] \quad (62)$$

Where:

$c_{\text{gas},e}$ is the concentration of the component measured in the diluted exhaust gas, ppm

c_d is the concentration of the component measured in the diluent, ppm

$m_{\text{ed},i}$ is the instantaneous mass of the diluted exhaust gas, kg

m_{ed} is the total mass of diluted exhaust gas over the cycle, kg

u_{gas} is the tabulated value from Table 6

D is the dilution factor

8.5.3. Particulate determination

8.5.3.1. Calculation of mass emission

The particulate mass (g/test) shall be calculated after buoyancy correction of the particulate sample filter according to paragraph 8.3., as follows:

$$m_{\text{PM}} = \frac{m_p}{m_{\text{sep}}} \times \frac{m_{\text{ed}}}{1,000} \quad (63)$$

Where:

m_p is the particulate mass sampled over the cycle, mg

m_{sep} is the mass of diluted exhaust gas passing the particulate collection filters, kg

m_{ed} is the mass of diluted exhaust gas over the cycle, kg

With

$$m_{\text{sep}} = m_{\text{set}} - m_{\text{ssd}} \quad (64)$$

Where:

m_{set} is the mass of double diluted exhaust gas through particulate filter, kg

m_{ssd} is the mass of secondary diluent, kg

If the particulate background level of the diluent is determined in accordance with paragraph 7.5.6., the particulate mass may be background corrected. In this case, the particulate mass (g/test) shall be calculated as follows:

$$m_{\text{PM}} = \left[\frac{m_p}{m_{\text{sep}}} - \left(\frac{m_b}{m_{\text{sd}}} \times \left(1 - \frac{1}{D} \right) \right) \right] \times \frac{m_{\text{ed}}}{1,000} \quad (65)$$

Where:

m_{sep} is the mass of diluted exhaust gas passing the particulate collection filters, kg

m_{ed} is the mass of diluted exhaust gas over the cycle, kg

m_{sd} is the mass of diluent sampled by background particulate sampler, kg

m_b is the mass of the collected background particulates of the diluent, mg

D is the dilution factor as determined in paragraph 8.5.2.3.2.

8.6. General calculations

8.6.1. Drift correction

With respect to drift verification in paragraph 7.8.4., the corrected concentration value shall be calculated as follows:

$$c_{\text{cor}} = c_{\text{ref},z} + (c_{\text{ref},s} - c_{\text{ref},z}) \left(\frac{2 \cdot c_{\text{gas}} - (c_{\text{pre},z} + c_{\text{post},z})}{(c_{\text{pre},s} + c_{\text{post},s}) - (c_{\text{pre},z} + c_{\text{post},z})} \right) \quad (66)$$

Where:

$c_{\text{ref},z}$ is the reference concentration of the zero gas (usually zero), ppm

$c_{\text{ref},s}$ is the reference concentration of the span gas, ppm

$c_{\text{pre},z}$ is the pre-test analyzer concentration of the zero gas, ppm

$c_{\text{pre},s}$ is the pre-test analyzer concentration of the span gas, ppm

$c_{\text{post},z}$ is the post-test analyzer concentration of the zero gas, ppm

$c_{\text{post},s}$ is the post-test analyzer concentration of the span gas, ppm

c_{gas} is the sample gas concentration, ppm

Two sets of specific emission results shall be calculated for each component in accordance with paragraph 8.6.3., after any other corrections have been applied. One set shall be calculated using uncorrected concentrations and another set shall be calculated using the concentrations corrected for drift according to equation 66.

Depending on the measurement system and calculation method used, the uncorrected emissions results shall be calculated with equations 36, 37, 56, 58 or 62, respectively. For calculation of the corrected emissions, c_{gas} in equations 36, 37, 56, 58 or 62, respectively, shall be replaced with c_{cor} of equation 66. If instantaneous concentration values $c_{\text{gas},i}$ are used in the respective equation, the corrected value shall also be applied as instantaneous value $c_{\text{cor},i}$. In equations 58 and 62, the correction shall be applied to both the measured and the background concentration.

The comparison shall be made as a percentage of the uncorrected results. The difference between the uncorrected and the corrected brake-specific emission values shall be within ± 4 per cent of the uncorrected brake-specific emission values or within ± 4 per cent of the respective limit value, whichever is greater. If the drift is greater than 4 per cent, the test shall be voided.

If drift correction is applied, only the drift-corrected emission results shall be used when reporting emissions.

8.6.2. Calculation of NMHC and CH₄

The calculation of NMHC and CH₄ depends on the calibration method used. The FID for the measurement without NMC (lower path of Appendix 2 to this annex, Figure 11), shall be calibrated with propane. For the calibration of the FID in series with NMC (upper path of Appendix 2 to this annex, Figure 11), the following methods are permitted.

(a) Calibration gas – propane; propane bypasses NMC;

(b) Calibration gas – methane; methane passes through NMC.

The concentration of NMHC and CH₄ shall be calculated as follows for (a):

$$c_{\text{NMHC}} = \frac{c_{\text{HC}(w/NMC)} - c_{\text{HC}(w/oNMC)} \times (1 - E_E)}{r_h \times (E_E - E_M)} \quad (67)$$

$$c_{CH_4} = \frac{c_{HC(w/oNMC)} \times (1 - E_M) - c_{HC(w/NMC)}}{E_E - E_M} \quad (68)$$

The concentration of NMHC and CH₄ shall be calculated as follows for (b):

$$c_{NMHC} = \frac{c_{HC(w/oNMC)} \times (1 - E_M) - c_{HC(w/NMC)} \times r_h \times (1 - E_M)}{E_E - E_M} \quad (67a)$$

$$c_{CH_4} = \frac{c_{HC(w/NMC)} \times r_h \times (1 - E_M) - c_{HC(w/oNMC)} \times (1 - E_E)}{r_h \times (E_E - E_M)} \quad (68a)$$

Where:

$c_{HC(w/NMC)}$ is the HC concentration with sample gas flowing through the NMC, ppm

$c_{HC(w/oNMC)}$ is the HC concentration with sample gas bypassing the NMC, ppm

r_h is the methane response factor as determined per paragraph 9.3.7.2.

E_M is the methane efficiency as determined per paragraph 9.3.8.1.

E_E is the ethane efficiency as determined per paragraph 9.3.8.2.

If $r_h < 1.05$, it may be omitted in equations 67, 67a and 68a.

8.6.3. Calculation of the specific emissions

The specific emissions e_{gas} or e_{PM} (g/kWh) shall be calculated for each individual component in the following ways depending on the type of test cycle.

For the WHSC, hot WHTC, or cold WHTC, the following equation shall be applied:

$$e = \frac{m}{W_{act}} \quad (69)$$

$$e = \frac{(0,14 \times m_{cold}) + (0,86 \times m_{hot})}{(0,14 \times W_{act,cold}) + (0,86 \times W_{act,hot})} \quad (70)$$

Where:

m is the mass emission of the component, g/test

W_{act} is the actual cycle work as determined according to paragraph 7.8.6., kWh

For the WHTC, the final test result shall be a weighted average from cold start test and hot start test according to the following equation:

Where:

m_{cold} is the mass emission of the component on the cold start test, g/test

m_{hot} is the mass emission of the component on the hot start test, g/test

$W_{act,cold}$ is the actual cycle work on the cold start test, kWh

$W_{act,hot}$ is the actual cycle work on the hot start test, kWh

If periodic regeneration in accordance with paragraph 6.6.2. applies, the regeneration adjustment factors $k_{r,u}$ or $k_{r,d}$ shall be multiplied with or be added to, respectively, the specific emissions result e as determined in equations 69 and 70.

9. Equipment specification and verification

This annex does not contain details of flow, pressure, and temperature measuring equipment or systems. Instead, only the linearity requirements of such equipment or systems necessary for conducting an emissions test are given in paragraph 9.2.

9.1. Dynamometer specification

An engine dynamometer with adequate characteristics to perform the appropriate test cycle described in paragraphs 7.2.1. and 7.2.2. shall be used.

The instrumentation for torque and speed measurement shall allow the measurement accuracy of the shaft power as needed to comply with the cycle validation criteria. Additional calculations may be necessary. The accuracy of the measuring equipment shall be such that the linearity requirements given in paragraph 9.2., Table 7 are not exceeded.

9.2. Linearity requirements

The calibration of all measuring instruments and systems shall be traceable to national (international) standards. The measuring instruments and systems shall comply with the linearity requirements given in Table 7. The linearity verification according to paragraph 9.2.1. shall be performed for the gas analyzers at least every three months or whenever a system repair or change is made that could influence calibration. For the other instruments and systems, the linearity verification shall be done as required by internal audit procedures, by the instrument manufacturer or in accordance with ISO 9000 requirements.

Table 7

Linearity requirements of instruments and measurement systems

<i>Measurement system</i>	$ \chi_{min} \times (a_1 - 1) + a_0 $	<i>Slope</i> a_1	<i>Standard error</i> <i>SEE</i>	<i>Coefficient of</i> <i>determination</i> r^2
Engine speed	$\leq 0.05\% \text{ max}$	0.98 - 1.02	$\leq 2\% \text{ max}$	≥ 0.990
Engine torque	$\leq 1\% \text{ max}$	0.98 - 1.02	$\leq 2\% \text{ max}$	≥ 0.990
Fuel flow	$\leq 1\% \text{ max}$	0.98 - 1.02	$\leq 2\% \text{ max}$	≥ 0.990
Airflow	$\leq 1\% \text{ max}$	0.98 - 1.02	$\leq 2\% \text{ max}$	≥ 0.990
Exhaust gas flow	$\leq 1\% \text{ max}$	0.98 - 1.02	$\leq 2\% \text{ max}$	≥ 0.990
Diluent flow	$\leq 1\% \text{ max}$	0.98 - 1.02	$\leq 2\% \text{ max}$	≥ 0.990
Diluted exhaust gas flow	$\leq 1\% \text{ max}$	0.98 - 1.02	$\leq 2\% \text{ max}$	≥ 0.990
Sample flow	$\leq 1\% \text{ max}$	0.98 - 1.02	$\leq 2\% \text{ max}$	≥ 0.990
Gas analyzers	$\leq 0.5\% \text{ max}$	0.99 - 1.01	$\leq 1\% \text{ max}$	≥ 0.998
Gas dividers	$\leq 0.5\% \text{ max}$	0.98 - 1.02	$\leq 2\% \text{ max}$	≥ 0.990
Temperatures	$\leq 1\% \text{ max}$	0.99 - 1.01	$\leq 1\% \text{ max}$	≥ 0.998
Pressures	$\leq 1\% \text{ max}$	0.99 - 1.01	$\leq 1\% \text{ max}$	≥ 0.998
PM balance	$\leq 1\% \text{ max}$	0.99 - 1.01	$\leq 1\% \text{ max}$	≥ 0.998

9.2.1. Linearity verification

9.2.1.1. Introduction

A linearity verification shall be performed for each measurement system listed in Table 7. At least 10 reference values, or as specified otherwise, shall be introduced to the measurement system. For stand-alone pressure and temperature linearity verifications, at least three reference values shall be selected. The measured values shall be compared to the reference values by using a least squares linear regression in accordance with equation 11 in

paragraph 7.8.7. The maximum limits in Table 7 refer to the maximum values expected during testing.

9.2.1.2. General requirements

The measurement systems shall be warmed up according to the recommendations of the instrument manufacturer. The measurement systems shall be operated at their specified temperatures, pressures and flows.

9.2.1.3. Procedure

The linearity verification shall be run for each normally used operating range with the following steps:

- (a) The instrument shall be set at zero by introducing a zero signal. For gas analyzers, purified synthetic air (or nitrogen) shall be introduced directly to the analyzer port;
- (b) The instrument shall be spanned by introducing a span signal. For gas analyzers, an appropriate span gas shall be introduced directly to the analyzer port;
- (c) The zero procedure of (a) shall be repeated;
- (d) The verification shall be established by introducing at least 10 reference values (including zero) that are within the range from zero to the highest values expected during emission testing. For gas analyzers, known gas concentrations in accordance with paragraph 9.3.3.2. shall be introduced directly to the analyzer port;
- (e) At a recording frequency of at least 1 Hz, the reference values shall be measured and the measured values recorded for 30 seconds;
- (f) The arithmetic mean values over the 30 seconds period shall be used to calculate the least squares linear regression parameters according to equation 11 in paragraph 7.8.7.;
- (g) The linear regression parameters shall meet the requirements of paragraph 9.2., Table 7;
- (h) The zero setting shall be rechecked and the verification procedure repeated, if necessary.

9.3. Gaseous emissions measurement and sampling system

9.3.1. Analyzer specifications

9.3.1.1. General

The analyzers shall have a measuring range and response time appropriate for the accuracy required to measure the concentrations of the exhaust gas components under transient and steady state conditions.

The electromagnetic compatibility (EMC) of the equipment shall be on a level as to minimize additional errors.

9.3.1.2. Accuracy

The accuracy, defined as the deviation of the analyzer reading from the reference value, shall not exceed ± 2 per cent of the reading or ± 0.3 per cent of full scale whichever is larger.

9.3.1.3. Precision

The precision, defined as 2.5 times the standard deviation of 10 repetitive responses to a given calibration or span gas, shall be no greater than 1 per cent of full scale concentration for each range used above 155 ppm (or ppm C) or 2 per cent of each range used below 155 ppm (or ppm C).

9.3.1.4. Noise

- The analyzer peak-to-peak response to zero and calibration or span gases over any 10 seconds period shall not exceed 2 per cent of full scale on all ranges used.
- 9.3.1.5. Zero drift
- The drift of the zero response shall be specified by the instrument manufacturer.
- 9.3.1.6. Span drift
- The drift of the span response shall be specified by the instrument manufacturer.
- 9.3.1.7. Rise time
- The rise time of the analyzer installed in the measurement system shall not exceed 2.5 seconds.
- 9.3.1.8. Gas drying
- Exhaust gases may be measured wet or dry. A gas-drying device, if used, shall have a minimal effect on the composition of the measured gases. Chemical dryers are not an acceptable method of removing water from the sample.
- 9.3.2. Gas analyzers
- 9.3.2.1. Introduction
- Paragraphs 9.3.2.2. to 9.3.2.7. describe the measurement principles to be used. A detailed description of the measurement systems is given in Appendix 2 to this annex. The gases to be measured shall be analyzed with the following instruments. For non-linear analyzers, the use of linearizing circuits is permitted.
- 9.3.2.2. Carbon monoxide (CO) analysis
- The carbon monoxide analyzer shall be of the non-dispersive infrared (NDIR) absorption type.
- 9.3.2.3. Carbon dioxide (CO₂) analysis
- The carbon dioxide analyzer shall be of the non-dispersive infrared (NDIR) absorption type.
- 9.3.2.4. Hydrocarbon (HC) analysis
- The hydrocarbon analyzer shall be of the heated flame ionization detector (HFID) type with detector, valves, pipework, etc. heated so as to maintain a gas temperature of $463\text{ K} \pm 10\text{ K}$ ($190 \pm 10\text{ }^\circ\text{C}$). Optionally, for natural gas fuelled and PI engines, the hydrocarbon analyzer may be of the non-heated flame ionization detector (FID) type depending upon the method used (see Appendix 2 to this annex, paragraph A.2.1.3.).
- 9.3.2.5. Methane (CH₄) and non-methane hydrocarbon (NMHC) analysis
- The determination of the methane and non-methane hydrocarbon fraction shall be performed with a heated non-methane cutter (NMC) and two FIDs as per Appendix 2 to this annex, paragraph A.2.1.4. and paragraph A.2.1.5. The concentration of the components shall be determined as per paragraph 8.6.2.
- 9.3.2.6. Oxides of nitrogen (NO_x) analysis
- Two measurement instruments are specified for NO_x measurement and either instrument may be used provided it meets the criteria specified in paragraphs 9.3.2.6.1. or 9.3.2.6.2., respectively. For the determination of system equivalency of an alternate measurement procedure in accordance with paragraph 5.1.1., only the CLD is permitted.
- 9.3.2.6.1. Chemiluminescent detector (CLD)

If measured on a dry basis, the oxides of nitrogen analyzer shall be of the chemiluminescent detector (CLD) or heated chemiluminescent detector (HCLD) type with a NO₂/NO converter. If measured on a wet basis, a HCLD with converter maintained above 328 K (55 °C) shall be used, provided the water quench check (see paragraph 9.3.9.2.2.) is satisfied. For both CLD and HCLD, the sampling path shall be maintained at a wall temperature of 328 K to 473 K (55 °C to 200 °C) up to the converter for dry measurement and up to the analyzer for wet measurement.

9.3.2.6.2. Non-dispersive ultraviolet detector (NDUV)

A non-dispersive ultraviolet (NDUV) analyzer shall be used to measure NO_x concentration. If the NDUV analyzer measures only NO, a NO₂/NO converter shall be placed upstream of the NDUV analyzer. The NDUV temperature shall be maintained to prevent aqueous condensation, unless a sample dryer is installed upstream of the NO₂/NO converter, if used, or upstream of the analyzer.

9.3.2.7. Air to fuel measurement

The air to fuel measurement equipment used to determine the exhaust gas flow as specified in paragraph 8.4.1.6. shall be a wide range air to fuel ratio sensor or lambda sensor of Zirconia type. The sensor shall be mounted directly on the exhaust pipe where the exhaust gas temperature is high enough to eliminate water condensation.

The accuracy of the sensor with incorporated electronics shall be within:

±3 per cent of reading	for	$\lambda < 2$
±5 per cent of reading	for	$2 \leq \lambda < 5$
±10 per cent of reading	for	$5 \leq \lambda$

To fulfil the accuracy specified above, the sensor shall be calibrated as specified by the instrument manufacturer.

9.3.3. Gases

The shelf life of all gases shall be respected.

9.3.3.1. Pure gases

The required purity of the gases is defined by the contamination limits given below. The following gases shall be available for operation:

(a) For raw exhaust gas

Purified nitrogen

(Contamination ≤ 1 ppm C1, ≤ 1 ppm CO, ≤ 400 ppm CO₂, ≤ 0.1 ppm NO)

Purified oxygen

(Purity > 99.5 per cent vol O₂)

Hydrogen-helium mixture (FID burner fuel)

(40 \pm 1 per cent hydrogen, balance helium)

(Contamination ≤ 1 ppm C1, ≤ 400 ppm CO₂)

Purified synthetic air

(Contamination ≤ 1 ppm C1, ≤ 1 ppm CO, ≤ 400 ppm CO₂,

≤ 0.1 ppm NO)

(Oxygen content between 18-21 per cent vol.)

(b) For dilute exhaust gas (optionally for raw exhaust gas)

Purified nitrogen

(Contamination ≤ 0.05 ppm C1, ≤ 1 ppm CO, ≤ 10 ppm CO₂, ≤ 0.02 ppm NO)

Purified oxygen
(Purity > 99.5 per cent vol O₂)

Hydrogen-helium mixture (FID burner fuel)
(40 ± 1 per cent hydrogen, balance helium)
(Contamination ≤ 0.05 ppm C1, ≤ 10 ppm CO₂)

Purified synthetic air
(Contamination ≤ 0.05 ppm C1, ≤ 1 ppm CO, ≤ 10 ppm CO₂,
≤ 0.02 ppm NO)
(Oxygen content between 20.5 - 21.5 per cent vol.)

If gas bottles are not available, a gas purifier may be used, if contamination levels can be demonstrated.

9.3.3.2. Calibration and span gases

Mixtures of gases having the following chemical compositions shall be available, if applicable. Other gas combinations are allowed provided the gases do not react with one another. The expiration date of the calibration gases stated by the manufacturer shall be recorded.

C₃H₈ and purified synthetic air (see paragraph 9.3.3.1.);

CO and purified nitrogen;

NO and purified nitrogen;

NO₂ and purified synthetic air;

CO₂ and purified nitrogen;

CH₄ and purified synthetic air;

C₂H₆ and purified synthetic air.

The true concentration of a calibration and span gas shall be within ±1 per cent of the nominal value, and shall be traceable to national or international standards. All concentrations of calibration gas shall be given on a volume basis (volume per cent or volume ppm).

9.3.3.3. Gas dividers

The gases used for calibration and span may also be obtained by means of gas dividers (precision blending devices), diluting with purified N₂ or with purified synthetic air. The accuracy of the gas divider shall be such that the concentration of the blended calibration gases is accurate to within ±2 per cent. This accuracy implies that primary gases used for blending shall be known to an accuracy of at least ±1 per cent, traceable to national or international gas standards. The verification shall be performed at between 15 and 50 per cent of full scale for each calibration incorporating a gas divider. An additional verification may be performed using another calibration gas, if the first verification has failed.

Optionally, the blending device may be checked with an instrument which by nature is linear, e.g. using NO gas with a CLD. The span value of the instrument shall be adjusted with the span gas directly connected to the instrument. The gas divider shall be checked at the settings used and the nominal value shall be compared to the measured concentration of the instrument. This difference shall in each point be within ±1 per cent of the nominal value.

For conducting the linearity verification according to paragraph 9.2.1., the gas divider shall be accurate to within ±1 per cent.

9.3.3.4. Oxygen interference check gases

Oxygen interference check gases are a blend of propane, oxygen and nitrogen. They shall contain propane with 350 ppm C \pm 75 ppm C hydrocarbon. The concentration value shall be determined to calibration gas tolerances by chromatographic analysis of total hydrocarbons plus impurities or by dynamic blending. The oxygen concentrations required for positive ignition and compression ignition engine testing are listed in Table 8 with the remainder being purified nitrogen.

Table 8
Oxygen interference check gases

<i>Type of engine</i>	<i>O₂ concentration (per cent)</i>
Compression ignition	21 (20 to 22)
Compression and positive ignition	10 (9 to 11)
Compression and positive ignition	5 (4 to 6)
Positive ignition	0 (0 to 1)

9.3.4. Leak check

A system leak check shall be performed. The probe shall be disconnected from the exhaust system and the end plugged. The analyzer pump shall be switched on. After an initial stabilization period all flowmeters will read approximately zero in the absence of a leak. If not, the sampling lines shall be checked and the fault corrected.

The maximum allowable leakage rate on the vacuum side shall be 0.5 per cent of the in-use flow rate for the portion of the system being checked. The analyzer flows and bypass flows may be used to estimate the in-use flow rates.

Alternatively, the system may be evacuated to a pressure of at least 20 kPa vacuum (80 kPa absolute). After an initial stabilization period the pressure increase Δp (kPa/min) in the system shall not exceed:

$$\Delta p = p / V_s \times 0.005 \times q_{vs} \quad (71)$$

Where:

V_s is the system volume, l

q_{vs} is the system flow rate, l/min

Another method is the introduction of a concentration step change at the beginning of the sampling line by switching from zero to span gas. If for a correctly calibrated analyzer after an adequate period of time the reading is \leq 99 per cent compared to the introduced concentration, this points to a leakage problem that shall be corrected.

9.3.5. Response time check of the analytical system

The system settings for the response time evaluation shall be exactly the same as during measurement of the test run (i.e. pressure, flow rates, filter settings on the analyzers and all other response time influences). The response time determination shall be done with gas switching directly at the inlet of the sample probe. The gas switching shall be done in less than 0.1 second. The gases used for the test shall cause a concentration change of at least 60 per cent full scale (FS).

The concentration trace of each single gas component shall be recorded. The response time is defined to be the difference in time between the gas switching and the appropriate change of the recorded concentration. The system response time (t_{90}) consists of the delay time to the measuring detector and the rise time

of the detector. The delay time is defined as the time from the change (t_0) until the response is 10 per cent of the final reading (t_{10}). The rise time is defined as the time between 10 per cent and 90 per cent response of the final reading ($t_{90} - t_{10}$).

For time alignment of the analyzer and exhaust flow signals, the transformation time is defined as the time from the change (t_0) until the response is 50 per cent of the final reading (t_{50}).

The system response time shall be ≤ 10 s with a rise time of ≤ 2.5 seconds in accordance with paragraph 9.3.1.7. for all limited components (CO, NO_x, HC or NMHC) and all ranges used. When using a NMC for the measurement of NMHC, the system response time may exceed 10 seconds.

9.3.6. Efficiency test of NO_x converter

The efficiency of the converter used for the conversion of NO₂ into NO is tested as given in paragraphs 9.3.6.1. to 9.3.6.8. (see Figure 8).

Figure 8
Scheme of NO₂ converter efficiency device

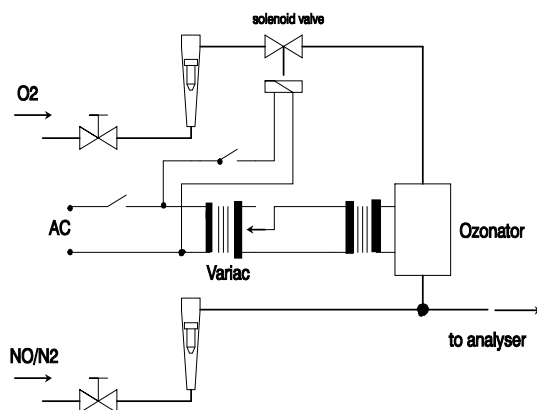

9.3.6.1. Test setup

Using the test setup as schematically shown in Figure 8 and the procedure below, the efficiency of the converter shall be tested by means of an ozonator.

9.3.6.2. Calibration

The CLD and the HCLD shall be calibrated in the most common operating range following the manufacturer's specifications using zero and span gas (the NO content of which shall amount to about 80 per cent of the operating range and the NO₂ concentration of the gas mixture to less than 5 per cent of the NO concentration). The NO_x analyzer shall be in the NO mode so that the span gas does not pass through the converter. The indicated concentration has to be recorded.

9.3.6.3. Calculation

The per cent efficiency of the converter shall be calculated as follows:

$$E_{\text{NO}_x} = \left(1 + \frac{a - b}{c - d} \right) \times 100 \quad (72)$$

Where:

- a is the NO_x concentration according to paragraph 9.3.6.6.
- b is the NO_x concentration according to paragraph 9.3.6.7.
- c is the NO concentration according to paragraph 9.3.6.4.

- d* is the NO concentration according to paragraph 9.3.6.5.
- 9.3.6.4. Adding of oxygen
Via a T-fitting, oxygen or zero air shall be added continuously to the gas flow until the concentration indicated is about 20 per cent less than the indicated calibration concentration given in paragraph 9.3.6.2. (the analyzer is in the NO mode).
The indicated concentration (*c*) shall be recorded. The ozonator is kept deactivated throughout the process.
- 9.3.6.5. Activation of the ozonator
The ozonator shall be activated to generate enough ozone to bring the NO concentration down to about 20 per cent (minimum 10 per cent) of the calibration concentration given in paragraph 9.3.6.2. The indicated concentration (*d*) shall be recorded (the analyzer is in the NO mode).
- 9.3.6.6. NO_x mode
The NO analyzer shall be switched to the NO_x mode so that the gas mixture (consisting of NO, NO₂, O₂ and N₂) now passes through the converter. The indicated concentration (*a*) shall be recorded (the analyzer is in the NO_x mode).
- 9.3.6.7. Deactivation of the ozonator
The ozonator is now deactivated. The mixture of gases described in paragraph 9.3.6.6. passes through the converter into the detector. The indicated concentration (*b*) shall be recorded (the analyzer is in the NO_x mode).
- 9.3.6.8. NO mode
Switched to NO mode with the ozonator deactivated, the flow of oxygen or synthetic air shall be shut off. The NO_x reading of the analyzer shall not deviate by more than ±5 per cent from the value measured according to paragraph 9.3.6.2. (the analyzer is in the NO mode).
- 9.3.6.9. Test interval
The efficiency of the converter shall be tested at least once per month.
- 9.3.6.10. Efficiency requirement
The efficiency of the converter E_{NO_x} shall not be less than 95 per cent.
If, with the analyzer in the most common range, the ozonator cannot give a reduction from 80 per cent to 20 per cent according to paragraph 9.3.6.5., the highest range which will give the reduction shall be used.
- 9.3.7. Adjustment of the FID
- 9.3.7.1. Optimization of the detector response
The FID shall be adjusted as specified by the instrument manufacturer. A propane in air span gas shall be used to optimize the response on the most common operating range.
With the fuel and airflow rates set at the manufacturer's recommendations, a 350 ± 75 ppm C span gas shall be introduced to the analyzer. The response at a given fuel flow shall be determined from the difference between the span gas response and the zero gas response. The fuel flow shall be incrementally adjusted above and below the manufacturer's specification. The span and zero response at these fuel flows shall be recorded. The difference between the span and zero response shall be plotted and the fuel flow adjusted to the rich side of the curve. This is the initial flow rate setting which may need further optimization depending on the results of the hydrocarbon response factors and the oxygen interference check according to paragraphs 9.3.7.2. and 9.3.7.3. If the oxygen interference or the hydrocarbon response factors do not meet the following

specifications, the airflow shall be incrementally adjusted above and below the manufacturer's specifications, repeating paragraphs 9.3.7.2. and 9.3.7.3. for each flow.

The optimization may optionally be conducted using the procedures outlined in SAE paper No. 770141.

9.3.7.2. Hydrocarbon response factors

A linearity verification of the analyzer shall be performed using propane in air and purified synthetic air according to paragraph 9.2.1.3.

Response factors shall be determined when introducing an analyzer into service and after major service intervals. The response factor (r_h) for a particular hydrocarbon species is the ratio of the FID C1 reading to the gas concentration in the cylinder expressed by ppm C1.

The concentration of the test gas shall be at a level to give a response of approximately 80 per cent of full scale. The concentration shall be known to an accuracy of ± 2 per cent in reference to a gravimetric standard expressed in volume. In addition, the gas cylinder shall be preconditioned for 24 hours at a temperature of $298 \text{ K} \pm 5 \text{ K}$ ($25 \text{ }^\circ\text{C} \pm 5 \text{ }^\circ\text{C}$).

The test gases to be used and the relative response factor ranges are as follows:

- (a) Methane and purified synthetic air $1.00 \leq r_h \leq 1.15$;
- (b) Propylene and purified synthetic air $0.90 \leq r_h \leq 1.1$;
- (c) Toluene and purified synthetic air $0.90 \leq r_h \leq 1.1$.

These values are relative to a r_h of 1 for propane and purified synthetic air.

9.3.7.3. Oxygen interference check

For raw exhaust gas analyzers only, the oxygen interference check shall be performed when introducing an analyzer into service and after major service intervals.

A measuring range shall be chosen where the oxygen interference check gases will fall in the upper 50 per cent. The test shall be conducted with the oven temperature set as required. Oxygen interference check gas specifications are found in paragraph 9.3.3.4.

- (a) The analyzer shall be set at zero;
- (b) The analyzer shall be spanned with the 0 per cent oxygen blend for positive ignition engines. Compression ignition engine instruments shall be spanned with the 21 per cent oxygen blend;
- (c) The zero response shall be rechecked. If it has changed by more than 0.5 per cent of full scale, steps (a) and (b) of this paragraph shall be repeated;
- (d) The 5 per cent and 10 per cent oxygen interference check gases shall be introduced;
- (e) The zero response shall be rechecked. If it has changed by more than ± 1 per cent of full scale, the test shall be repeated;
- (f) The oxygen interference E_{O_2} shall be calculated for each mixture in step (d) as follows:

$$E_{O_2} = (c_{\text{ref,d}} - c) \times 100 / c_{\text{ref,d}} \quad (73)$$

With the analyzer response being

$$c = \frac{c_{\text{ref,b}} \times c_{\text{FS,b}}}{c_{\text{m,b}}} \times \frac{c_{\text{m,d}}}{c_{\text{FS,d}}} \quad (74)$$

Where:

$c_{\text{ref,b}}$ is the reference HC concentration in step (b), ppm C

$c_{\text{ref,d}}$ is the reference HC concentration in step (d), ppm C

$c_{\text{FS,b}}$ is the full scale HC concentration in step (b), ppm C

$c_{\text{FS,d}}$ is the full scale HC concentration in step (d), ppm C

$c_{\text{m,b}}$ is the measured HC concentration in step (b), ppm C

$c_{\text{m,d}}$ is the measured HC concentration in step (d), ppm C

- (g) The oxygen interference E_{O_2} shall be less than ± 1.5 per cent for all required oxygen interference check gases prior to testing;
- (h) If the oxygen interference E_{O_2} is greater than ± 1.5 per cent, corrective action may be taken by incrementally adjusting the airflow above and below the manufacturer's specifications, the fuel flow and the sample flow;
- (i) The oxygen interference shall be repeated for each new setting.

9.3.8. Efficiency of the non-methane cutter (NMC)

The NMC is used for the removal of the non-methane hydrocarbons from the sample gas by oxidizing all hydrocarbons except methane. Ideally, the conversion for methane is 0 per cent, and for the other hydrocarbons represented by ethane is 100 per cent. For the accurate measurement of NMHC, the two efficiencies shall be determined and used for the calculation of the NMHC emission mass flow rate (see paragraph 8.6.2.).

9.3.8.1. Methane Efficiency

Methane calibration gas shall be flown through the FID with and without bypassing the NMC and the two concentrations recorded. The efficiency shall be determined as follows:

$$E_M = 1 - \frac{c_{\text{HC(w/NMC)}}}{c_{\text{HC(w/o NMC)}}} \quad (75)$$

Where:

$c_{\text{HC(w/NMC)}}$ is the HC concentration with CH_4 flowing through the NMC, ppm C

$c_{\text{HC(w/o NMC)}}$ is the HC concentration with CH_4 bypassing the NMC, ppm C

9.3.8.2. Ethane Efficiency

Ethane calibration gas shall be flown through the FID with and without bypassing the NMC and the two concentrations recorded. The efficiency shall be determined as follows:

$$E_E = 1 - \frac{c_{\text{HC(w/NMC)}}}{c_{\text{HC(w/o NMC)}}} \quad (76)$$

Where:

$c_{\text{HC(w/NMC)}}$ is the HC concentration with C_2H_6 flowing through the NMC, ppm C

$c_{\text{HC(w/o NMC)}}$ is the HC concentration with C_2H_6 bypassing the NMC, ppm C

9.3.9. Interference effects

Other gases than the one being analyzed can interfere with the reading in several ways. Positive interference occurs in NDIR instruments where the interfering gas gives the same effect as the gas being measured, but to a lesser degree. Negative interference occurs in NDIR instruments by the interfering gas broadening the absorption band of the measured gas, and in CLD instruments by the interfering gas quenching the reaction. The interference checks in paragraphs 9.3.9.1. and 9.3.9.3. shall be performed prior to an analyzer's initial use and after major service intervals.

9.3.9.1. CO analyzer interference check

Water and CO₂ can interfere with the CO analyzer performance. Therefore, a CO₂ span gas having a concentration of 80 to 100 per cent of full scale of the maximum operating range used during testing shall be bubbled through water at room temperature and the analyzer response recorded. The analyzer response shall not be more than 2 per cent of the mean CO concentration expected during testing.

Interference procedures for CO₂ and H₂O may also be run separately. If the CO₂ and H₂O levels used are higher than the maximum levels expected during testing, each observed interference value shall be scaled down by multiplying the observed interference by the ratio of the maximum expected concentration value to the actual value used during this procedure. Separate interference procedures concentrations of H₂O that are lower than the maximum levels expected during testing may be run, but the observed H₂O interference shall be scaled up by multiplying the observed interference by the ratio of the maximum expected H₂O concentration value to the actual value used during this procedure. The sum of the two scaled interference values shall meet the tolerance specified in this paragraph.

9.3.9.2. NO_x analyzer quench checks for CLD analyzer

The two gases of concern for CLD (and HCLD) analyzers are CO₂ and water vapour. Quench responses to these gases are proportional to their concentrations, and therefore require test techniques to determine the quench at the highest expected concentrations experienced during testing. If the CLD analyzer uses quench compensation algorithms that utilize H₂O and/or CO₂ measurement instruments, quench shall be evaluated with these instruments active and with the compensation algorithms applied.

9.3.9.2.1. CO₂ quench check

A CO₂ span gas having a concentration of 80 to 100 per cent of full scale of the maximum operating range shall be passed through the NDIR analyzer and the CO₂ value recorded as *A*. It shall then be diluted approximately 50 per cent with NO span gas and passed through the NDIR and CLD, with the CO₂ and NO values recorded as *B* and *C*, respectively. The CO₂ shall then be shut off and only the NO span gas be passed through the (H)CLD and the NO value recorded as *D*.

The per cent quench shall be calculated as follows:

$$E_{\text{CO}_2} = \left[1 - \left(\frac{C \times A}{(D \times A) - (D \times B)} \right) \right] \times 100 \quad (77)$$

Where:

A is the undiluted CO₂ concentration measured with NDIR, per cent

B is the diluted CO₂ concentration measured with NDIR, per cent

C is the diluted NO concentration measured with (H)CLD, ppm

D is the undiluted NO concentration measured with (H)CLD, ppm

Alternative methods of diluting and quantifying of CO₂ and NO span gas values such as dynamic mixing/blending are permitted with the approval of the Type Approval Authority.

9.3.9.2.2. Water quench check

This check applies to wet gas concentration measurements only. Calculation of water quench shall consider dilution of the NO span gas with water vapour and scaling of water vapour concentration of the mixture to that expected during testing.

A NO span gas having a concentration of 80 per cent to 100 per cent of full scale of the normal operating range shall be passed through the (H)CLD and the NO value recorded as *D*. The NO span gas shall then be bubbled through water at room temperature and passed through the (H)CLD and the NO value recorded as *C*. The water temperature shall be determined and recorded as *F*. The mixture's saturation vapour pressure that corresponds to the bubbler water temperature (*F*) shall be determined and recorded as *G*.

The water vapour concentration (in per cent) of the mixture shall be calculated as follows:

$$H = 100 \times (G / p_b) \quad (78)$$

and recorded as *H*. The expected diluted NO span gas (in water vapour) concentration shall be calculated as follows:

$$D_e = D \times (1 - H / 100) \quad (79)$$

and recorded as *D_e*. The maximum exhaust water vapour concentration (in per cent) expected during testing shall be estimated from the maximum CO₂ concentration in the exhaust gas *A* as follows:

$$H_m = a/2 \times A \quad (80)$$

and recorded as *H_m*

The per cent water quench shall be calculated as follows:

$$E_{H_2O} = 100 \times ((D_e - C) / D_e) \times (H_m / H) \quad (81)$$

Where:

D_e is the expected diluted NO concentration, ppm

C is the measured diluted NO concentration, ppm

H_m is the maximum water vapour concentration, per cent

H is the actual water vapour concentration, per cent

9.3.9.2.3. Maximum allowable quench

The combined CO₂ and water quench shall not exceed 2 per cent of full scale.

9.3.9.3. NO_x analyzer quench check for NDUV analyzer

Hydrocarbons and H₂O can positively interfere with a NDUV analyzer by causing a response similar to NO_x. If the NDUV analyzer uses compensation algorithms that utilize measurements of other gases to meet this interference verification, simultaneously such measurements shall be conducted to test the algorithms during the analyzer interference verification.

9.3.9.3.1. Procedure

The NDUV analyzer shall be started, operated, zeroed, and spanned according to the instrument manufacturer's instructions. It is recommended to extract engine exhaust to perform this verification. A CLD shall be used to quantify NO_x in the exhaust. The CLD response shall be used as the reference value. Also HC shall be measured in the exhaust with a FID analyzer. The FID response shall be used as the reference hydrocarbon value.

Upstream of any sample dryer, if used during testing, the engine exhaust shall be introduced into the NDUV analyzer. Time shall be allowed for the analyzer response to stabilize. Stabilization time may include time to purge the transfer line and to account for analyzer response. While all analyzers measure the sample's concentration, 30 seconds of sampled data shall be recorded, and the arithmetic means for the three analyzers calculated.

The CLD mean value shall be subtracted from the NDUV mean value. This difference shall be multiplied by the ratio of the expected mean HC concentration to the HC concentration measured during the verification, as follows:

$$E_{\text{HC/H}_2\text{O}} = (c_{\text{NO}_x,\text{CLD}} - c_{\text{NO}_x,\text{NDUV}}) \times \left(\frac{c_{\text{HC,e}}}{c_{\text{HC,m}}} \right) \quad (82)$$

Where:

$c_{\text{NO}_x,\text{CLD}}$ is the measured NO_x concentration with CLD, ppm

$c_{\text{NO}_x,\text{NDUV}}$ is the measured NO_x concentration with NDUV, ppm

$c_{\text{HC,e}}$ is the expected max. HC concentration, ppm

$c_{\text{HC,m}}$ is the measured HC concentration, ppm

9.3.9.3.2. Maximum allowable quench

The combined HC and water quench shall not exceed 2 per cent of the NO_x concentration expected during testing.

9.3.9.4. Sample dryer

A sample dryer removes water, which can otherwise interfere with a NO_x measurement.

9.3.9.4.1. Sample dryer efficiency

For dry CLD analysers, it shall be demonstrated that for the highest expected water vapour concentration H_m (see paragraph 9.3.9.2.2.), the sample dryer maintains CLD humidity at ≤ 5 g water/kg dry air (or about 0.8 volume per cent H₂O), which is 100 per cent relative humidity at 3.9 °C and 101.3 kPa. This humidity specification is also equivalent to about 25 per cent relative humidity at 25 °C and 101.3 kPa. This may be demonstrated by measuring the temperature at the outlet of a thermal dehumidifier, or by measuring humidity at a point just upstream of the CLD. Humidity of the CLD exhaust might also be measured as long as the only flow into the CLD is the flow from the dehumidifier.

9.3.9.4.2. Sample dryer NO₂ penetration

Liquid water remaining in an improperly designed sample dryer can remove NO₂ from the sample. If a sample dryer is used in combination with an NDUV analyzer without an NO₂/NO converter upstream, it could therefore remove NO₂ from the sample prior NO_x measurement.

The sample dryer shall allow for measuring at least 95 per cent of the total NO₂ at the maximum expected concentration of NO₂.

9.3.10. Sampling for raw gaseous emissions, if applicable

The gaseous emissions sampling probes shall be fitted at least 0.5 m or three times the diameter of the exhaust pipe - whichever is the larger - upstream of the exit of the exhaust gas system but sufficiently close to the engine as to ensure an exhaust gas temperature of at least 343 K (70 °C) at the probe.

In the case of a multi-cylinder engine with a branched exhaust manifold, the inlet of the probe shall be located sufficiently far downstream so as to ensure that the sample is representative of the average exhaust emissions from all cylinders. In multi-cylinder engines having distinct groups of manifolds, such as in a "Vee" engine configuration, it is recommended to combine the manifolds upstream of the sampling probe. If this is not practical, it is permissible to acquire a sample from the group with the highest CO₂ emission. For exhaust emission calculation the total exhaust mass flow shall be used.

If the engine is equipped with an exhaust after-treatment system, the exhaust sample shall be taken downstream of the exhaust after-treatment system.

9.3.11. Sampling for dilute gaseous emissions, if applicable

The exhaust pipe between the engine and the full flow dilution system shall conform to the requirements laid down in Appendix 2 to this annex. The gaseous emissions sample probe(s) shall be installed in the dilution tunnel at a point where the diluent and exhaust gas are well mixed, and in close proximity to the particulates sampling probe.

Sampling can generally be done in two ways:

- (a) The emissions are sampled into a sampling bag over the cycle and measured after completion of the test; for HC, the sample bag shall be heated to 464 ± 11 K (191 ± 11 °C), for NO_x, the sample bag temperature shall be above the dew point temperature;
- (b) The emissions are sampled continuously and integrated over the cycle.

The background concentration shall be determined upstream of the dilution tunnel according to (a) or (b), and shall be subtracted from the emissions concentration according to paragraph 8.5.2.3.2.

9.4. Particulate measurement and sampling system

9.4.1. General specifications

To determine the mass of the particulates, a particulate dilution and sampling system, a particulate sampling filter, a microgram balance, and a temperature and humidity controlled weighing chamber, are required. The particulate sampling system shall be designed to ensure a representative sample of the particulates proportional to the exhaust flow.

9.4.2. General requirements of the dilution system

The determination of the particulates requires dilution of the sample with filtered ambient air, synthetic air or nitrogen (the diluent). The dilution system shall be set as follows:

- (a) Completely eliminate water condensation in the dilution and sampling systems;
- (b) Maintain the temperature of the diluted exhaust gas between 315 K (42 °C) and 325 K (52 °C) within 20 cm upstream or downstream of the filter holder(s);
- (c) The diluent temperature shall be between 293 K and 325 K (20 °C to 52 °C) in close proximity to the entrance into the dilution tunnel;
- (d) The minimum dilution ratio shall be within the range of 5:1 to 7:1 and at least 2:1 for the primary dilution stage based on the maximum engine exhaust flow rate;

- (e) For a partial flow dilution system, the residence time in the system from the point of diluent introduction to the filter holder(s) shall be between 0.5 and 5 seconds;
- (f) For a full flow dilution system, the overall residence time in the system from the point of diluent introduction to the filter holder(s) shall be between 1 and 5 seconds, and the residence time in the secondary dilution system, if used, from the point of secondary diluent introduction to the filter holder(s) shall be at least 0.5 seconds.

Dehumidifying the diluent before entering the dilution system is permitted, and especially useful if diluent humidity is high.

9.4.3. Particulate sampling

9.4.3.1. Partial flow dilution system

The particulate sampling probe shall be installed in close proximity to the gaseous emissions sampling probe, but sufficiently distant as to not cause interference. Therefore, the installation provisions of paragraph 9.3.10. also apply to particulate sampling. The sampling line shall conform to the requirements laid down in Appendix 2 to this annex.

In the case of a multi-cylinder engine with a branched exhaust manifold, the inlet of the probe shall be located sufficiently far downstream so as to ensure that the sample is representative of the average exhaust emissions from all cylinders. In multi-cylinder engines having distinct groups of manifolds, such as in a "Vee" engine configuration, it is recommended to combine the manifolds upstream of the sampling probe. If this is not practical, it is permissible to acquire a sample from the group with the highest particulate emission. For exhaust emission calculation the total exhaust mass flow of the manifold shall be used.

9.4.3.2. Full flow dilution system

The particulate sampling probe shall be installed in close proximity to the gaseous emissions sampling probe, but sufficiently distant as to not cause interference, in the dilution tunnel. Therefore, the installation provisions of paragraph 9.3.11. also apply to particulate sampling. The sampling line shall conform to the requirements laid down in Appendix 2 to this annex.

9.4.4. Particulate sampling filters

The diluted exhaust shall be sampled by a filter that meets the requirements of paragraphs 9.4.4.1. to 9.4.4.3. during the test sequence.

9.4.4.1. Filter specification

All filter types shall have a 0.3 µm DOP (di-octylphthalate) or PAO (poly-alpha-olefin) collection efficiency of at least 99 per cent. The sample filter manufacturer's measurements reflected in their product ratings may be used to show this requirement. The filter material shall be either:

- (a) Fluorocarbon (PTFE) coated glass fibre, or
- (b) Fluorocarbon (PTFE) membrane.

9.4.4.2. Filter size

The filter shall be circular with a nominal diameter of 47 mm (tolerance of 46.50 ± 0.6 mm) and an exposed diameter (filter stain diameter) of at least 38 mm.

9.4.4.3. Filter face velocity

The face velocity through the filter shall be between 0.90 and 1.00 m/s with less than 5 per cent of the recorded flow values exceeding this range. If the total PM mass on the filter exceeds 400 µg, the filter face velocity may be

reduced to 0.50 m/s. The face velocity shall be calculated as the volumetric flow rate of the sample at the pressure upstream of the filter and temperature of the filter face, divided by the filter's exposed area.

9.4.5. Weighing chamber and analytical balance specifications

The chamber (or room) environment shall be free of any ambient contaminants (such as dust, aerosol, or semi-volatile material) that could contaminate the particulate filters. The weighing room shall meet the required specifications for at least 60 min before weighing filters.

9.4.5.1. Weighing chamber conditions

The temperature of the chamber (or room) in which the particulate filters are conditioned and weighed shall be maintained to within $295\text{ K} \pm 1\text{ K}$ ($22\text{ °C} \pm 1\text{ °C}$) during all filter conditioning and weighing. The humidity shall be maintained to a dew point of $282.5\text{ K} \pm 1\text{ K}$ ($9.5\text{ °C} \pm 1\text{ °C}$).

If the stabilization and weighing environments are separate, the temperature of the stabilization environment shall be maintained at a tolerance of $295\text{ K} \pm 3\text{ K}$ ($22\text{ °C} \pm 3\text{ °C}$), but the dew point requirement remains at $282.5\text{ K} \pm 1\text{ K}$ ($9.5\text{ °C} \pm 1\text{ °C}$).

Humidity and ambient temperature shall be recorded.

9.4.5.2. Reference filter weighing

At least two unused reference filters shall be weighed within 12 hours of, but preferably at the same time as the sample filter weighing. They shall be the same material as the sample filters. Buoyancy correction shall be applied to the weighings.

If the weight of any of the reference filters changes between sample filter weighings by more than $10\text{ }\mu\text{g}$, all sample filters shall be discarded and the emissions test repeated.

The reference filters shall be periodically replaced based on good engineering judgement, but at least once per year.

9.4.5.3. Analytical balance

The analytical balance used to determine the filter weight shall meet the linearity verification criterion of paragraph 9.2., Table 7. This implies a precision (standard deviation) of at least $2\text{ }\mu\text{g}$ and a resolution of at least $1\text{ }\mu\text{g}$ (1 digit = $1\text{ }\mu\text{g}$).

In order to ensure accurate filter weighing, it is recommended that the balance be installed as follows:

- (a) Installed on a vibration-isolation platform to isolate it from external noise and vibration;
- (b) Shielded from convective airflow with a static-dissipating draft shield that is electrically grounded.

9.4.5.4. Elimination of static electricity effects

The filter shall be neutralized prior to weighing, e.g. by a Polonium neutralizer or a device of similar effect. If a PTFE membrane filter is used, the static electricity shall be measured and is recommended to be within $\pm 2.0\text{ V}$ of neutral.

Static electric charge shall be minimized in the balance environment. Possible methods are as follows:

- (a) The balance shall be electrically grounded;
- (b) Stainless steel tweezers shall be used if PM samples are handled manually;

- (c) Tweezers shall be grounded with a grounding strap, or a grounding strap shall be provided for the operator such that the grounding strap shares a common ground with the balance. Grounding straps shall have an appropriate resistor to protect operators from accidental shock.

9.4.5.5. Additional specifications

All parts of the dilution system and the sampling system from the exhaust pipe up to the filter holder, which are in contact with raw and diluted exhaust gas, shall be designed to minimize deposition or alteration of the particulates. All parts shall be made of electrically conductive materials that do not react with exhaust gas components, and shall be electrically grounded to prevent electrostatic effects.

9.4.5.6. Calibration of the flow measurement instrumentation

Each flowmeter used in a particulate sampling and partial flow dilution system shall be subjected to the linearity verification, as described in paragraph 9.2.1., as often as necessary to fulfil the accuracy requirements of this Regulation. For the flow reference values, an accurate flowmeter traceable to international and/or national standards shall be used. For differential flow measurement calibration see paragraph 9.4.6.2.

9.4.6. Special requirements for the partial flow dilution system

The partial flow dilution system has to be designed to extract a proportional raw exhaust sample from the engine exhaust stream, thus responding to excursions in the exhaust stream flow rate. For this it is essential that the dilution ratio or the sampling ratio r_d or r_s be determined such that the accuracy requirements of paragraph 9.4.6.2. are fulfilled.

9.4.6.1. System response time

For the control of a partial flow dilution system, a fast system response is required. The transformation time for the system shall be determined by the procedure in paragraph 9.4.6.6. If the combined transformation time of the exhaust flow measurement (see paragraph 8.4.1.2.) and the partial flow system is ≤ 0.3 second, online control shall be used. If the transformation time exceeds 0.3 second, look ahead control based on a pre-recorded test run shall be used. In this case, the combined rise time shall be ≤ 1 second and the combined delay time ≤ 10 seconds.

The total system response shall be designed as to ensure a representative sample of the particulates, $q_{mp,i}$, proportional to the exhaust mass flow. To determine the proportionality, a regression analysis of $q_{mp,i}$ versus $q_{mew,i}$ shall be conducted on a minimum 5 Hz data acquisition rate, and the following criteria shall be met:

- (a) The coefficient of determination r^2 of the linear regression between $q_{mp,i}$ and $q_{mew,i}$ shall not be less than 0.95;
- (b) The standard error of estimate of $q_{mp,i}$ on $q_{mew,i}$ shall not exceed 5 per cent of q_{mp} maximum;
- (c) q_{mp} intercept of the regression line shall not exceed ± 2 per cent of q_{mp} maximum.

Look-ahead control is required if the combined transformation times of the particulate system, $t_{50,P}$ and of the exhaust mass flow signal, $t_{50,F}$ are > 0.3 second. In this case, a pre-test shall be run, and the exhaust mass flow signal of the pre-test be used for controlling the sample flow into the particulate system. A correct control of the partial dilution system is obtained, if the time trace of $q_{mew,pre}$ of the pre-test, which controls q_{mp} , is shifted by a "look-ahead" time of $t_{50,P} + t_{50,F}$.

For establishing the correlation between $q_{mp,i}$ and $q_{mew,i}$ the data taken during the actual test shall be used, with $q_{mew,i}$ time aligned by $t_{50,F}$ relative to $q_{mp,i}$ (no contribution from $t_{50,P}$ to the time alignment). That is, the time shift between q_{mew} and q_{mp} is the difference in their transformation times that were determined in paragraph 9.4.6.6.

9.4.6.2. Specifications for differential flow measurement

For partial flow dilution systems, the accuracy of the sample flow q_{mp} is of special concern, if not measured directly, but determined by differential flow measurement:

$$q_{mp} = q_{mdew} - q_{mdw} \quad (83)$$

In this case, the maximum error of the difference shall be such that the accuracy of q_{mp} is within ± 5 per cent when the dilution ratio is less than 15. It can be calculated by taking root-mean-square of the errors of each instrument.

Acceptable accuracies of q_{mp} can be obtained by either of the following methods:

- (a) The absolute accuracies of q_{mdew} and q_{mdw} are ± 0.2 per cent which guarantees an accuracy of q_{mp} of ≤ 5 per cent at a dilution ratio of 15. However, greater errors will occur at higher dilution ratios;
- (b) Calibration of q_{mdw} relative to q_{mdew} is carried out such that the same accuracies for q_{mp} as in (a) are obtained. For details see paragraph 9.4.6.3.;
- (c) The accuracy of q_{mp} is determined indirectly from the accuracy of the dilution ratio as determined by a tracer gas, e.g. CO₂. Accuracies equivalent to method (a) for q_{mp} are required;
- (d) The absolute accuracy of q_{mdew} and q_{mdw} is within ± 2 per cent of full scale, the maximum error of the difference between q_{mdew} and q_{mdw} is within 0.2 per cent, and the linearity error is within ± 0.2 per cent of the highest q_{mdew} observed during the test.

9.4.6.3. Calibration of differential flow measurement

The flowmeter or the flow measurement instrumentation shall be calibrated in one of the following procedures, such that the probe flow q_{mp} into the tunnel shall fulfil the accuracy requirements of paragraph 9.4.6.2.:

- (a) The flowmeter for q_{mdw} shall be connected in series to the flowmeter for q_{mdew} , the difference between the two flowmeters shall be calibrated for at least five set points with flow values equally spaced between the lowest q_{mdw} value used during the test and the value of q_{mdew} used during the test. The dilution tunnel may be bypassed;
- (b) A calibrated flow device shall be connected in series to the flowmeter for q_{mdew} and the accuracy shall be checked for the value used for the test. The calibrated flow device shall be connected in series to the flowmeter for q_{mdw} , and the accuracy shall be checked for at least five settings corresponding to dilution ratio between 3 and 50, relative to q_{mdew} used during the test;
- (c) The transfer tube (TT) shall be disconnected from the exhaust, and a calibrated flow-measuring device with a suitable range to measure q_{mp} shall be connected to the transfer tube. q_{mdew} shall be set to the value used during the test, and q_{mdw} shall be sequentially set to at least five values corresponding to dilution ratios between 3 and 50. Alternatively, a special calibration flow path may be provided, in which the tunnel is bypassed, but the total and diluent flow through the corresponding meters as in the actual test;

- (d) A tracer gas shall be fed into the exhaust transfer tube TT. This tracer gas may be a component of the exhaust gas, like CO₂ or NO_x. After dilution in the tunnel the tracer gas component shall be measured. This shall be carried out for five dilution ratios between 3 and 50. The accuracy of the sample flow shall be determined from the dilution ratio r_d :

$$q_{mp} = q_{mdew} / r_d \quad (84)$$

The accuracies of the gas analyzers shall be taken into account to guarantee the accuracy of q_{mp} .

9.4.6.4. Carbon flow check

A carbon flow check using actual exhaust is strongly recommended for detecting measurement and control problems and verifying the proper operation of the partial flow system. The carbon flow check should be run at least each time a new engine is installed, or something significant is changed in the test cell configuration.

The engine shall be operated at peak torque load and speed or any other steady state mode that produces 5 per cent or more of CO₂. The partial flow sampling system shall be operated with a dilution factor of about 15 to 1.

If a carbon flow check is conducted, the procedure given in Appendix 4 shall be applied. The carbon flow rates shall be calculated according to equations 112 to 114 in Appendix 4 to this annex. All carbon flow rates should agree to within 3 per cent.

9.4.6.5. Pre-test check

A pre-test check shall be performed within 2 hours before the test run in the following way.

The accuracy of the flowmeters shall be checked by the same method as used for calibration (see paragraph 9.4.6.2.) for at least two points, including flow values of q_{mdw} that correspond to dilution ratios between 5 and 15 for the q_{mdew} value used during the test.

If it can be demonstrated by records of the calibration procedure under paragraph 9.4.6.2. that the flowmeter calibration is stable over a longer period of time, the pre-test check may be omitted.

9.4.6.6. Determination of the transformation time

The system settings for the transformation time evaluation shall be exactly the same as during measurement of the test run. The transformation time shall be determined by the following method.

An independent reference flowmeter with a measurement range appropriate for the probe flow shall be put in series with and closely coupled to the probe. This flowmeter shall have a transformation time of less than 100 ms for the flow step size used in the response time measurement, with flow restriction sufficiently low as to not affect the dynamic performance of the partial flow dilution system, and consistent with good engineering practice.

A step change shall be introduced to the exhaust flow (or airflow if exhaust flow is calculated) input of the partial flow dilution system, from a low flow to at least 90 per cent of maximum exhaust flow. The trigger for the step change shall be the same one used to start the look-ahead control in actual testing. The exhaust flow step stimulus and the flowmeter response shall be recorded at a sample rate of at least 10 Hz.

From this data, the transformation time shall be determined for the partial flow dilution system, which is the time from the initiation of the step stimulus to the 50 per cent point of the flowmeter response. In a similar manner, the transformation times of the q_{mp} signal of the partial flow dilution system and

of the $q_{mew,i}$ signal of the exhaust flowmeter shall be determined. These signals are used in the regression checks performed after each test (see paragraph 9.4.6.1.).

The calculation shall be repeated for at least 5 rise and fall stimuli, and the results shall be averaged. The internal transformation time (< 100 ms) of the reference flowmeter shall be subtracted from this value. This is the "look-ahead" value of the partial flow dilution system, which shall be applied in accordance with paragraph 9.4.6.1.

9.5. Calibration of the CVS system

9.5.1. General

The CVS system shall be calibrated by using an accurate flowmeter and a restricting device. The flow through the system shall be measured at different restriction settings, and the control parameters of the system shall be measured and related to the flow.

Various types of flowmeters may be used, e.g. calibrated venturi, calibrated laminar flowmeter, calibrated turbine meter.

9.5.2. Calibration of the positive displacement pump (PDP)

All the parameters related to the pump shall be simultaneously measured along with the parameters related to a calibration venturi which is connected in series with the pump. The calculated flow rate (in m^3/s at pump inlet, absolute pressure and temperature) shall be plotted versus a correlation function which is the value of a specific combination of pump parameters. The linear equation which relates the pump flow and the correlation function shall be determined. If a CVS has a multiple speed drive, the calibration shall be performed for each range used.

Temperature stability shall be maintained during calibration.

Leaks in all the connections and ducting between the calibration venturi and the CVS pump shall be maintained lower than 0.3 per cent of the lowest flow point (highest restriction and lowest PDP speed point).

9.5.2.1. Data analysis

The airflow rate ($q_{v, CVS}$) at each restriction setting (minimum six settings) shall be calculated in standard m^3/s from the flowmeter data using the manufacturer's prescribed method. The airflow rate shall then be converted to pump flow (V_0) in m^3/rev at absolute pump inlet temperature and pressure as follows:

$$V_0 = \frac{q_{v, CVS}}{n} \times \frac{T}{273} \times \frac{101,3}{p_p} \quad (85)$$

Where:

$q_{v, CVS}$ is the airflow rate at standard conditions (101.3 kPa, 273 K), m^3/s

T is the temperature at pump inlet, K

p_p is the absolute pressure at pump inlet, kPa

n is the pump speed, rev/s

To account for the interaction of pressure variations at the pump and the pump slip rate, the correlation function (X_0) between pump speed, pressure differential from pump inlet to pump outlet and absolute pump outlet pressure shall be calculated as follows:

$$X_0 = \frac{1}{n} \times \sqrt{\frac{\Delta p_p}{p_p}} \quad (86)$$

Where:

Δp_p is the pressure differential from pump inlet to pump outlet, kPa

p_p is the absolute outlet pressure at pump outlet, kPa

A linear least-square fit shall be performed to generate the calibration equation as follows:

$$V_0 = D_0 - m \times X_0 \quad (87)$$

D_0 and m are the intercept and slope, respectively, describing the regression lines.

For a CVS system with multiple speeds, the calibration curves generated for the different pump flow ranges shall be approximately parallel, and the intercept values (D_0) shall increase as the pump flow range decreases.

The calculated values from the equation shall be within ± 0.5 per cent of the measured value of V_0 . Values of m will vary from one pump to another. Particulate influx over time will cause the pump slip to decrease, as reflected by lower values for m . Therefore, calibration shall be performed at pump start-up, after major maintenance, and if the total system verification indicates a change of the slip rate.

9.5.3. Calibration of the critical flow venturi (CFV)

Calibration of the CFV is based upon the flow equation for a critical venturi. Gas flow is a function of venturi inlet pressure and temperature.

To determine the range of critical flow, K_v shall be plotted as a function of venturi inlet pressure. For critical (choked) flow, K_v will have a relatively constant value. As pressure decreases (vacuum increases), the venturi becomes unchoked and K_v decreases, which indicates that the CFV is operated outside the permissible range.

9.5.3.1. Data analysis

The airflow rate ($q_{v, CVS}$) at each restriction setting (minimum 8 settings) shall be calculated in standard m^3/s from the flowmeter data using the manufacturer's prescribed method. The calibration coefficient shall be calculated from the calibration data for each setting as follows:

$$K_v = \frac{q_{v, CVS} \times \sqrt{T}}{p_p} \quad (88)$$

Where:

$q_{v, CVS}$ is the airflow rate at standard conditions (101.3 kPa, 273 K), m^3/s

T is the temperature at the venturi inlet, K

p_p is the absolute pressure at venturi inlet, kPa

The average K_v and the standard deviation shall be calculated. The standard deviation shall not exceed ± 0.3 per cent of the average K_v .

9.5.4. Calibration of the subsonic venturi (SSV)

Calibration of the SSV is based upon the flow equation for a subsonic venturi. Gas flow is a function of inlet pressure and temperature, pressure drop between the SSV inlet and throat, as shown in equation 53 (see paragraph 8.5.1.4.).

9.5.4.1. Data analysis

The airflow rate (Q_{SSV}) at each restriction setting (minimum 16 settings) shall be calculated in standard m^3/s from the flowmeter data using the manufacturer's prescribed method. The discharge coefficient shall be calculated from the calibration data for each setting as follows:

$$C_d = \frac{Q_{SSV}}{\frac{A_0}{60} \times d_v^2 \times p_p \times \sqrt{\left[\frac{1}{T} \times (r_p^{1.4286} - r_p^{1.7143}) \times \left(\frac{1}{1 - r_D^4 \times r_p^{1.4286}} \right) \right]}} \quad (89)$$

Where:

Q_{SSV} is the *airflow* rate at standard conditions (101.3 kPa, 273 K), m^3/s

T is the temperature at the venturi inlet, K

d_v is the diameter of the SSV throat, mm

r_p is the ratio of *the* SSV throat to inlet absolute static pressure = $1 - \frac{\Delta p}{p_p}$

r_D is the ratio of *the* SSV throat diameter, d_v , to the inlet pipe inner diameter D

To determine the range of subsonic flow, C_d shall be plotted as a function of Reynolds number Re , at the SSV throat. The Re at the SSV throat shall be calculated with the following equation:

$$Re = A_1 \times 60 \times \frac{Q_{SSV}}{d_v \times \mu} \quad (90)$$

With

$$\mu = \frac{b \times T^{1.5}}{S + T} \quad (91)$$

Where:

A_1 is 27.43831 in SI units of $\left(\frac{kg}{m^3}\right) \left(\frac{min}{s}\right) \left(\frac{mm}{m}\right)$

Q_{SSV} is the *airflow rate* at standard conditions (101.3 kPa, 273 K), m^3/s

d_v is the *diameter* of the SSV throat, mm

μ is the *absolute* or dynamic viscosity of the gas, kg/ms

b is 1.458×10^6 (*empirical constant*), $kg/ms K^{0.5}$

S is 110.4 (*empirical constant*), K

Because Q_{SSV} is an input to the Re equation, the calculations shall be started with an initial guess for Q_{SSV} or C_d of the calibration venturi, and repeated until Q_{SSV} converges. The convergence method shall be accurate to 0.1 per cent of point or better.

For a minimum of sixteen points in the region of subsonic flow, the calculated values of C_d from the resulting calibration curve fit equation shall be within ± 0.5 per cent of the measured C_d for each calibration point.

9.5.5. Total system verification

The total accuracy of the CVS sampling system and analytical system shall be determined by introducing a known mass of a pollutant gas into the system

while it is being operated in the normal manner. The pollutant is analysed, and the mass calculated according to paragraph 8.5.2.3. except in the case of propane where a u factor of 0.000507 is used in place of 0.000483 for HC. Either of the following two techniques shall be used.

9.5.5.1. Metering with a critical flow orifice

A known quantity of pure gas (carbon monoxide or propane) shall be fed into the CVS system through a calibrated critical orifice. If the inlet pressure is high enough, the flow rate, which is adjusted by means of the critical flow orifice, is independent of the orifice outlet pressure (critical flow). The CVS system shall be operated as in a normal exhaust emission test for about 5 to 10 minutes. A gas sample shall be analyzed with the usual equipment (sampling bag or integrating method), and the mass of the gas calculated.

The mass so determined shall be within ± 3 per cent of the known mass of the gas injected.

9.5.5.2. Metering by means of a gravimetric technique

The mass of a small cylinder filled with carbon monoxide or propane shall be determined with a precision of ± 0.01 g. For about 5 to 10 minutes, the CVS system shall be operated as in a normal exhaust emission test, while carbon monoxide or propane is injected into the system. The quantity of pure gas discharged shall be determined by means of differential weighing. A gas sample shall be analyzed with the usual equipment (sampling bag or integrating method), and the mass of the gas calculated.

The mass so determined shall be within ± 3 per cent of the known mass of the gas injected.

10. Particle number measurement test procedure

10.1. Sampling

Particle number emissions shall be measured by continuous sampling from 1) the tailpipe using fixed dilution 2) a proportional partial flow dilution system, as described in Appendix 2 to this annex, paragraph A.2.2.1. and A.2.2.2. or 3) a full flow dilution system as described in Appendix 2 to this annex, paragraph A.2.2.3. and A.2.2.4.

10.1.1. Diluent filtration

Diluent used for both the primary and, where applicable, secondary dilution of the exhaust in the dilution system shall be passed through filters meeting the High-Efficiency Particulate Air (HEPA) filter requirements defined in Appendix 2 to this annex, paragraphs A.2.2.2. or A.2.2.4. The diluent may optionally be charcoal scrubbed before being passed to the HEPA filter to reduce and stabilize the hydrocarbon concentrations in the diluent. It is recommended that an additional coarse particle filter is situated before the HEPA filter and after the charcoal scrubber, if used.

10.2. Compensating for particle number sample flow – full flow dilution systems

To compensate for the mass flow extracted from the dilution system for particle number sampling the extracted mass flow (filtered) shall be returned to the dilution system. Alternatively, the total mass flow in the dilution system may be mathematically corrected for the particle number sample flow extracted. Where the total mass flow extracted from the dilution system for the sum of particle number sampling and particulate mass sampling is less than 0.5 per cent of the total dilute exhaust gas flow in the dilution tunnel (m_{ed}) this correction, or flow return, may be neglected.

10.3. Compensating for particle number sample flow – partial flow dilution systems

10.3.1. For partial flow dilution systems the mass flow extracted from the dilution system for particle number sampling shall be accounted for in controlling the

proportionality of sampling. This shall be achieved either by feeding the particle number sample flow back into the dilution system upstream of the flow measuring device or by mathematical correction as outlined in paragraph 10.3.2. In the case of total sampling type partial flow dilution systems, the mass flow extracted for particle number sampling shall also be corrected for in the particulate mass calculation as outlined in paragraph 10.3.3.

10.3.2. The instantaneous exhaust gas flow rate into the dilution system (q_{mp}), used for controlling the proportionality of sampling, shall be corrected according to one of the following methods:

- (a) In the case where the extracted particle number sample flow is discarded, equation 83 in paragraph 9.4.6.2. shall be replaced by the following:

$$q_{mp} = q_{mdew} - q_{mdw} + q_{ex} \quad (92)$$

Where:

q_{mp} = sample flow of exhaust gas into partial flow dilution system, kg/s,

q_{mdew} = diluted exhaust mass flow rate, kg/s,

q_{mdw} = dilution air mass flow rate, kg/s,

q_{ex} = particle number sample mass flow rate, kg/s.

The q_{ex} signal sent to the partial flow system controller shall be accurate to within 0.1 per cent of q_{mdew} at all times and should be sent with frequency of at least 1 Hz.

- (b) In the case where the extracted particle number sample flow is fully or partially discarded, but an equivalent flow is fed back to the dilution system upstream of the flow measurement device, equation 83 in paragraph 9.4.6.2. shall be replaced by the following:

$$q_{mp} = q_{mdew} - q_{mdw} + q_{ex} - q_{sw} \quad (93)$$

Where:

q_{mp} = sample flow of exhaust gas into partial flow dilution system, kg/s,

q_{mdew} = diluted exhaust mass flow rate, kg/s,

q_{mdw} = dilution air mass flow rate, kg/s,

q_{ex} = particle number sample mass flow rate, kg/s,

q_{sw} = mass flow rate fed back into dilution tunnel to compensate for particle number sample extraction, kg/s.

The difference between q_{ex} and q_{sw} sent to the partial flow system controller shall be accurate to within 0.1 per cent of q_{mdew} at all times. The signal (or signals) should be sent with frequency of at least 1 Hz.

10.3.3. Correction of PM measurement

When a particle number sample flow is extracted from a total sampling partial flow dilution system, the mass of particulates (m_{PM}) calculated in paragraph 8.4.3.2.1. or 8.4.3.2.2. shall be corrected as follows to account for the flow extracted. This correction is required even where filtered extracted flow is fed back into the partial flow dilution systems.

$$m_{PM,corr} = m_{PM} \times \frac{m_{sed}}{(m_{sed} - m_{ex})} \quad (94)$$

Where:

$m_{PM,corr}$ = mass of particulates corrected for extraction of particle number sample flow, g/test,

m_{PM} = mass of particulates determined according to paragraph 8.4.3.2.1. or 8.4.3.2.2., g/test,

m_{sed} = total mass of diluted exhaust gas passing through the dilution tunnel, kg,

m_{ex} = total mass of diluted exhaust gas extracted from the dilution tunnel for particle number sampling, kg.

10.3.4. Proportionality of partial flow dilution sampling

For particle number measurement, exhaust mass flow rate, determined according to any of the methods described in paragraphs 8.4.1.3. to 8.4.1.7., is used for controlling the partial flow dilution system to take a sample proportional to the exhaust mass flow rate. The quality of proportionality shall be checked by applying a regression analysis between sample and exhaust flow in accordance with paragraph 9.4.6.1.

10.4. Determination of particle numbers

10.4.1. Time alignment

For partial flow dilution systems residence time in the particle number sampling and measurement system shall be accounted for by time aligning the particle number signal with the test cycle and the exhaust gas mass flow rate according to the procedure in paragraph 8.4.2.2. The transformation time of the particle number sampling and measurement system shall be determined according to paragraph A.8.1.3.7. of Appendix 8 to this annex.

For direct tailpipe sampling with fixed initial dilution ratio the particle number signal shall be time aligned with the exhaust flow signal using the respective transformation times. The transformation time of the particle number sampling shall be determined according to paragraph A.8.1.3.7. of Appendix 8 to this annex.

10.4.2. Determination of particle numbers with a partial flow dilution system

Where particle numbers are sampled using a partial flow dilution system according to the procedures set out in paragraph 8.4., the number of particles emitted over the test cycle shall be calculated by means of the following equation:

$$N = \frac{m_{edf}}{1.293} \cdot k \cdot \overline{c_s} \cdot \overline{f_r} \cdot 10^6 \quad (95)$$

Where:

N = number of particles emitted over the test cycle,

m_{edf} = mass of equivalent diluted exhaust gas over the cycle, determined according to paragraph 8.4.3.2.2., kg/test,

k = calibration factor to correct the particle number counter measurements to the level of the reference instrument where this is not applied internally within the particle number counter. Where the calibration factor is applied internally within the particle number counter, a value of 1 shall be used for k in the above equation,

\bar{c}_s = average concentration of particles from the diluted exhaust gas corrected to standard conditions (273.2 K and 101.33 kPa), particles per cubic centimetre,

\bar{f}_r = mean particle concentration reduction factor of the volatile particle remover specific to the dilution settings used for the test.

\bar{c}_s shall be calculated from the following equation:

$$\bar{c}_s = \frac{\sum_{i=1}^{i=n} c_{s,i}}{n} \quad (96)$$

Where:

$c_{s,i}$ = a discrete measurement of particle concentration in the diluted gas exhaust from the particle counter, to standard conditions (273.2 K and 101.33 kPa), particles per cubic centimetre,

n = number of particle concentration measurements taken over the duration of the test.

10.4.3. Determination of particle numbers

10.4.3.1. Determination of particle numbers with a full flow dilution system

Where particle numbers are sampled using a full flow dilution system according to the procedures set out in paragraph 8.5., the number of particles emitted over the test cycle shall be calculated by means of the following equation:

$$N = \frac{m_{edf}}{1.293} \cdot k \cdot \bar{c}_s \cdot \bar{f}_r \cdot 10^6 \quad (97)$$

Where:

N = number of particles emitted over the test cycle,

m_{ed} = total diluted exhaust gas flow over the cycle calculated according to any one of the methods described in paragraphs 8.5.1.2. to 8.5.1.4., kg/test,

k = calibration factor to correct the particle number counter measurements to the level of the reference instrument where this is not applied internally within the particle number counter. Where the calibration factor is applied internally within the particle number counter, a value of 1 shall be used for k in the above equation,

\bar{c}_s = average corrected concentration of particles from the diluted exhaust gas corrected to standard conditions (273.2 K and 101.33 kPa), particles per cubic centimetre,

\bar{f}_r = mean particle concentration reduction factor of the volatile particle remover specific to the dilution settings used for the test.

\bar{c}_s shall be calculated from the following equation:

$$\bar{c} = \frac{\sum_{i=1}^{i=n} c_{s,i}}{n} \quad (98)$$

Where:

$c_{s,i}$ = a discrete measurement of particle concentration in the diluted gas exhaust from the particle counter, corrected to standard conditions (273.2 K and 101.33 kPa), particles per cubic centimetre,

n = number of particle concentration measurements taken over the duration of the test.

10.4.3.2. Determination of particle numbers with raw exhaust sampling

The instantaneous particle number emissions [particles/s] shall be determined by multiplying the instantaneous concentration of the pollutant under consideration [particles/cm³] with the instantaneous exhaust mass flow rate [kg/s], both corrected and aligned for the transformation time. If applicable, negative instantaneous emission values shall enter all subsequent data evaluations. All significant digits of intermediate results shall enter the calculation of the instantaneous emissions. The following equation shall apply:

$$N_i = c_{N,i} q_{mew,i} / \rho_e$$

Where:

N_i is the particle number flux [particles/s]

$c_{N,i}$ is the measured particle number concentration normalized at 0°C [particles/m³], corrected for any calibration factors

$q_{mew,i}$ is the measured exhaust mass flow rate [kg/s] (paragraph 8.4.1.3)

ρ_e is the exhaust gas density at 0°C, 1013 mbar [kg/m³] (Table 5)

10.4.4. Test result

10.4.4.1. Calculation of the specific emissions

For each individual WHSC, hot WHTC and cold WHTC the specific emissions in number of particles/kWh shall be calculated as follows:

$$e = \frac{N}{W_{act}} \quad (99)$$

Where:

e = is the number of particles emitted per kWh,

W_{act} = is the actual cycle work according to paragraph 7.8.6., in kWh.

10.4.4.2. Exhaust after-treatment systems with periodic regeneration

For engines equipped with periodically regenerating after-treatment systems, the general provisions of paragraph 6.6.2. apply. The WHTC hot start emissions shall be weighted according to equation 5 where \bar{e} is the average number of particles/kWh without regeneration, and e_r is the average number of particles/kWh with regeneration. The calculation of the regeneration adjustment factors shall be done according to equations 6, 6a, 7 or 8, as appropriate.

10.4.4.3. Weighted average WHTC test result

For the WHTC, the final test result shall be a weighted average from cold start and hot start (including periodic regeneration where relevant) tests calculated using one of the following equations:

(a) In the case of multiplicative regeneration adjustment, or engines without periodically regenerating after-treatment

$$e = k_r \left(\frac{(0.14 \times N_{cold}) + (0.86 \times N_{hot})}{(0.14 \times W_{act,cold}) + (0.86 \times W_{act,hot})} \right) \quad (100)$$

(b) In the case of additive regeneration adjustment

$$e = k_r + \left(\frac{(0.14 \times N_{cold}) + (0.86 \times N_{hot})}{(0.14 \times W_{act,cold}) + (0.86 \times W_{act,hot})} \right) \quad (101)$$

Where:

N_{cold} = is the total number of particles emitted over the WHTC cold test cycle,

N_{hot} = is the total number of particles emitted over the WHTC hot test cycle,

$W_{act,cold}$ = is the actual cycle work over the WHTC cold test cycle according to paragraph 7.8.6., in kWh,

$W_{act,hot}$ = is the actual cycle work over the WHTC hot test cycle according to paragraph 7.8.6., in kWh,

k_r = is the regeneration adjustment, according to paragraph 6.6.2., or in the case of engines without periodically regenerating after-treatment $k_r = 1$

10.4.4.4. Rounding of final results

The final WHSC and weighted average WHTC test results shall be rounded in one step to three significant figures in accordance with ASTM E 29–06B. No rounding of intermediate values leading to the final brake specific emission result is permissible.

10.5. Determination of particle number background

10.5.1. At the engine manufacturer's request, dilution tunnel background particle number concentrations may be sampled, prior to or after the test, from a point downstream of the particle and hydrocarbon filters into the particle number measurement system, to determine the tunnel background particle concentrations.

10.5.2. Subtraction of particle number tunnel background concentrations shall not be allowed for type approval, but may be used at the manufacturer's request, with the prior approval of the Type Approval Authority, for conformity of production testing, if it can be demonstrated that tunnel background contribution is significant, which can then be subtracted from the values measured in the diluted exhaust.

The Annex 4- Appendixes 1-7 remain the same. No change.

Annex 4 - Appendix 8

Particle number emissions measurement equipment

A.8.1. Specification

A.8.1.1. System overview

A.8.1.1.1. The particle sampling system shall consist of a probe or sampling point extracting a sample from a homogeneously mixed flow in the tailpipe or in a dilution system as described in Appendix 2 to this annex, paragraph A.2.2.1. and A.2.2.2. or A.2.2.3. and A.2.2.4., a volatile particle remover (VPR) upstream of a particle number counter (PNC) and suitable transfer tubing. For direct tailpipe sampling, optionally, a pre-diluter may be included between the sampling probe or point and the VPR.

A.8.1.1.2. It is recommended that a particle size pre-classifier (e.g. cyclone, impactor, etc.) be located prior to the inlet of the VPR. However, a sample probe acting as an appropriate size-classification device, such as that shown in Appendix 2 to this annex, Figure 14, is an acceptable alternative to the use of a particle size pre-classifier. In the case of partial flow dilution systems it is acceptable to use the same pre-classifier for particulate mass and particle number sampling, extracting the particle number sample from the dilution system downstream of the pre-classifier. Alternatively separate pre-classifiers may be used, extracting the particle number sample from the dilution system upstream of the particulate mass pre-classifier.

A.8.1.2. General requirements

A.8.1.2.1. Particle transfer system

The sampling probe tip or particle sampling point and particle transfer tube (PTT), and optionally a pre-diluter for direct tailpipe sampling, together comprise the particle transfer system (PTS). The PTS conducts the sample to the entrance of the VPR.

A cold or hot pre-diluter may be located at the end of the particle sampling probe and in front of the PTT. A fixed dilution ratio >5:1 shall be applied to the cold or hot dilution stage. Cold dilution is defined as a dilution with (unheated) dilution air and/or diluter temperature $\geq 20^{\circ}\text{C}$. Indicators of whether temperatures (if applicable) and dilutions are at their correct operating ranges shall be provided.

The pre-diluter shall incorporate good aerosol sampling practice as described for the VPR in paragraphs A.8.1.2.3. and A.8.1.2.4.

The penetration for each model of pre-diluter shall be determined as described in paragraph A.8.2.2.4 separately or in combination with the VPR. The final system penetration (pre-diluter, PTT and VPR) shall not decrease 10 per cent the requirements of paragraph A.8.1.3.3.6.

The particle concentration reduction factors of each pre-diluter shall be determined as described in paragraph A.8.2.2.2. separately or in combination with the VPR and shall be taken into account in the calculation of the emissions. The complete system (pre-diluter, PTT and VPR) shall not exceed 0 per cent for 50 nm, 10 per cent for 30 nm, and 25 per cent for 15 nm (if applicable) the $fr(di)/fr(100)$ ratio requirements of paragraph A.8.1.3.3.4.

The pre-diluter shall be calibrated or validated at the same time intervals as the VPR, as given in paragraph A.8.2.2.1.

The PTS shall meet the following conditions:

In the case of full flow dilution systems and partial flow dilution systems of the fractional sampling type (as described in Appendix 2 to this annex,

paragraph A.2.2.1.) the sampling probe shall be installed near the tunnel centre line, 10 to 20 tunnel diameters downstream of the gas inlet, facing upstream into the tunnel gas flow with its axis at the tip parallel to that of the dilution tunnel. The sampling probe shall be positioned within the dilution tract so that the sample is taken from a homogeneous diluent/exhaust mixture.

In the case of partial flow dilution systems of the total sampling type (as described in Appendix 2 to this annex, paragraph A.2.2.1.) the particle sampling point or sampling probe shall be located in the particulate transfer tube, upstream of the particulate filter holder, flow measurement device and any sample/bypass bifurcation point. The sampling point or sampling probe shall be positioned so that the sample is taken from a homogeneous diluent/exhaust mixture. The dimensions of the particle sampling probe should be sized not to interfere with the operation of the partial flow dilution system.

In case of direct tailpipe sampling, the exhaust shall be sampled from the center of the exhaust stream. The SPN sampling probe shall be fitted at least 0.5 m or three times the diameter of the exhaust pipe - whichever is the larger - upstream of the exit of the exhaust gas system. Good engineering judgement should be applied to minimise or avoid water condensation at the probe. It is recommended to sample from a location representative to vehicle testing with on-board systems. It is highly recommended to measure and register the exhaust gas temperature at the sampling location.

In the case of a multi-cylinder engine with a branched exhaust manifold, the inlet of the probe shall be located sufficiently far downstream so as to ensure that the sample is representative of the average exhaust emissions from all cylinders. In multi-cylinder engines having distinct groups of manifolds, such as in a "Vee" engine configuration, it is recommended to combine the manifolds upstream of the sampling probe. If this is not practical, it is permissible to acquire a sample from the group with the highest SPN emission. For exhaust emission calculation the total exhaust mass flow shall be used.

The SPN particle sampling point or sampling probe shall be located in close proximity to the gaseous emissions sampling probe (if used) or the proportional sampling system (if used), but sufficiently distant as to not cause interference.

Sample gas drawn through the PTS shall meet the following conditions:

In the case of full flow dilution systems, it shall have a flow Reynolds number (Re) of $< 1,700$;

In the case of partial flow dilution systems, it shall have a flow Reynolds number (Re) of $< 1,700$ in the PTT i.e. downstream of the sampling probe or point;

In the case of direct tailpipe sampling, it shall have a flow Reynolds number (Re) of $< 1,700$ in the PTT.

When sampling from full flow or partial flow dilution systems or a pre-diluter, it shall have a residence time in the PTT of ≤ 3 seconds.

When sampling directly from the tailpipe the residence time until the pre-diluter or the VPR shall be ≤ 1 seconds. The tubing shall be heated at $\geq 150^{\circ}\text{C}$ if ≥ 10 cm. Good engineering judgment should be applied to minimise particle losses and insulate unheated parts.

SPN23: Any other sampling configuration for the PTS for which equivalent particle penetration at 30 nm can be demonstrated will be considered acceptable.

SPN10: Any other sampling configuration for the PTS for which equivalent particle penetration at 15 nm can be demonstrated will be considered acceptable.

The outlet tube (OT) conducting the diluted sample from the VPR to the inlet of the PNC shall have the following properties:

It shall have an internal diameter of ≥ 4 mm;

Sample gas flow through the OT shall have a residence time of ≤ 0.8 second.

SPN23: Any other sampling configuration for the OT for which equivalent particle penetration at 30 nm can be demonstrated will be considered acceptable.

SPN10: Any other sampling configuration for the OT for which equivalent particle penetration at 15 nm can be demonstrated will be considered acceptable.

- A.8.1.2.2. The VPR shall include devices for sample dilution and for volatile particle removal
- A.8.1.2.3. All parts of the dilution system and the sampling system from the exhaust pipe up to the PNC, which are in contact with raw and diluted exhaust gas, shall be made of electrically conductive materials, shall be electrically grounded to prevent electrostatic effects and designed to minimize deposition of the particles.
- A.8.1.2.4. The particle sampling system shall incorporate good aerosol sampling practice that includes the avoidance of sharp bends and abrupt changes in cross-section, the use of smooth internal surfaces and the minimisation of the length of the sampling line. Gradual changes in the cross-section are permissible
- A.8.1.3. Specific requirements
- A.8.1.3.1. The particle sample shall not pass through a pump before passing through the PNC.
- A.8.1.3.2. A sample pre-classifier is recommended.
- A.8.1.3.3. The VPR shall:
- A.8.1.3.3.1. Be capable of diluting the sample in one or more stages to achieve a particle number concentration below the upper threshold of the single particle count mode of the PNC below a maximum allowed inlet temperature specified by the PNC manufacturer;
- A.8.1.3.3.2. **SPN23:** Include an initial heated dilution stage which outputs a sample at a temperature of ≥ 150 °C and ≤ 350 °C ± 10 °C, and dilutes by a factor of at least 10.
- SPN10:** Include an initial heated dilution stage which outputs a sample at a temperature of ≥ 150 °C and ≤ 350 °C ± 10 °C, and dilutes by a factor of at least 10.
- A.8.1.3.3.3. Control heated stages to constant nominal operating temperatures, within the range specified in paragraph A.8.1.3.3.2., to a tolerance of ± 10 C. Provide an indication of whether or not heated stages are at their correct operating temperatures;
- A.8.1.3.3.4. **SPN23:** Achieve a particle concentration reduction factor ($f_r(d_i)$), as defined in paragraph A.8.2.2.2. below, for particles of 30 nm and 50 nm electrical mobility diameters, that is no more than 30 per cent and 20 per cent respectively higher, and no more than 5 per cent lower than that for particles of 100 nm electrical mobility diameter for the VPR as a whole;
- SPN10:** Achieve a particle concentration reduction factor ($f_r(d_i)$), as defined in paragraph A.8.2.2.2. below, for particles of 15 nm, 30 nm and 50 nm electrical mobility diameters, that is no more than 100 per cent, 30 per cent and 20 per

cent respectively higher, and no more than 5 per cent lower than that for particles of 100 nm electrical mobility diameter for the VPR as a whole;

- A.8.1.3.3.5. **SPN23:** Also achieve > 99.0 per cent vaporisation of 30 nm tetracontane ($\text{CH}_3(\text{CH}_2)_{38}\text{CH}_3$) particles, with an inlet concentration of $\geq 10,000 \text{ cm}^{-3}$, by means of heating and reduction of partial pressures of the tetracontane.

SPN10: Achieve more than 99.9 per cent vaporization of tetracontane ($\text{CH}_3(\text{CH}_2)_{38}\text{CH}_3$) particles with count median diameter > 50 nm and mass > 1 mg/m^3 , by means of heating and reduction of partial pressures of the tetracontane.

- A.8.1.3.3.6. Achieve a solid particle penetration efficiency of at least 70 per cent for particles of 100 nm electrical mobility diameter (as defined in paragraph A.8.2.2.4).

- A.8.1.3.4. The PNC shall:

- A.8.1.3.4.1. Operate under full flow operating conditions;

- A.8.1.3.4.2. Have a counting accuracy of ± 10 per cent across the range 1 cm^{-3} to the upper threshold of the single particle count mode of the PNC against a traceable standard. At concentrations below 100 cm^{-3} measurements averaged over extended sampling periods may be required to demonstrate the accuracy of the PNC with a high degree of statistical confidence;

- A.8.1.3.4.3. Have a readability of at least 0.1 particle cm^{-3} at concentrations below 100 cm^{-3} ;

- A.8.1.3.4.4. Have a linear response to particle concentrations over the full measurement range in single particle count mode;

- A.8.1.3.4.5. Have a data reporting frequency equal to or greater than 0.5 Hz;

- A.8.1.3.4.6. Have a t_{90} response time over the measured concentration range of less than 5 s;

- A.8.1.3.4.7. **SPN23:** Incorporate a calibration factor from the linearity calibration against a traceable reference, as determined in paragraph A.8.2.1.3., to determine PNC counting efficiency. The counting efficiency shall be reported including the calibration factor.

SPN10: Incorporate a calibration factor from the linearity calibration against a traceable reference, as determined in paragraph A.8.2.1.3., to determine PNC counting efficiency. The counting efficiency shall be reported including the calibration factor. The PNC calibration material shall be 4cSt polyalphaolefin (Emery oil) or soot-like particles (e.g. flame generated soot or graphite particles).

- A.8.1.3.4.8. **SPN23:** Have counting efficiencies at particle sizes of 23 nm (± 1 nm) and 41 nm (± 1 nm) electrical mobility diameter of 50 per cent (± 12 per cent) and > 90 per cent respectively. These counting efficiencies may be achieved by internal (for example; control of instrument design) or external (for example; size pre-classification) means;

SPN10: Have counting efficiencies at nominal particle sizes of 10 nm and 15 nm electrical mobility diameter of 65 per cent (± 15 per cent) and >90 per cent respectively. These counting efficiencies may be achieved by internal (for example; control of instrument design) or external (for example; size pre-classification) means;

- A.8.1.3.4.9. If the PNC makes use of a working liquid, it shall be replaced at the frequency specified by the instrument manufacturer.

- A.8.1.3.5. Where not held at a known constant level at the point at which PNC flow rate is controlled, the pressure and/or temperature at the PNC inlet shall be measured for the purposes of correcting particle number concentration

measurements to standard conditions. The standard conditions are 101.325 kPa pressure and 0°C temperature.

- A.8.1.3.6. The sum of the residence time of the PTS, VPR and OT plus the t_{90} response time of the PNC shall be no greater than 20 s.
- A.8.1.3.7. The transformation time of the entire particle number sampling system (PTS, VPR, OT and PNC) shall be determined by aerosol switching directly at the inlet of the PTS. The aerosol switching shall be done in less than 0.1 s. The aerosol used for the test shall cause a concentration change of at least 60 per cent full scale (FS).

The concentration trace shall be recorded. For time alignment of the particle number concentration and exhaust flow signals, the transformation time is defined as the time from the change (t_0) until the response is 50 per cent of the final reading (t_{50}).

A.8.1.4. Recommended system description

The following paragraph contains the recommended practice for measurement of particle number. However, any system meeting the performance specifications in paragraphs A.8.1.2. and A.8.1.3. is acceptable.

Figures 19, 20, and 21 are schematic drawings of the recommended particle sampling system configures for partial, full flow dilution and tailpipe systems respectively.

Figure 19

Schematic of recommended particle sampling system – Partial flow sampling

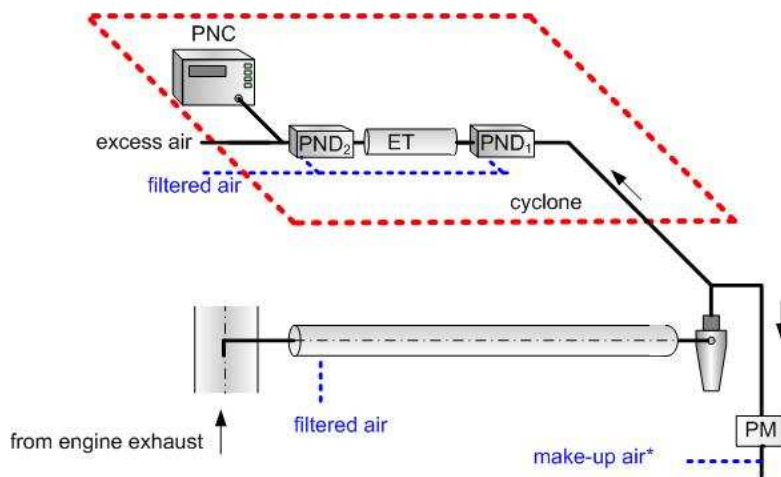

* Alternatively, the control software might account for the flow removed by the PN system

Figure 20
Schematic of recommended particle sampling system – Full flow sampling

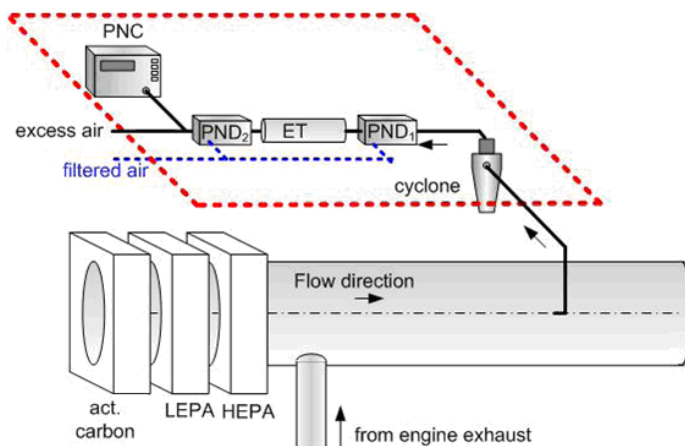
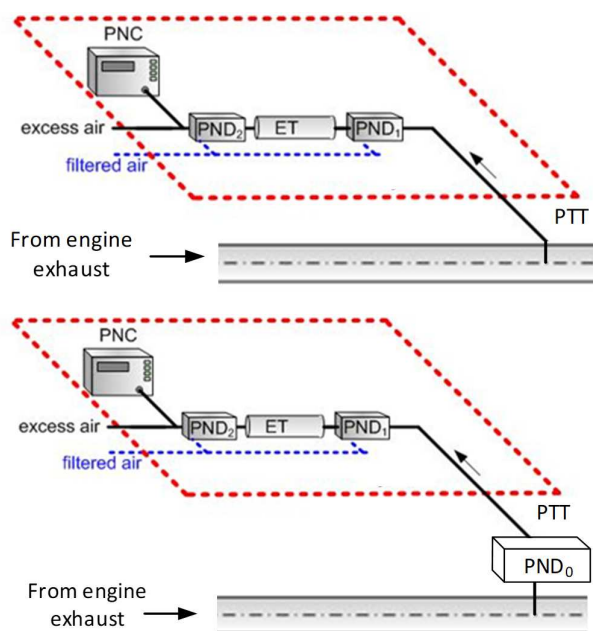

Figure 21
Schematic of recommended particle sampling system – Tailpipe sampling (i) without pre-diluter; (ii) with pre-diluter.



A.8.1.4.1. Sampling system description

The particle sampling system shall consist of a sampling probe tip or particle sampling point in the dilution system or tailpipe, a particle transfer tube (PTT), a particle pre-classifier (PCF) and a volatile particle remover (VPR) upstream of the particle number concentration measurement (PNC) unit. For direct tailpipe sampling, optionally, a pre-diluter may be included between the sampling probe or point and the VPR. The VPR shall include devices for sample dilution (particle number diluters: PND1 and PND2) and particle evaporation (Evaporation tube, ET). The sampling probe or sampling point for the test gas flow shall be so arranged within the dilution tract that a representative sample gas flow is taken from a homogeneous diluent/exhaust mixture. The sum of the residence time of the system plus the t_{90} response time of the PNC shall be no greater than 20 s.

A.8.1.4.2. Particle transfer system

The sampling probe tip or particle sampling point and particle transfer tube (PTT), and optionally a pre-diluter for direct tailpipe sampling, together comprise the particle transfer system (PTS). The PTS conducts the sample to the entrance of the VPR.

A cold or hot pre-diluter may be located at the end of the particle sampling probe and in front of the PTT. A fixed dilution ratio $>5:1$ shall be applied to the cold or hot dilution stage. Cold dilution is defined as a dilution with (unheated) dilution air and/or diluter temperature $\geq 20^{\circ}\text{C}$. Indicators of whether temperatures (if applicable) and dilutions are at their correct operating ranges shall be provided.

The pre-diluter shall incorporate good aerosol sampling practice as described for the VPR in paragraphs A.8.1.2.3. and A.8.1.2.4.

The penetration for each model of pre-diluter shall be determined as described in paragraph A.8.2.2.4 separately or in combination with the VPR. The final system penetration (pre-diluter, PTT and VPR) shall not decrease 10 per cent the requirements of paragraph A.8.1.3.3.6.

The particle concentration reduction factors of each pre-diluter shall be determined as described in paragraph A.8.2.2.2. separately or in combination with the VPR and shall be taken into account in the calculation of the emissions. The complete system (pre-diluter, PTT and VPR) shall not exceed 0 per cent for 50 nm, 10 per cent for 30 nm, and 25 per cent for 15 nm (if applicable) the $fr(di)/fr(100)$ ratio requirements of paragraph A.8.1.3.3.4.

The pre-diluter shall be calibrated or validated at the same time intervals as the VPR, as given in paragraph A.8.2.2.1.

The PTS shall meet the following conditions:

In the case of full flow dilution systems and partial flow dilution systems of the fractional sampling type (as described in Appendix 2 to this annex, paragraph A.2.2.1.) the sampling probe shall be installed near the tunnel centre line, 10 to 20 tunnel diameters downstream of the gas inlet, facing upstream into the tunnel gas flow with its axis at the tip parallel to that of the dilution tunnel. The sampling probe shall be positioned within the dilution tract so that the sample is taken from a homogeneous diluent/exhaust mixture.

In the case of partial flow dilution systems of the total sampling type (as described in Appendix 2 to this annex, paragraph A.2.2.1.) the particle sampling point shall be located in the particulate transfer tube, upstream of the particulate filter holder, flow measurement device and any sample/bypass bifurcation point. The sampling point or sampling probe shall be positioned so that the sample is taken from a homogeneous diluent/exhaust mixture.

In case of direct tailpipe sampling, the exhaust shall be sampled from the center of the exhaust stream. The SPN sampling probe shall be fitted at least 0.5 m or three times the diameter of the exhaust pipe - whichever is the larger - upstream of the exit of the exhaust gas system. Good engineering judgement should be applied to minimise or avoid water condensation at the probe. It is recommended to sample from a location representative to vehicle testing with on-board systems. It is highly recommended to measure and register the exhaust gas temperature at the sampling location.

In the case of a multi-cylinder engine with a branched exhaust manifold, the inlet of the probe shall be located sufficiently far downstream so as to ensure that the sample is representative of the average exhaust emissions from all cylinders. In multi-cylinder engines having distinct groups of manifolds, such as in a "Vee" engine configuration, it is recommended to combine the manifolds upstream of the sampling probe. If this is not practical, it is

permissible to acquire a sample from the group with the highest SPN emission. For exhaust emission calculation the total exhaust mass flow shall be used.

The SPN particle sampling point or sampling probe shall be located in close proximity to the gaseous emissions sampling probe (if used) or the proportional sampling system (if used), but sufficiently distant as to not cause interference.

Sample gas drawn through the PTS shall meet the following conditions:

It shall have a flow Reynolds number (Re) of $< 1,700$;

When sampling from full flow or partial flow dilution systems or a pre-diluter, it shall have a residence time in the PTT of ≤ 3 seconds.

When sampling directly from the tailpipe the residence time until the pre-diluter or the VPR shall be ≤ 1 seconds. The tubing shall be heated at $\geq 150^\circ\text{C}$ if ≥ 10 cm. Good engineering judgment should be applied to minimise particle losses and insulate unheated parts.

SPN23: Any other sampling configuration for the PTS for which equivalent particle penetration for particles of 30 nm electrical mobility diameter can be demonstrated will be considered acceptable.

SPN10: Any other sampling configuration for the PTS for which equivalent particle penetration for particles of 15 nm electrical mobility diameter can be demonstrated will be considered acceptable.

The outlet tube (OT) conducting the diluted sample from the VPR to the inlet of the PNC shall have the following properties:

It shall have an internal diameter of ≥ 4 mm;

Sample gas flow through the OT shall have a residence time of ≤ 0.8 second.

SPN23: Any other sampling configuration for the OT for which equivalent particle penetration for particles of 30 nm electrical mobility diameter can be demonstrated will be considered acceptable.

SPN10: Any other sampling configuration for the OT for which equivalent particle penetration for particles of 15 nm electrical mobility diameter can be demonstrated will be considered acceptable.

A.8.1.4.3. Particle pre-classifier

The recommended particle pre-classifier shall be located upstream of the VPR. The pre-classifier 50 per cent cut point particle diameter shall be between 2.5 μm and 10 μm at the volumetric flow rate selected for sampling particle number emissions. The pre-classifier shall allow at least 99 per cent of the mass concentration of 1 μm particles entering the pre-classifier to pass through the exit of the pre-classifier at the volumetric flow rate selected for sampling particle number emissions. In the case of partial flow dilution systems, it is acceptable to use the same pre-classifier for particulate mass and particle number sampling, extracting the particle number sample from the dilution system downstream of the pre-classifier. Alternatively separate pre-classifiers may be used, extracting the particle number sample from the dilution system upstream of the particulate mass pre-classifier.

A.8.1.4.4. Volatile particle remover (VPR)

The VPR shall comprise one particle number diluter (PND₁), an evaporation tube and a second diluter (PND₂) in series. This dilution function is to reduce the number concentration of the sample entering the particle concentration measurement unit to less than the upper threshold of the single particle count mode of the PNC and to suppress nucleation within the sample. The VPR shall provide an indication of whether or not PND₁ and the evaporation tube are at their correct operating temperatures.

SPN23: The VPR shall achieve > 99.0 per cent vaporisation of 30 nm tetracontane ($\text{CH}_3(\text{CH}_2)_{38}\text{CH}_3$) particles, with an inlet concentration of $\geq 10,000 \text{ cm}^{-3}$, by means of heating and reduction of partial pressures of the tetracontane.

It shall also achieve a particle concentration reduction factor (f_r) for particles of 30 nm and 50 nm electrical mobility diameters, that is no more than 30 per cent and 20 per cent respectively higher, and no more than 5 per cent lower than that for particles of 100 nm electrical mobility diameter for the VPR as a whole.

SPN10: The VPR shall achieve more than 99.9 per cent vaporization of tetracontane ($\text{CH}_3(\text{CH}_2)_{38}\text{CH}_3$) particles with count median diameter > 50 nm and mass > 1 mg/m^3 , by means of heating and reduction of partial pressures of the tetracontane.

It shall also achieve a particle concentration reduction factor (f_r) for particles of 15 nm, 30 nm and 50 nm electrical mobility diameters, that is no more than 100 per cent, 30 per cent and 20 per cent respectively higher, and no more than 5 per cent lower than that for particles of 100 nm electrical mobility diameter for the VPR as a whole.

A.8.1.4.4.1. First particle number dilution device (PND₁)

The first particle number dilution device shall be specifically designed to dilute particle number concentration and operate at a (wall) temperature of 150 °C to 400 °C. The wall temperature setpoint should be held at a constant nominal operating temperature, within this range, to a tolerance of ± 10 °C and not exceed the wall temperature of the ET (paragraph A.8.1.4.4.2.). The diluter should be supplied with HEPA filtered dilution air and be capable of a dilution factor of 10 to 200 times.

A.8.1.4.4.2. Evaporation Tube (ET)

The entire length of the ET shall be controlled to a wall temperature greater than or equal to that of the first particle number dilution device and the wall temperature held at a fixed nominal operating temperature between 300 °C and 400 °C, to a tolerance of ± 10 °C.

A.8.1.4.4.3. **SPN23:** The ET may be catalytically active.

SPN10: The ET shall be catalytically active.

A.8.1.4.4.4. Second particle number dilution device (PND₂)

PND₂ shall be specifically designed to dilute particle number concentration. The diluter shall be supplied with HEPA filtered dilution air and be capable of maintaining a single dilution factor within a range of 10 to 30 times. The dilution factor of PND₂ shall be selected in the range between 10 and 15 such that particle number concentration downstream of the second diluter is less than the upper threshold of the single particle count mode of the PNC and the gas temperature prior to entry below a maximum allowed inlet temperature specified by the PNC manufacturer.

A.8.1.4.5. Particle number counter (PNC)

The PNC shall meet the requirements of paragraph A.8.1.3.4.

A.8.2. Calibration/Validation of the particle sampling system

A.8.2.1. Calibration of the particle number counter

A.8.2.1.1. The Technical Service shall ensure the existence of a calibration certificate for the PNC demonstrating compliance with a traceable standard within a 13-month period prior to the emissions test. Between calibrations either the counting efficiency of the PNC shall be monitored for deterioration or the PNC

wick shall be routinely changed every 6 months if recommended by the instrument manufacturer.

The responsible authority shall ensure the existence of a calibration certificate for the PNC demonstrating compliance with a traceable standard within a 13-month period prior to the emissions test. Between calibrations either the counting efficiency of the PNC shall be monitored for deterioration or the PNC wick shall be routinely changed every 6 months if recommended by the instrument manufacturer. See Figures 22 and 23. PNC counting efficiency may be monitored against a reference PNC or against at least two other measurement PNCs. If the PNC reports particle number concentrations within ± 10 per cent of the arithmetic average of the concentrations from the reference PNC, or a group of two or more PNCs, the PNC shall subsequently be considered stable, otherwise maintenance of the PNC is required. Where the PNC is monitored against two or more other measurement PNCs, it is permitted to use a reference vehicle running sequentially in different test cells each with its own PNC.

Figure 22
Nominal PNC annual sequence

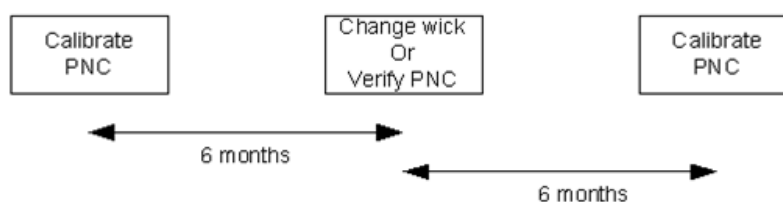
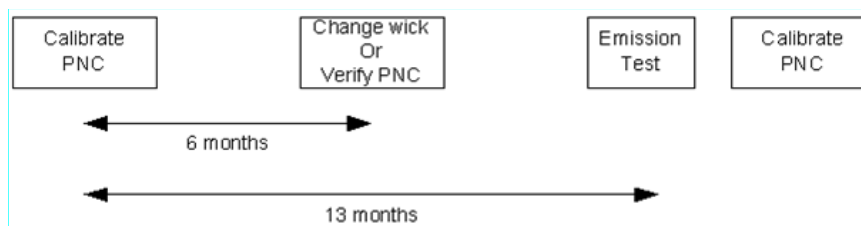

Figure 23
Extended PNC annual sequence (in the case that a full PNC calibration is delayed)



A.8.2.1.2. The PNC shall also be recalibrated and a new calibration certificate issued following any major maintenance.

A.8.2.1.3. Calibration shall be traceable to a standard calibration method:

- (a) By comparison of the response of the PNC under calibration with that of a calibrated aerosol electrometer when simultaneously sampling electrostatically classified calibration particles; or
- (b) By comparison of the response of the PNC under calibration with that of a second PNC which has been directly calibrated by the above method.

The calibration shall be undertaken using at least six standard concentrations across the PNC's measurement range. Five of these standard concentrations shall be as uniformly spaced as possible between the standard concentration of 2,000 particles per cm^3 or below and the maximum of the PNC's range in single particle count mode. The six standard concentrations points shall include a nominal zero concentration point produced by attaching HEPA filters of at least Class H13 of EN 1822:2008, or equivalent performance, to the inlet of each instrument. The gradient from a linear least squares regression of the two data sets shall be calculated and recorded. A calibration factor equal to the reciprocal of the gradient shall be applied to the PNC under calibration. Linearity of response is calculated as the square of the Pearson product moment correlation coefficient (r) of the two data sets and shall be equal to or greater

than 0.97. In calculating both the gradient and r^2 , the linear regression shall be forced through the origin (zero concentration on both instruments). The calibration factor shall be between 0.9 and 1.1. Each concentration measured with the PNC under calibration, shall be within ± 5 per cent of the measured reference concentration multiplied with the gradient, with the exception of the zero point.

A.8.2.1.4. **SPN23:** Calibration shall also include a check, against the requirements in paragraph A.8.1.3.4.8., on the PNC's counting efficiency with particles of 23 nm electrical mobility diameter. A check of the counting efficiency with 41 nm particles is not required during periodical calibration.

SPN10: Calibration shall also include a check, against the requirements in paragraph A.8.1.3.4.8., on the PNC's detection efficiency with particles of 10 nm electrical mobility diameter. A check of the counting efficiency with 15 nm particles is not required during periodical calibration.

A.8.2.2. Calibration/Validation of the volatile particle remover

A.8.2.2.1. Calibration of the VPR's particle concentration reduction factors across its full range of dilution settings, at the instrument's fixed nominal operating temperatures, shall be required when the unit is new and following any major maintenance. The periodic validation requirement for the VPR's particle concentration reduction factor is limited to a check at a single setting, typical of that used for measurement on diesel particulate filter equipped vehicles. The Technical Service shall ensure the existence of a calibration or validation certificate for the volatile particle remover within a 6-month period prior to the emissions test. If the volatile particle remover incorporates temperature monitoring alarms a 13-month validation interval shall be permissible.

SPN23: The VPR shall be characterised for particle concentration reduction factor with solid particles of 30 nm, 50 nm and 100 nm electrical mobility diameter. Particle concentration reduction factors ($f_r(d)$) for particles of 30 nm and 50 nm electrical mobility diameters shall be no more than 30 per cent and 20 per cent higher respectively, and no more than 5 per cent lower than that for particles of 100 nm electrical mobility diameter. For the purposes of validation, the mean particle concentration reduction factor shall be within ± 10 per cent of the mean particle concentration reduction factor (\bar{f}_r) determined during the primary calibration of the VPR.

SPN10: The VPR shall be characterised for particle concentration reduction factor with solid particles of 15 nm, 30 nm, 50 nm and 100 nm electrical mobility diameter. Particle concentration reduction factors ($f_r(d)$) for particles of 15 nm, 30 nm and 50 nm electrical mobility diameters shall be no more than 100 per cent, 30 per cent and 20 per cent higher respectively, and no more than 5 per cent lower than that for particles of 100 nm electrical mobility diameter. For the purposes of validation, the mean particle concentration reduction factor shall be within ± 10 per cent of the mean particle concentration reduction factor (\bar{f}_r) determined during the primary calibration of the VPR. $f_r(d)$.

A.8.2.2.2. **SPN23:** The test aerosol for these measurements shall be solid particles of 30, 50 and 100 nm electrical mobility diameter and a minimum concentration of 5,000 particles cm^{-3} at the VPR inlet. Particle concentrations shall be measured upstream and downstream of the components.

SPN10: The test aerosol for these measurements shall be solid particles of 30, 50 and 100 nm electrical mobility diameter of a minimum concentration of 5,000 particles per cm^3 and a minimum concentration of 3,000 particles per cm^3 of 15 nm electrical mobility diameter at the VPR inlet. Particle concentrations shall be measured upstream and downstream of the components.

The particle concentration reduction factor at each particle size ($f_r(d_i)$) shall be calculated as follows:

$$f_r(d_i) = \frac{N_{in}(d_i)}{N_{out}(d_i)} \quad (117)$$

Where:

$N_{in}(d_i)$ = upstream particle number concentration for particles of diameter d_i

$N_{out}(d_i)$ = downstream particle number concentration for particles of diameter d_i and

SPN23: d_i = particle electrical mobility diameter (30, 50 or 100 nm)

SPN10: d_i = particle electrical mobility diameter (15, 30, 50 or 100 nm)

$N_{in}(d_i)$ and $N_{out}(d_i)$ shall be corrected to the same conditions.

The mean particle concentration reduction () at a given dilution setting shall be calculated as follows:

$$\bar{f}_r = \frac{f_r(30nm) + f_r(50nm) + f_r(100nm)}{3} \quad (118)$$

It is recommended that the VPR is calibrated and validated as a complete unit.

- A.8.2.2.3. The volatile particle removal efficiency of a VPR needs to be proven only once for the instrument family. The instrument manufacturer must provide the maintenance or replacement interval that ensures that the removal efficiency of the VPR does not drop below the technical requirements. If such information is not provided, the volatile removal efficiency has to be checked at 13-month intervals for each instrument.

SPN23: The VPR shall demonstrate greater than 99.0 per cent removal of tetracontane ($\text{CH}_3(\text{CH}_2)_{38}\text{CH}_3$) particles of at least 30 nm electrical mobility diameter with an inlet concentration of $\geq 10,000 \text{ cm}^{-3}$ when operated at its minimum dilution setting and manufacturers recommended operating temperature.

SPN10: The VPR shall demonstrate greater than 99.9 per cent removal efficiency of Tetracontane ($\text{CH}_3(\text{CH}_2)_{38}\text{CH}_3$) particles with count median diameter $> 50 \text{ nm}$ and mass $> 1 \text{ mg/m}^3$ when operated at its minimum dilution setting and manufacturers recommended operating temperature.

- A.8.2.2.4. The instrument manufacturer shall prove the solid particle penetration $P_r(d_i)$ by testing one unit for each SPN-system model. A SPN-system model here covers all SPN-systems with the same hardware, i.e. same geometry, conduit materials, flows and temperature profiles in the aerosol path.

$$P_r(d_i) = DF \cdot N_{out}(d_i) / N_{in}(d_i)$$

Where

$N_{in}(d_i)$ is the upstream particle number concentration for particles of diameter d_i ;

$N_{out}(d_i)$ is the downstream particle number concentration for particles of diameter d_i ;

d_i is the particle electrical mobility diameter

DF is the dilution factor between measurement positions of $N_{in}(d_i)$ and $N_{out}(d_i)$ determined either with trace gases, or flow measurements.

- A.8.2.3. Particle number system check procedures

- A.8.2.3.1. Prior to each test, the particle counter shall report a measured concentration of less than $0.5 \text{ particles cm}^{-3}$ when a HEPA filter of at least class H13 of EN 1822:2008, or equivalent performance, is attached to the inlet of the entire particle sampling system (VPR and PNC).

- A.8.2.3.2. On a monthly basis, the flow into the PNC shall have a measured value within 5 per cent of the PNC nominal flow rate when checked with a calibrated flow meter. Here the term 'nominal flow rate' refers to the flow rate stated in the last calibration for the PNC by the manufacturer.
 - A.8.2.3.3. Each day, a zero check on the PNC, using a filter of appropriate performance at the PNC inlet, shall report a concentration of ≤ 0.2 particles per cm^3 . Upon removal of the filter, the PNC shall show an increase in measured concentration and a return to ≤ 0.2 particles per cm^3 on replacement of the filter. The PNC shall not report any errors.
 - A.8.2.3.4. Prior to the start of each test it shall be confirmed that the measurement system indicates that the evaporation tube, where featured in the system, has reached its correct operating temperature.
 - A.8.2.3.5. Prior to the start of each test it shall be confirmed that the measurement system indicates that the diluter PND₁ has reached its correct operating temperature.
-