

Submitted by the expert from the European
Association of Automotive Suppliers
(CLEPA)

Informal document **GRVA-09-06**
9th GRVA, 1-5 February 2021
Provisional agenda item 8(b)

UN R13 and Electro Mechanical Brakes

Introduction

UN Regulation 13 defines:

- **Transmission** means the combination of components comprised between the control and the brake and linking them functionally. *The transmission may be mechanical, hydraulic, pneumatic, electric or mixed.*
- **Control Transmission** - means the combination of the components of the transmission which control the operation of the brakes, including the control function and the necessary reserve(s) of energy.
- **Energy Transmission** - means the combination of the components which supply to the brakes the necessary energy for their function, including the reserve(s) of energy necessary for the operation of the brakes.

→ *The transmission may be mechanical, hydraulic, pneumatic, electric or mixed.*

UN R13 was updated in 1990s to account for an electronic “Control Transmission” but still assumes Pneumatic “Energy Transmission” in the service braking system.

- **Pneumatic Energy limitation is shown in two ways:**
 - Design Specifications – E.g. Where limits are in kPa.
 - Design Limitations – E.g. Where it is assumed air is the medium.

- **Electro Mechanical Brake Technology** is being developed by the industry using *Electric Energy Transmission* in the service braking system and the UN R13 needs to be updated accordingly.

UN R13 and Electro Mechanical Brakes (EMB)

Amendment scope and motivation

- Motor vehicle with EMB brakes on all axles (not mixed with Pneumatic Or Hydraulic systems)
- Motor vehicle with EMB brakes with “conventional” trailer interface according to UN R13
- Trailers with EMB excluded from scope
- UN R13-H not included but considered, in particular when creating new definitions

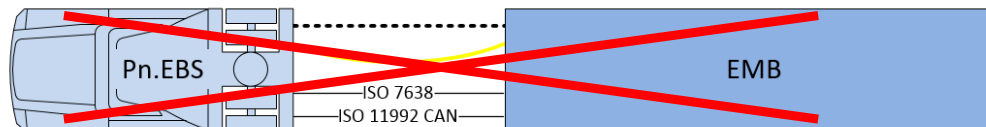
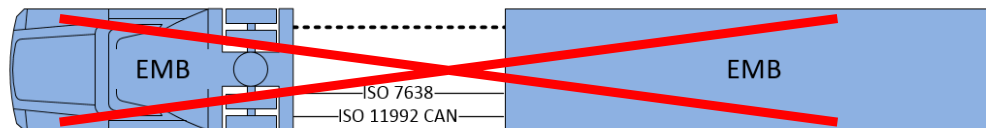
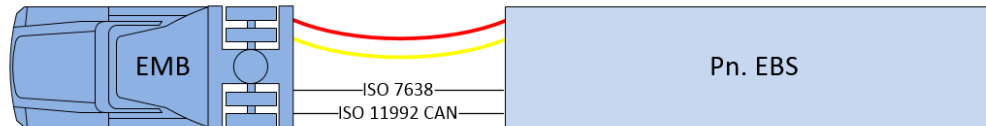
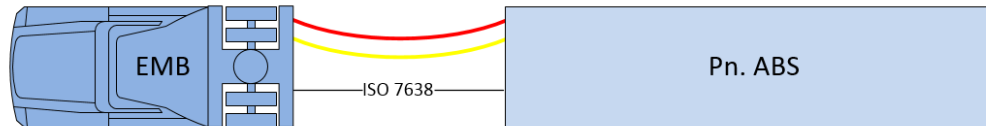
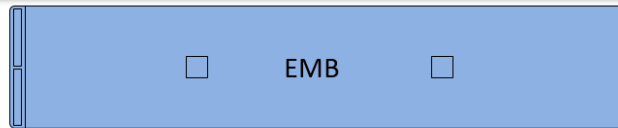
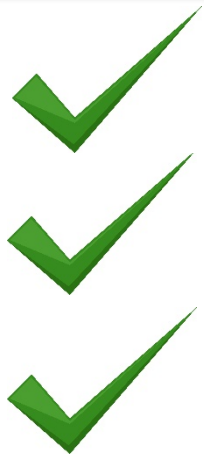

Advantages and possibilities by amending *Electric Energy Transmission* to UN R13

- Improved energy efficiency in EV's (vs. air compressor)
- Improved braking control
- Elimination of noise emissions from pneumatics

UN R13 and Electro Mechanical Brakes (EMB) Electrification Development

- Improved Vehicle Dynamics Control
- Emission reduction
- Energy efficiency



Hybrid Electric vehicles

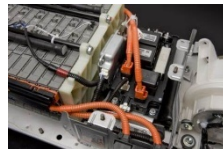

EBS in Commercial vehicles – (electronic control transmission)



Electric parking brake

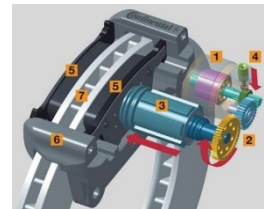

Electric Power Steering



Full Electric Vehicles

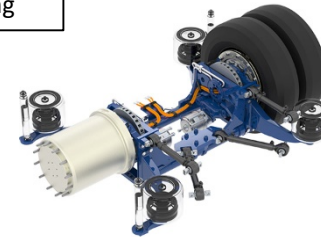

EMB in Commercial vehicles – (electronic control transmission and electric service braking)



Improved Vehicle Dynamics Control

- Reduced response time enhancing braking performance.
- Optimized control of safety functions like ABS, ESP, AEBS or Traction control.

Emission reduction

- Reduction of noise vs. pneumatic brake systems.

Energy efficiency

- Significant higher energy efficiency vs. pneumatic brake systems.
- Potential to reduce CO2.

Other

- Weight and space savings
- Easier packaging

Main parts to be amended

2. Definitions

New paragraphs defining **Electric Energy Transmission** (e,g **Energy Source, Electrical Storage device, Electrical Supply device**)

5.1.4.6 Reference Braking forces

New paragraph 5.1.4.6.2.

Reference braking forces for electro-mechanical braking system using a roller brake tester shall be defined according to the following requirements.

5.2 Characteristics of Braking Systems.

New paragraph 5.2.1.34.

Special additional requirements for service braking systems with electric control and energy transmissions.

Annex 7, (provisions relating to energy supply and storage)

New Part D

Electro-mechanical Braking system

UN R13 and Electro Mechanical Brakes (EMB) Energy Transmission principles (Pneumatic vs. Electric)

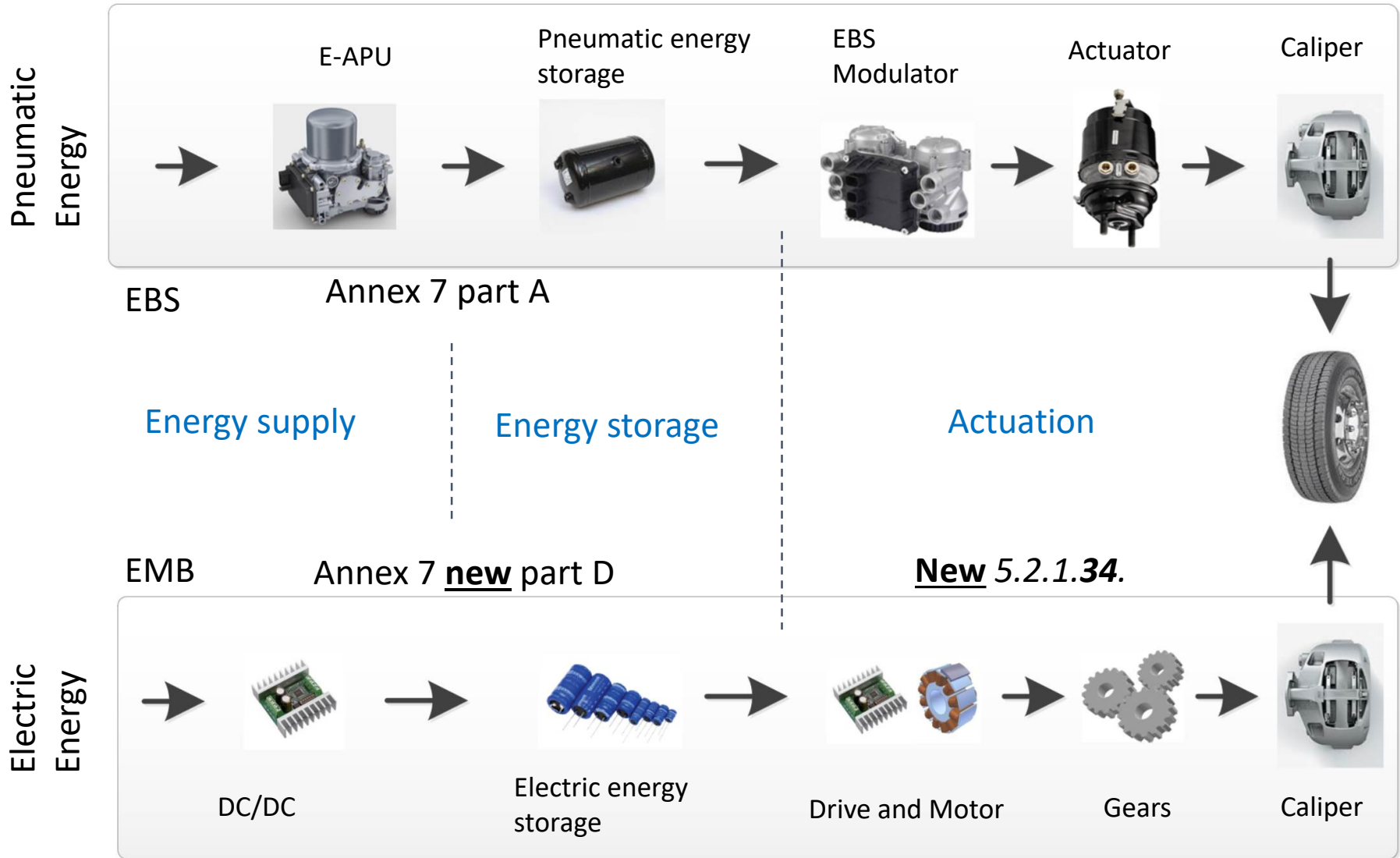

UN R13 and Electro Mechanical Brakes (EMB)

Development steps comparison

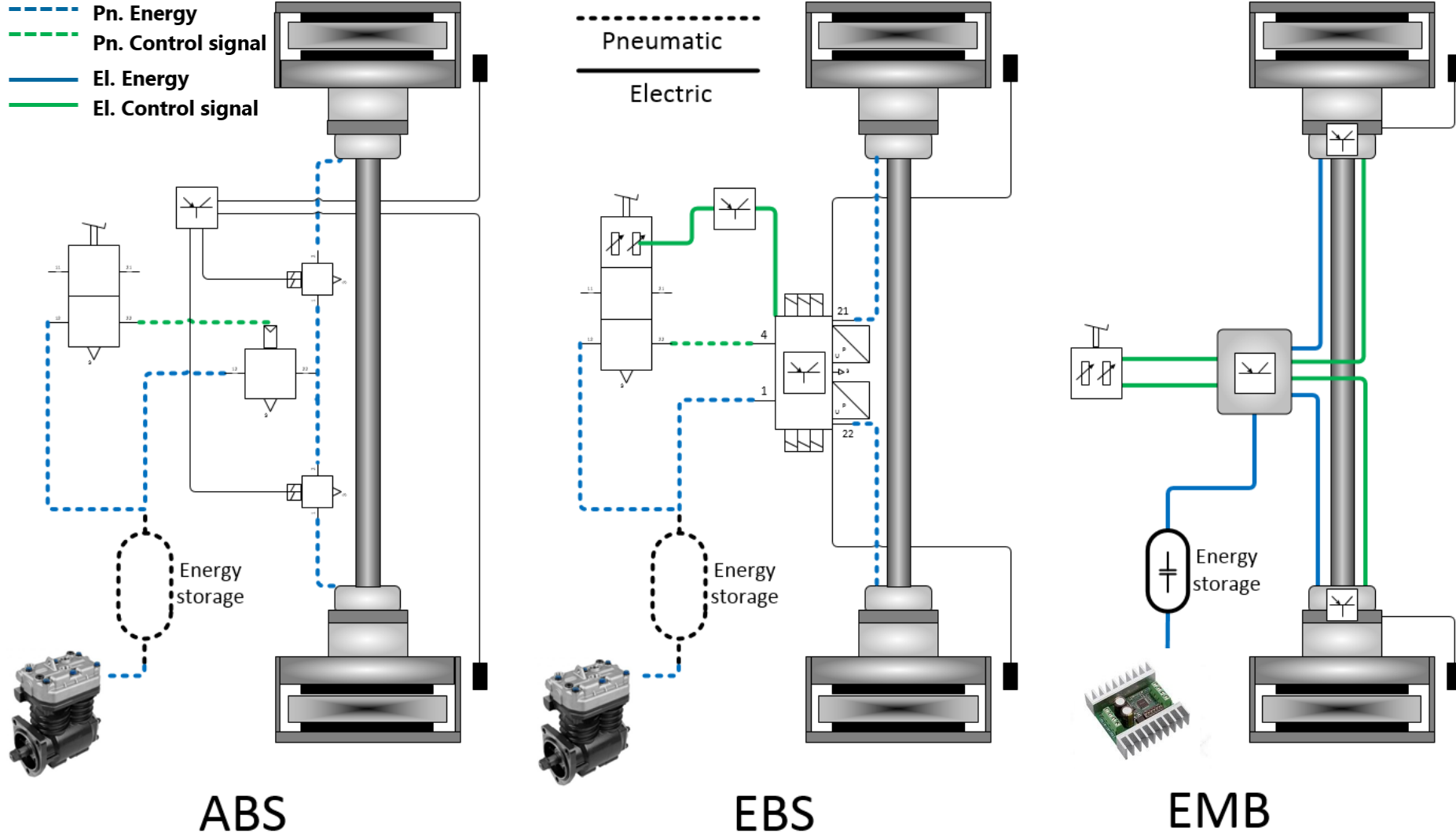

Principal layouts shown

Example EBS system of today in vehicle with combustion engine

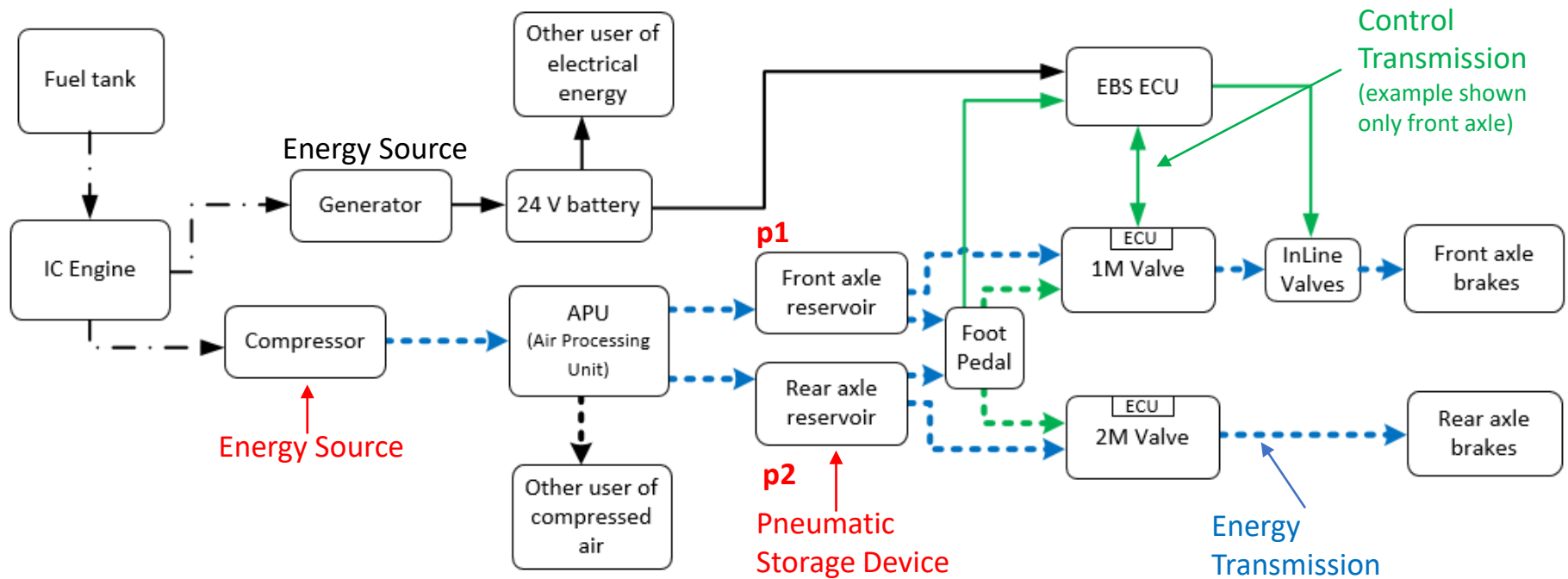

p1 and p2: Pneumatic energy monitoring and warning if storage falls below a certain level.

Example EMB system in electric vehicle

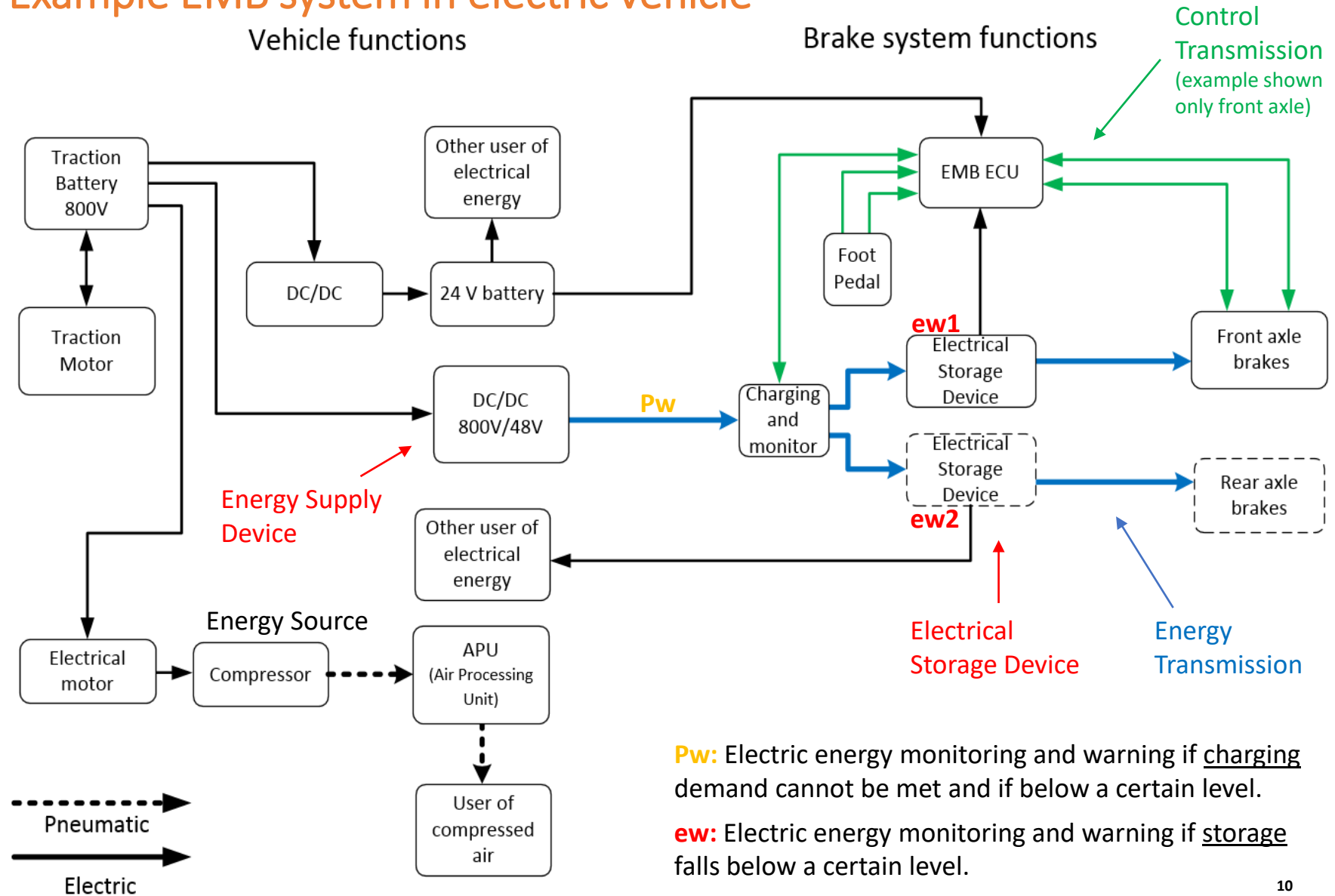

Pw: Electric energy monitoring and warning if charging demand cannot be met and if below a certain level.

ew: Electric energy monitoring and warning if storage falls below a certain level.

System Description

Energy content of electric storage device – example battery

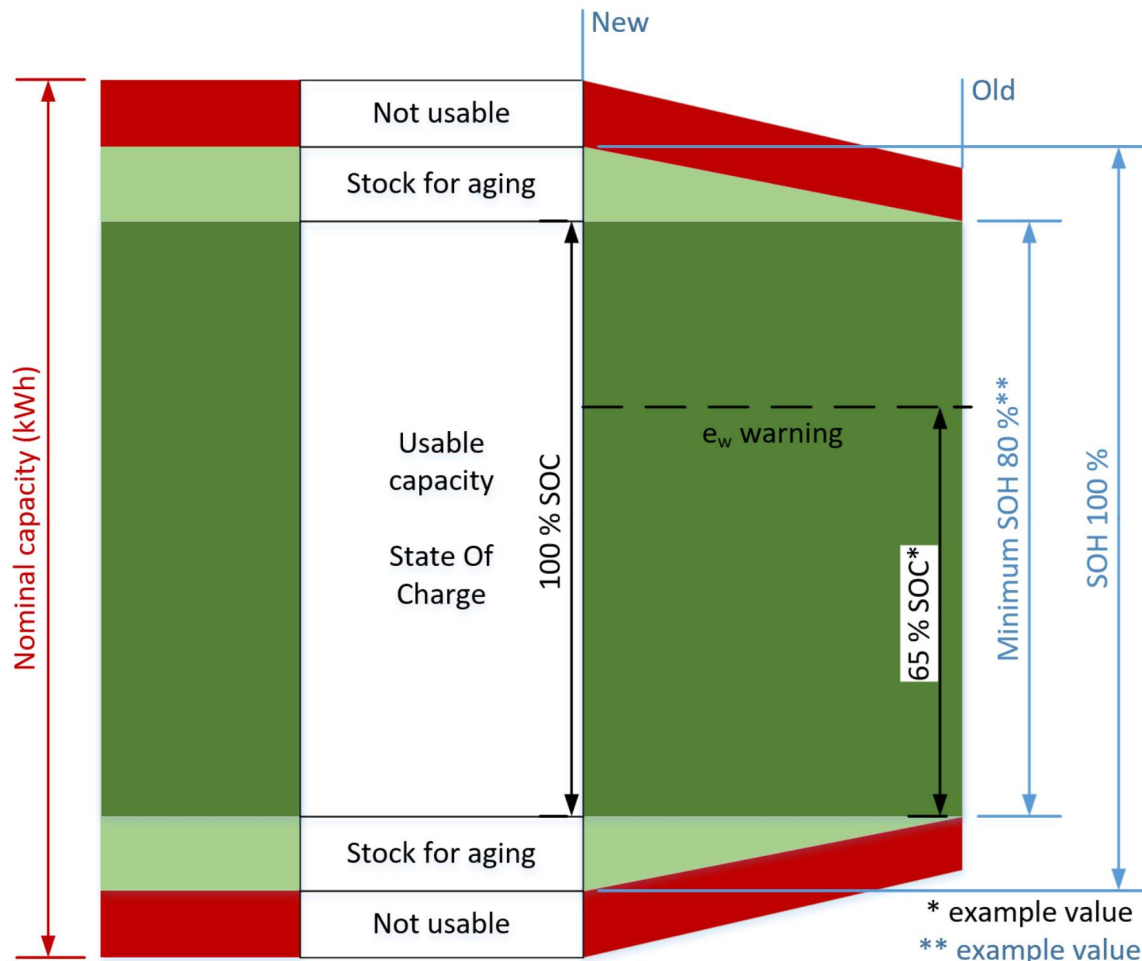

- Usable capacity taking battery ageing into account.
- SOC reference (100%) remains constant.
- Minimum SOH defines usable capacity.

Status and open topics still to be discussed

Comments and feedback collected until December 2020 have been captured and incorporated in the informal document distributed.

Recent comments and feedback collected during January 2021 will be reviewed during the next coming months in separate workshops.

Main topics to review and define further:

- The principles for PTI.
- Clarification to open questions related to Electrical Energy Storage devices vs. a Pneumatic Reservoir.