



Economic and Social Council

Distr.: General
28 August 2018

Original: English

Economic Commission for Europe

Inland Transport Committee

World Forum for Harmonization of Vehicle Regulations

176th session

Geneva, 13-16 November 2018

Item 4.12.2 of the provisional agenda

1958 Agreement:

**Consideration of proposals for new UN Regulations submitted
by the Working Parties subsidiary to the World Forum**

Proposal for a new UN Regulation on Road Illumination Devices (RID)

Submitted by the Working Party on Lighting and Light-Signalling*

The text reproduced below was adopted by the Working Party on Lighting and Light-Signalling (GRE) at its seventy-ninth session (ECE/TRANS/WP.29/GRE/79, para. 8). It is based on ECE/TRANS/WP.29/GRE/2018/3 and Annexes II, V and VIII to the report. The secretariat has also introduced some minor editorial corrections. The document is submitted to the World Forum for Harmonization of Vehicle Regulations (WP.29) and to the Administrative Committee AC.1 for consideration at their November 2018 sessions.

* In accordance with the programme of work of the Inland Transport Committee for 2018–2019 (ECE/TRANS/274, para. 123 and ECE/TRANS/2018/21/Add.1, cluster 3.1), the World Forum will develop, harmonize and update UN Regulations in order to enhance the performance of vehicles. The present document is submitted in conformity with that mandate.

UN Regulation on uniform provisions concerning the approval of road illumination devices (lamps) and systems for power-driven vehicles

Contents

	<i>Page</i>
1. Scope	3
2. Definitions.....	4
3. Administrative Provisions	4
4. General Technical Requirements	15
5. Specific Technical Requirements	26
6. Transitional provisions	58
 Annexes	
1 Communication	59
2 Minimum requirements for conformity of production control procedures.....	66
3 Minimum requirements for sampling by an inspector.....	71
4 Spherical coordinate measuring system and test point locations.....	74
5 Aiming procedure, instrumental verification of the "cut-off" for asymmetric passing-beams	86
6 Definition and sharpness of the horizontal "cut-off" line and aiming procedure by means of this "cut-off" line for symmetrical passing beam headlamps and front fog lamps	92
7 Tests for stability of photometric performance of Road Illumination Devices in operation (except cornering lamps)	95
Appendix 1 - Overview of operational periods concerning test for stability of photometric performance.....	104
Appendix 2 - Test mixture for dirty headlamp test.....	107
8 Requirements for road illumination devices (except cornering lamps) incorporating lenses of plastic material testing of lens or material samples	108
Appendix 1 - Chronological order of material tests	115
Appendix 2 - Method of measurement of the diffusion and transmission of light	117
Appendix 3 - Spray testing method	119
Appendix 4 - Adhesive tape adherence test.....	120
9 Requirements for LED modules and Road Illumination Devices (except cornering lamps) including LED modules.....	121
10 A general illustration for principal passing-beam and beam contributors and correlated light source options	125
11 Centre of reference	126
12 Voltage markings	127
13 Arrangement of approval marks.....	128
14 Description forms.....	131

Introduction

This Regulation combines the provisions of the individual UN Regulations Nos. 19, 98, 112, 113, 119 and 123 into a single regulation, and is the outcome of the WP.29 decision to simplify the UN lighting and light-signalling regulations based on the initial proposal by the European Union and Japan.

The objective of this Regulation is to increase the clarity, consolidate and streamline the complexity of requirements in UN Regulations Nos. 19, 98, 112, 113, 119 and 123 and prepare for the future transition to performance based requirements, by reducing the number of regulations through an editorial exercise without changing any of the detailed technical requirements already in force up to the date of entry into force of this Regulation.

Although this Regulation departs from the traditional approach of having a separate regulation for each device, by combining all road illumination devices into a single regulation, this simplified regulation contains all provisions and operates according to the existing structure of series of amendments, their transitional provisions and supplements. The transitional provisions associated with a new series of amendments of this Regulation will be identified for each device as applicable, this also includes a list of devices and their applicable change indexes relating to the series of amendments.

It is expected that all Contracting Parties to the 1958 Agreement will adopt this Regulation and shall provide detailed explanation in case they are not in a position to adopt particular devices. These decisions will be registered in ECE/TRANS/WP.29/343 that records the status of the annexed regulations and of the amendments.

Regarding the requirements for approval markings, this Regulation includes the requirements for the use of the "Unique Identifier" and is conditional upon access to the UN secure internet database (in accordance with Schedule 5 of the 1958 Agreement¹) where all type approval documentation is held. When the "Unique Identifier" is used there is no requirement for the devices to carry the conventional type approval markings (E-mark). If it is technically not possible to use the "Unique Identifier" (e.g. if the access to the UN internet database cannot be secured or the UN secure internet database is not operative) the use of conventional type approval markings is required until the use of the "Unique Identifier" is enabled.

1. Scope

This Regulation applies to the following road illumination devices:

Headlamps emitting a driving-beam and/or an asymmetrical passing-beam for vehicles of categories L, M, N and T

Adaptive front-lighting systems (AFS) for vehicles of categories M and N

Headlamps emitting a driving-beam and/or a symmetrical passing-beam for vehicles of categories L and T

Front fog lamps for vehicles of categories L3, L4, L5, L7, M, N and T

Cornering lamps for vehicles of categories M, N and T

¹ Agreement concerning the Adoption of Harmonized Technical United Nations Regulations for Wheeled Vehicles, Equipment and Parts which can be Fitted and/or be Used on Wheeled Vehicles and the Conditions for Reciprocal Recognition of Approvals Granted on the Basis of these United Nations Regulations (E/ECE/TRANS/505/Rev.3)

2. Definitions

For the purpose of this Regulation:

- 2.1. The definitions given in the latest series of amendments to UN Regulations Nos. 48 in force at the time of application for type approval shall apply, unless otherwise specified.
- 2.2. "Road illumination devices of different types" means road illumination devices which differ in such essential respects as:
 - 2.2.1. The trade name or mark:
 - (a) Lamps bearing the same trade name or mark but produced by different manufacturers shall be considered as being of different types;
 - (b) Lamps produced by the same manufacturer differing only by the trade name or mark shall be considered as being of the same type;
 - 2.2.2. The characteristics of the optical system;
 - 2.2.3. The inclusion or elimination of components capable of altering the optical effects by reflection, refraction, absorption and/or deformation during operation;
 - 2.2.4. Suitability for right-hand or left-hand traffic or for both traffic systems;
 - 2.2.5. For headlamps: the kind of beam produced (passing beam, driving beam or both);
 - 2.2.6. For AFS: the front-lighting function(s), mode(s) and classes produced;
 - 2.2.7. For AFS: the characteristic(s) of the signal(s), specified for the system;
 - 2.2.8. The category of light source(s) used and/or the LED module specific identification code(s);
 - 2.2.9. However, a device intended for the installation on the left side of the vehicle and the corresponding device intended for the installation on the right side of the vehicle shall be considered to be of the same type.

3. Administrative provisions

- 3.1. Application for approval
 - 3.1.1. The application for type approval shall be submitted by the holder of the trade name or mark or by his duly accredited representative.
 - 3.1.2. The application shall be accompanied by the following documents (in triplicate) and sample(s):
 - 3.1.2.1. drawings, sufficiently detailed to permit identification of the type and, if applicable, of the class of the lamp, showing:
 - (a) Geometrically in what position(s) the lamp(s) and/or the lighting units may be mounted on the vehicle in relation to ground and vehicle longitudinal median plane;
 - (b) The axis of observation to be taken as the axis of reference in the tests (horizontal angle $H = 0^\circ$, vertical angle $V = 0^\circ$) or in the case of lighting units showing each of them in vertical (axial) section and in

front elevation, with main details of the optical design including the axis/axes of reference; and the point to be taken as the centre of reference during the tests;

- (c) The limit of the apparent surface of the function(s);
- (d) The position and arrangement intended for the approval mark or the “Unique Identifier”;
- (e) In case of LED module(s) also the space reserved for the specific identification code(s) of the module(s);
- (f) A frontal view, with details of lens ribbing if any, and the cross section and any optical features, of the lens, if applicable;

3.1.3. A brief technical description stating in particular:

- (a) In the case of lamps with replaceable light sources, the category or categories of light source(s) prescribed; this light source category(s) shall be one of those contained in UN Regulations Nos. 37, 99 or 128
- (b) In the case of lamps with replaceable light source modules, the light source module specific identification code;
- (c) The make and type of supply and operating device(s), if any and if not being part of an installation unit;
- (d) If the device (lamp) is equipped with an adjustable reflector, the mounting position(s) of the lamp in relation to the ground and the longitudinal median plane of the vehicle;

3.1.3.1. In the case of a headlamp, it shall specify:

- (a) Whether the headlamp is intended to provide both a passing-beam and a driving-beam or only one of these beams;
- (b) If the headlamp is intended to provide a passing-beam, whether it is designed for both left-hand and right-hand traffic or for either left-hand or right-hand traffic only;
- (c) To which Class the headlamp belongs;
- (d) In the case of LED module(s) this shall include:
 - (i) A brief technical specification of the LED module(s);
 - (ii) A drawing with dimensions and the basic electrical and photometric values and the objective luminous flux and for each LED module a statement whether it is replaceable or not;
 - (iii) In case of electronic light source control gear, information on the electrical interface necessary for approval testing;

3.1.3.2. In the case of an AFS, it shall specify:

- (a) The lighting function(s) and their modes to be provided by the system;²
- (b) The lighting units contributing to each of them¹ and the signals³ with the technical characteristics relevant to their operation;

² To be indicated in a form conforming to the model of Annex 1.

- (c) Which categories¹ of the bending mode requirements apply, if any;
 - (d) Which additional data set(s) of Class E passing-beam provisions according to Table 14 of paragraph 5.3.2., if any;
 - (e) Which set(s) of Class W passing-beam provisions according to paragraph 5.3.2., if any;
 - (f) Which lighting units² provide or contribute to one or more passing-beam cut-off(s);
 - (g) The indication(s)¹ according to the provisions of paragraph 5.3.5.1. with respect to paragraph 6.22. of UN Regulation No. 48;
 - (h) Which lighting units are designed to provide the minimum passing-beam illumination according to paragraph 5.3.2.8.1.;
 - (i) Mounting and operation requirements for test purposes;
 - (j) Any other relevant information;
 - (k) In the case of LED module(s) this shall include:
 - (i) A brief technical specification of the LED module(s);
 - (ii) A drawing with dimensions and the basic electrical and photometric values and the objective luminous flux and for each LED module a statement whether it is replaceable or not;
 - (iii) In case of electronic light source control gear, information on the electrical interface necessary for approval testing;
 - (l) Any other front-lighting or front light signalling function(s), provided by any lamp(s) being grouped, combined or reciprocally incorporated to the lighting units of the system, for which approval is sought; sufficient information for identification of the respective lamp(s) and indication of the Regulation(s), according to which they are intended to be (separately) approved;
- 3.1.3.3. In the case of adaptation of the driving-beam, which lighting units² provide or contribute to the gradual adaptation of the driving-beam and of the sensor system along with the technical characteristics relevant to their operation.
- 3.1.3.3.1. The safety concept as laid down in the documentation, which, to the satisfaction of the Technical Service responsible for type approval tests:
- (a) Describe the measures designed into the system to ensure compliance with the provisions of paragraphs 4.11.2.1. and 5.3.2.5.4.; and
 - (b) Indicates the instructions for their verification according to paragraph 5.3.2.6.; and/or
 - (c) Gives access to the relevant documents demonstrating the system's performance concerning sufficient reliability and safe operation of the measures specified according to paragraph 3.1.3.3.1. a), e.g. FMEA ("Failure Mode and Effect Analysis"), FTA ("Fault Tree Analysis") or any similar process appropriate to system safety considerations.

³ To be indicated in a form conforming to the model of Annex 14.

- 3.1.3.4. If not otherwise specified, two complete samples, one sample intended for the installation on the left side of the vehicle and one sample intended for the installation of the right side of the vehicle.
- 3.1.3.5. For all lamps with plastic outer lenses, except for cornering lamps, samples of the plastic material of which the lenses are made (see Annex 8).
- 3.1.3.6. In the case of an AFS System, one set of samples of the system, for which approval is sought, including the mounting devices, supply and operating devices, and signal generators if any;
- 3.1.3.7. In the case of a type of lamp differing only by the trade name or mark from a type that has already been approved it is sufficient that the application is accompanied by:
- 3.1.3.7.1. A declaration by the lamp manufacturer that the type submitted is identical (except in the trade name or mark) with and has been produced by the same manufacturer as the type already approved, the latter being identified by its approval number;
- 3.1.3.7.2. Two samples bearing the new trade name or mark or equivalent documentation.
- 3.2. Approval
- 3.2.1. If the devices submitted for approval in pursuance of paragraph 3.1. meet the requirements of this Regulation approval shall be granted.
- 3.2.2. An approval number shall be assigned to each type approved and shall be marked on the device following the requirements of paragraph 3.3. The same Contracting Party shall not assign the same number to another type of device covered by this Regulation.
- 3.2.3. Notice of approval or of extension or refusal or withdrawal of approval of a type of a device pursuant to this Regulation shall be communicated to the Contracting Parties to the 1958 Agreement which apply this Regulation, by means of a form conforming to the model in Annex 1.
- 3.2.4. If approval is sought for an AFS which is not intended to be included as part of the approval of a vehicle type according to UN Regulation No. 48,
- 3.2.4.1. The applicant shall submit sufficient documentation to prove the capability of the system to comply with the provisions of paragraph 6.22. of UN Regulation No. 48 when correctly installed, and
- 3.2.4.2. The system shall be approved according to UN Regulation No. 10.
- 3.2.4.3. The symbols identifying the road illumination function for which type approval has been granted.

Table 1

List of symbols/combinations (full list is provided in Annex 1 “Communication”)

<i>Lamp (function)</i>	<i>Symbol</i>
Driving beam headlamp of Class A	R
Passing beam headlamp of Class A (asymmetrical)	C
Driving beam headlamp of Class B	HR
Passing beam headlamp of Class B (asymmetrical)	HC

<i>Lamp (function)</i>	<i>Symbol</i>
Driving beam headlamp of Class D (GDL)	DR
Passing beam headlamp of Class D (GDL asymmetrical)	DC
Adaptive Front lighting System (AFS): basic passing beam	XC ⁴
Adaptive Front lighting System (AFS): motorway passing beam	XCE ⁵
Adaptive Front lighting System (AFS): town passing beam	XCV ⁴
Adaptive Front lighting System (AFS): adverse weather passing beam	XCW ⁴
Adaptive Front lighting System (AFS): driving beam	XR ⁴
Passing beam headlamp of Class AS (symmetrical)	C-AS
Passing beam headlamp of Class BS (symmetrical)	C-BS
Passing beam headlamp of Class CS (symmetrical)	WC-CS
Passing beam headlamp of Class DS (symmetrical)	WC-DS
Passing beam headlamp of Class ES (GDL symmetrical)	WC-ES
Driving beam headlamp of Class BS	R-BS
Driving beam headlamp of Class CS	WR-CS
Driving beam headlamp of Class DS	WR-DS
Driving beam headlamp of Class ES (GDL)	WR-ES
Front fog lamp Class F3	F3
Cornering lamp	K

The minimum value for “a” in part 1 of Annex 13 shall be at least 5 mm for front fog lamps and cornering lamps and, for all other devices, at least 5 mm in case of with plastic lenses and at least 8 mm in case of glass lenses.

- 3.2.4.4. The applicable change indexes for each device relating to the series of amendments shall be as follows (see also paragraph 6.1.1.):

⁴ In the case of a single installation unit the symbol "XC" is marked only once.

⁵ In the case of more installation units each providing one or more AFS function(s) each unit is marked with the symbol "X" followed by the identification symbol(s) of the specific AFS function(s) provided.

Table 2
Series of amendments and change index

<i>Series of amendments to the Regulation</i>	<i>00</i>		
<i>Function (Lamp)</i>	<i>Change Index for the specific function (lamp)</i>		
Driving beam headlamp of Class A	0		
Passing beam headlamp of Class A (asymmetrical)	0		
Driving beam headlamp of Class B	0		
Passing beam headlamp of Class B (asymmetrical)	0		
Driving beam headlamp of Class D (GDL)	0		
Passing beam headlamp of Class D (GDL asymmetrical)	0		
Adaptive Front lighting System (AFS): basic passing beam	0		
Adaptive Front lighting System (AFS): motorway passing beam	0		
Adaptive Front lighting System (AFS): town passing beam	0		
Adaptive Front lighting System (AFS): adverse weather passing beam	0		
Adaptive Front lighting System (AFS): driving beam	0		
Passing beam headlamp of Class AS (symmetrical)	0		
Passing beam headlamp of Class BS (symmetrical)	0		
Passing beam headlamp of Class CS (symmetrical)	0		
Passing beam headlamp of Class DS (symmetrical)	0		
Passing beam headlamp of Class ES (GDL symmetrical)	0		
Driving beam headlamp of Class BS	0		
Driving beam headlamp of Class CS	0		
Driving beam headlamp of Class DS	0		
Driving beam headlamp of Class ES (GDL)	0		
Front fog lamp Class F3	0		
Cornering lamp	0		

- 3.3. Approval mark
- 3.3.1. General provisions
- 3.3.1.1. Every device belonging to an approved type shall comprise a space of sufficient size for the Unique Identifier (UI) as referred to in the 1958 Agreement and other markings as defined in paragraph 3.3.2.6. or, if technically not possible, the approval marking with the additional symbols and other markings as defined in paragraph 3.3.2. respectively.
- 3.3.1.2. Examples of the arrangement of the markings are shown in Annex 13.
- 3.3.1.3. The space for the UI or the approval mark shall be shown in the drawings mentioned in paragraph 3.1.2.
- 3.3.1.4. The UI or the approval mark with the additional symbols, shall be clearly legible and indelible. It may be placed on an inner or outer part (transparent or not) of the lamp which cannot be separated from the transparent part of the lamp emitting the light. In any case the marking shall be visible when the lamp is fitted on the vehicle or when a movable part such as the hood or boot lid or a door is opened.
- 3.3.1.5. In the case of grouped, combined or reciprocally incorporated lamps a single UI or approval mark may be applied, provided that all the grouped, combined or reciprocally incorporated lamps satisfy the pertinent Regulation and that the following requirements are also fulfilled:
- (a) Requirements of paragraph 3.3.2. apply;
 - (b) No part of the grouped, combined or reciprocally incorporated lamps that transmits light can be removed without at the same time removing the approval mark;
 - (c) The symbols for each lamp, appropriate to each Regulation under which approval has been granted, shall be marked:
 - (i) Either on the appropriate light-emitting surface;
 - (ii) Or in a group, in such a way that each lamp of the grouped, combined or reciprocally incorporated lamps may be clearly identified;
 - (d) The size of the components of a single approval mark shall not be less than the minimum size required for the smallest of the individual marks by the pertinent Regulation.
- 3.3.1.6. In the case of different types of lamps complying with the requirements of several Regulations, which use the same outer lens having the same or different colour, a single approval mark may be used provided that:
- (a) The symbols for each lamp, appropriate to each Regulation under which approval has been granted, are marked in conformity to paragraph 3.3.2.;
 - (b) The main body of the lamp shall bear the approval mark of the actual function(s);
 - (c) The size of the components of a single approval mark shall not be less than the minimum size required for the smallest of the individual marks by the pertinent Regulation.
- 3.3.1.7. In the case of lamps grouped, combined or reciprocally incorporated with other lamps the lens of which may also be used for other types of lamps the provisions of paragraph 3.3. apply.

- 3.3.2. The approval marking shall consist of:
- 3.3.2.1. A circle surrounding the letter "E" followed by the distinguishing number of the country which has granted approval.⁶
- 3.3.2.2. The approval number prescribed in paragraph 3.2.2.
- 3.3.2.3. The number of this Regulation followed by the letter 'R' and the two digits indicating the series of amendments in force at the time of issue of the approval.
- 3.3.2.4. Additional symbols for headlamps, AFS and front fog lamps:
- 3.3.2.4.1. In the case of headlamps/AFS installation unit meeting left-hand traffic requirements only, a horizontal arrow pointing to the right of an observer facing the headlamp, i.e. to the side of the road on which the traffic moves;
- 3.3.2.4.2. In the case of headlamps/AFS installation unit designed to meet the requirements of both traffic systems by means of an appropriate adjustment of the setting of the optical unit or the light source(s) or LED module(s), a horizontal arrow with a head on each end, the heads pointing respectively to the left and to the right;
- 3.3.2.4.3. Front fog lamps of Class F3 having asymmetric light distribution and which must not be indiscriminately mounted on either side of the vehicle, shall bear an arrow pointing to the outside of the vehicle;
- 3.3.2.4.4. In the case of front fog lamps, headlamps and AFS installation unit incorporating a lens of plastic material, the group of letters "PL" to be affixed near the symbols identifying the lighting;
- 3.3.2.4.5. In the case of headlamps/AFS installation unit meeting the requirements of the driving-beam, an indication, placed near the circle surrounding the letter "E", of the maximum luminous intensity expressed by a reference mark (I_M), as defined in paragraph 5.1.3.6.
In the case of grouped or reciprocally incorporated driving-beam headlamps/AFS lighting unit, indication of the maximum luminous intensity of the driving-beams as a whole shall be expressed as above.
- 3.3.2.4.6. In the case of headlamps/AFS installation unit so designed that the light source(s) or LED module(s) producing the principal passing-beam shall not be lit simultaneously with that of any other lighting function with which it may be reciprocally incorporated: an oblique stroke (/) shall be placed behind the symbol indicating the headlamp producing the passing beam in the approval mark.
- 3.3.2.4.6.1. This requirement shall not apply to headlamps meeting the requirements of Class D headlamps which are so designed that the passing beam and the driving beam are provided by the same gas-discharge light source.
- 3.3.2.4.7. In the case of AFS, a score above the letter(s) indicates that the AFS function(s) is(are) provided by more than one installation unit on that side of the system.

⁶ The distinguishing numbers of the Contracting Parties to the 1958 Agreement are reproduced in Annex 3 to the Consolidated Resolution on the Construction of Vehicles (R.E.3) (ECE/TRANS/WP.29/78/Rev.6).

- 3.3.2.5. The approval number and the symbols shall be placed close to the circle and either above or below the letter “E”, or to the right or left of that letter. The digits of the approval number shall be on the same side of the letter “E” and face the same direction.
- 3.3.2.6. Other markings
- Road illumination functions or systems shall bear, in indelible and clearly legible manner, the trade name or mark of the applicant and the following markings:
- 3.3.2.6.1. In the case of devices including a passing beam designed to satisfy the requirements both of right-hand and of left-hand traffic, markings indicating the two settings of the optical unit on the vehicle or of the light source on the reflector; these markings shall consist of the letters "R/D" for the position for right-hand traffic and the letters "L/G" for the position for left-hand traffic;
- 3.3.2.6.2. In the case of lamps with replaceable light source(s) or with replaceable light source modules, a marking indicating:
- (a) The category or categories of light source(s) prescribed for headlamps of Classes AS, BS, CS, DS, ES and cornering lamps; and/or
 - (b) The light source module specific identification code; and /or
 - (c) The rated voltage(s), the rated wattage(s) and specific identification code of LED module(s) for headlamps, front fog lamps and AFS;
- 3.3.2.6.3. In the case of lamps with light source module(s), a marking on the light source module(s) indicating:
- (a) The trade name or mark of the applicant;
 - (b) The specific identification code of the module. This specific identification code shall comprise the starting letters “MD” for “MODULE” followed by the approval mark without the circle as prescribed in paragraph 3.3.2.1.; this identification code shall be shown in the drawings mentioned in paragraph 3.1.2. The approval mark does not have to be the same as the one on the lamp in which the module is used, but both marks shall be from the same applicant;
 - (c) In case of cornering lamps, the rated voltage or the range of voltage.
- In the case where the light-source module(s) is non-replaceable, it does not need to be marked.
- 3.3.2.6.4. In the case of cornering lamps with:
- (a) An electronic light source control gear; or
 - (b) Non-replaceable light sources; and/or
 - (c) Light source module(s);
- marking of the rated voltage or range of voltage;
- 3.3.2.6.5. On an electronic light source control gear:
- 3.3.2.6.5.1. In case of headlamps, AFS systems and front fog lamps:
- If an electronic light source control gear which is not part of a LED module is used to operate a LED module(s), it shall be marked with its specific identification code(s), the rated input voltage and wattage.

- 3.3.2.6.5.2. In case of cornering lamps:
An electronic light source control gear being part of the lamp but not included into the lamp body shall bear the name of the manufacturer and its identification number.
- 3.3.2.6.6. In the case of AFS, front fog lamps and headlamps except Class AS, BS, CS, DS and ES meeting the requirements of Annex 7 only when supplied with a voltage of 12V, a marking consisting of the Number 24 crossed out by an oblique cross (X) near the holders of the light source(s);
- 3.3.2.6.7. In the case of a headlamp having additional lighting unit(s) for vehicles of categories L and T:
- 3.3.2.6.7.1. The headlamps producing the principal passing beam shall bear specific identification code of the additional lighting unit(s) mentioned in paragraph 3.3.2.6.7.2.2.
- 3.3.2.6.7.2. Additional lighting unit(s) shall bear the trade name or mark of the applicant and the following markings:
- 3.3.2.6.7.2.1. In the case of light source(s), their category(ies), and/or
In the case of LED module(s), the rated voltage and rated wattage and the specific identification code(s) of the LED module(s).
- 3.3.2.6.7.2.2. The specific identification code(s) of the additional lighting unit(s). This marking shall be clearly legible and indelible.
This specific identification code shall be comprised of starting letters "ALU" for "Additional Lighting Unit" followed by approval marking without the circle and in the case where several non-identical additional lighting units are used, additional symbols or characters shall follow. This specific identification code shall be shown in the drawings. The approval marking does not have to be the same as the one on the lamp in which the additional lighting unit(s) is used, but both markings shall be from the same applicant.
- 3.3.3. The approval marking may be replaced by the Unique Identifier (UI), if available. The Unique Identifier mark shall follow the format in the example shown below:

Figure I
Unique Identifier (UI)

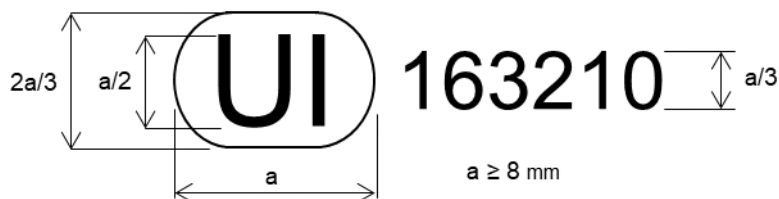

The above Unique Identifier (UI) marked on the lamp shows that the type concerned has been approved and that the relevant information on that type approval can be accessed on the UN secure internet database by using 163210 as the Unique Identifier.

- 3.4. Modifications of a road illumination device and extension of approval
- 3.4.1. Every modification of a type of lamp shall be notified to the Type Approval Authority which approved the type. The Authority may then either:

- 3.4.1.1. Consider that the modifications made are unlikely to have an appreciable adverse effect and that in any case the lamp still complies with the requirements; or
- 3.4.1.2. Require a further test report from the technical service responsible for conducting the tests.
- 3.4.2. Confirmation or refusal of approval, specifying the alterations, shall be communicated by the procedure specified in paragraph 3.2.3. to the Contracting Parties to the 1958 Agreement applying this Regulation.
- 3.4.3. The Type Approval Authority issuing the extension of approval shall assign a series number for such an extension and inform thereof the other Contracting Parties to the 1958 Agreement applying this Regulation under which the approval has been granted by means of a communication form conforming to the model in Annex 1 to this Regulation.
- 3.5. Conformity of production

The conformity of production procedures shall comply with those set out in the 1958 Agreement, Schedule 1 (E/ECE/TRANS/505/Rev.3), with the following requirements:
- 3.5.1. Road illumination devices approved under this Regulation shall be so manufactured as to conform to the type approved by meeting the requirements set forth in paragraphs 4.16. and 5.
- 3.5.1.1. The minimum requirements for conformity of production control procedures set forth in Annex 2 shall be complied with;
- 3.5.1.2. The minimum requirements for sampling by an inspector set forth in Annex 3 shall be complied with;
- 3.5.2. The Type Approval Authority which has granted type approval may at any time verify the conformity control methods applied in each production facility. The normal frequency of these verifications shall be once every two years.
- 3.5.3. For devices in accordance with paragraph 5.6. only (Cornering Lamps) and in the case of non-replaceable filament light source(s) or light source module(s) equipped with non-replaceable filament light source(s), the applicant shall annex to the type approval documentation a report (by the light source manufacturer indicated in the type approval documentation), acceptable to the Authority responsible for type approval that demonstrates compliance of these non-replaceable filament light source with the requirements as specified in paragraph 4.11 of IEC 60809, Edition 3.
- 3.5.4. Road illumination devices with apparent defects are disregarded.
- 3.5.5. The reference mark is disregarded.
- 3.5.6. The measuring points in Table 8 Part B are disregarded.
- 3.5.7. The measuring points 8 to 15 in Table 35 are disregarded.
- 3.6. Penalties for non-conformity of production
- 3.6.1. The approval granted in respect of a device pursuant to this Regulation may be withdrawn if the foregoing requirements are not met;
- 3.6.2. If a Contracting Party to the Agreement which applies this Regulation withdraws an approval it has previously granted, it shall forthwith so notify

the other Contracting Parties applying this Regulation, by means of a communication form conforming to the model in Annex 1.

3.7. Production definitively discontinued

If the holder of the approval completely ceases to manufacture a device approved in accordance with this Regulation, he shall so inform the authority which granted the approval. Upon receiving the relevant communication, that authority shall inform thereof the other Contracting Parties to the 1958 Agreement applying this Regulation by means of a communication form conforming to the model in Annex 1.

3.8. Names and addresses of Technical Services responsible for conducting approval tests, and of Type Approval Authorities

The Contracting Parties to the 1958 Agreement which apply a UN Regulation shall communicate to the United Nations Secretariat the names and addresses of the Technical Services responsible for conducting approval tests and of the Type Approval Authorities which grant approval and to which forms certifying approval or extension or refusal or withdrawal of approval, or the definitive discontinuation of production issued in other countries, are to be sent.

4. General technical requirements

Lamps submitted for approval shall conform to the requirements set forth in paragraphs 4 and 5.

The requirements contained in sections 5 "General specifications" and 6 "Individual specifications" (and in the Annexes referenced in the said sections) of UN Regulations No. 48, 53, 74 or 86, and their series of amendments in force at the time of application for the lamp type approval shall apply to this Regulation.

The requirements pertinent to each lamp and to the category/ies of vehicle on which the lamp is intended to be installed shall be applied, where its verification at the moment of lamp type approval is feasible.

4.1. The lamps must be so designed and constructed that under normal conditions of use and notwithstanding the vibrations to which they may be subjected in such use, their satisfactory operation remains assured and they retain the characteristics prescribed by this Regulation.

4.2. Lamps shall be so made that they give adequate illumination without dazzle when emitting the passing-beam, and good illumination when emitting the driving-beam. Bend lighting may be produced by activating one additional filament light source, one or more additional LED light source(s), or one or more additional LED module(s) being part of a lamp producing a passing beam.

4.3. Lamps shall be fitted with a device enabling them to be so adjusted on the vehicles as to comply with the rules applicable to them. In case of the headlamps of classes AS, BS, CS, DS and ES, such a device may or may not provide horizontal adjustment, provided that the headlamps are so designed that they can maintain a proper horizontal aiming even after the vertical aiming adjustment. Such a device need not be fitted on units in which the reflector and the diffusing lens cannot be separated, provided the use of such

units is confined to vehicles on which the lamp setting can be adjusted by other means.

- 4.4. Where a lamp producing a principal passing-beam and a lamp producing a driving-beam, each equipped with its own light source(s) or LED module(s), the adjusting device shall enable the principal passing-beam and the driving-beam to be adjusted individually.

However, these provisions shall not apply to assemblies whose reflectors are indivisible.

- 4.5. Light sources

- 4.5.1. Restrictions on light sources

- 4.5.1.1. The lamp shall only be equipped with light source(s) approved according to UN Regulations Nos. 37, 99 and/or 128, provided that no restriction on the use is made in UN Regulation No. 37 and its series of amendments in force at the time of application for type approval or in UN Regulation No. 99 and its series of amendments in force at the time of application for type approval or in UN Regulation No. 128 and its series of amendments in force at the time of application for type approval, and/or LED module(s), and/or light source module(s) (for cornering lamps only) and/or non-replaceable light source(for cornering lamps only).

- 4.5.1.2. Front fog lamps, irrespective of whether the light sources can be replaced or not, shall only be equipped with one or more light sources approved according to:

- (a) UN Regulation No. 37, or
- (b) UN Regulation No. 99, or
- (c) UN Regulation No. 128,

And/or, one or more LED modules where the requirements of Annex 9 shall apply; compliance with these requirements shall be tested.

- 4.5.1.3. Headlamps of class D shall only be equipped with:

- 4.5.1.3.1. In case of the principal passing beam, one gas-discharge light source. A maximum of two additional light sources are permitted for the passing beam as follows:

- (a) One additional filament light source approved according to UN Regulation No. 37, one or more additional LED light source(s) approved according to UN Regulation No. 128 or one or more additional LED module(s) may be used inside the passing beam headlamp to contribute to bend lighting.
- (b) One additional filament light source approved according to UN Regulation No. 37, one or more additional LED light source(s) approved according to UN Regulation No. 128 and/or one or more LED module(s) inside the passing beam headlamp, may be used for the purposes of generating infrared radiation. It/they shall only be activated at the same time as the gas discharge light source. In the event that the gas-discharge light source fails, this additional filament light source, LED light source(s) and/or LED module(s) shall be automatically switched off.

In the event of failure of an additional filament or LED light source or LED module, the headlamp shall continue to fulfil the requirements of the passing beam.

- 4.5.1.3.2. In case of the driving beam, one or more filament light sources approved according to UN Regulation No. 37, one or more gas-discharged light source approved according to UN Regulation No. 99, one or more LED light sources approved according to UN Regulation No. 128 and/or LED module(s). Where more than one light source is used to provide the driving beam, these light sources shall be operated simultaneously.

It is also possible that a part of the driving beam produced by one of these light sources will be used exclusively for short time signals (flash to pass) as declared by the applicant. This shall be indicated in the relevant drawing and a remark shall be made in the communication form.

- 4.5.1.4. Headlamps of classes A and B shall only be equipped with:

- 4.5.1.4.1. In case of the principal passing beam, one filament light source approved according to UN Regulation No. 37, one or more LED light source(s) approved according to UN Regulation No. 128 or one or more LED module(s). Additional light sources are permitted for the passing beam as follows:

- (a) One additional filament light source approved according to UN Regulation No. 37, one or more additional LED light source(s) approved according to UN Regulation No. 128, or one or more additional LED module(s) may be used inside the passing beam headlamp to contribute to bend lighting.
- (b) One additional filament light source approved according to Regulation No. 37, one or more additional LED light source(s) approved according to UN Regulation No. 128 and/or one or more LED module(s), inside the passing beam headlamp, may be used for the purposes of generating infrared radiation. It/they shall only be activated at the same time as the principal passing beam. In the event that the principal light beam fails, this/these additional light source(s) and/or LED module(s) shall be automatically switched off.

In the event of failure of an additional filament light source, one of more additional LED light source(s) or one or more additional LED module(s), the headlamp shall continue to fulfil the requirements of the passing beam.

- 4.5.1.4.2. In case of the driving beam, irrespective of the type of light source (LED module(s) or filament or LED light source(s)) used to produce the principal passing-beam, one or more filament light sources approved according to UN Regulation No. 37, one or more LED light source(s) approved according to UN Regulation No. 128 or one or more LED module(s).

- 4.5.1.5. Headlamps of classes AS, BS, CS, DS shall only be equipped with:

- 4.5.1.5.1. In case of the principal passing beam, one or two filament light sources approved according to UN Regulation No. 37, one or more LED light source(s) approved according to UN Regulation No. 128 and/or one or more LED module(s). In the case of the use of additional light source(s) and/or additional lighting unit(s) to provide bend lighting, only filament light sources approved according to UN Regulation No. 37, LED light sources

approved according to UN Regulation No. 128 and/or LED modules(s) shall be used.

4.5.1.5.2. In case of the driving beam, irrespective of the type of light source (LED module(s) or filament or LED light source(s)) used to produce the principal passing-beam, one or more filament light sources approved according to UN Regulation No. 37, one or more LED light sources approved according to UN Regulation No. 128 or one or more LED module(s).

4.5.1.6. Headlamps of class ES shall only be equipped with:

4.5.1.6.1. In case of the principal passing beam, one gas-discharge light source approved according to UN Regulation No. 99, one or more LED light source(s) approved according to UN Regulation No. 128 or one or more LED module(s). In the case of the use of additional light source(s) and/or additional lighting unit(s) to provide bend lighting, only filament light sources approved according to UN Regulation No. 37, LED light sources approved according to UN Regulation No. 128 and/or LED modules(s) shall be used.

4.5.1.6.2. In case of the driving beam, irrespective of the type of light source (LED module(s) or gas-discharge or LED light source(s)) used to produce the principal passing-beam, one or more gas-discharged light sources approved according to UN Regulation No. 99, one or more LED light sources approved according to UN Regulation No. 128 or one or more LED module(s).

4.5.1.7. Cornering lamps shall only be equipped with one or a combination of:

- (a) Filament light sources approved according to UN Regulation No. 37;
- (b) LED light sources approved according to UN Regulation No. 128;
- (c) LED module(s);
- (d) Light Source module(s);
- (e) Non-replaceable light source.

4.5.1.8. AFS of classes C, E, V, W, R shall only be equipped with one or a combination of:

- (a) Filament light sources approved according to UN Regulation No. 37;
- (b) Gas-discharge light sources approved according to UN Regulation No. 99;
- (c) LED light sources approved according to UN Regulation No. 128;
- (d) LED module(s).

However, the class C (basic) passing beam shall be equipped only with replaceable light sources or replaceable or non-replaceable LED modules.

4.5.2. General requirements for light sources

4.5.2.1. In case a light source category or categories or type(s) is restricted for use in lamps on vehicles in use and originally equipped with such lamps, the applicant for type approval of the lamp shall declare that the lamp is only intended for installation on those vehicles; this shall be noted in the communication form

- 4.5.2.2. In case of replaceable light source(s),
- (a) The design of the lamp shall be such that the light source(s) can be fixed in no other position but the correct one;
 - (b) The light source(s) holder shall conform to the characteristics given in IEC Publication 60061. The holder data sheet relevant to the category of light source(s) used, applies.
- 4.5.2.3. Electronic light source control gear(s), if applicable, shall be considered to be part of the lamp; they may be part of the LED module(s).
- 4.5.2.4. The headlamp of class D and/or class ES and its ballast system or light source control gear shall not generate radiated or power line disturbances, which cause a malfunction of other electric/electronic systems of the vehicle.⁷
- 4.5.2.5. Front fog lamps, designed to operate permanently with an additional system to control the intensity of the light emitted, or which are reciprocally incorporated with another function, using a common light source, and designed to operate permanently with an additional system to control the intensity of the light emitted, are permitted.
- 4.5.2.6. Except for AFS and cornering lamps, in case of a lamp incorporating one or more light source(s) or LED module(s) producing the principal passing-beam or the front fog beam and having a total objective luminous flux which exceeds 2,000 lumens, a reference shall be made in the communication form in Annex 1.
- In case of an AFS incorporating light sources and/or LED module(s) producing the basic passing beam and having a total objective luminous flux of the lighting units as indicated under item 9.3.2.3. of the communication form which exceeds 2,000 lumen per side, a reference shall be made in the communication form in Annex 1.
- The objective luminous flux of LED modules shall be measured as described in paragraph 5. of Annex 9.
- 4.5.2.7. A LED module shall be:
- (a) Only removable from its device with the use of tools, unless it is stated in the communication sheet that the LED module is non-replaceable; and
 - (b) So designed that regardless of the use of tool(s), it is not mechanically interchangeable with any replaceable approved light source.
- 4.5.3. Specific requirements for light sources
- 4.5.3.1. In case of cornering lamps equipped with light source module(s), the design of the light source module(s) shall be such as:
- (a) That each light source module(s) can only be fitted in no other position than the designated and correct one and can only be removed with the use of tool(s);

⁷ Compliance with the requirements for electromagnetic compatibility is relevant to the vehicle type.

- (b) If there are more than one light source module(s) used in the housing for a device, light source module(s) having different characteristics cannot be interchanged within the same lamp housing;
 - (c) The light source module(s) shall be tamperproof;
 - (d) A light source module(s) shall be so designed that regardless of the use of tool(s), it shall not be mechanically interchangeable with any replaceable approved light source.
- 4.5.3.2. For headlamps, AFS and front fog lamp equipped with LED light source(s) and/or LED module(s):
- 4.5.3.2.1. Electronic light source control gear(s) associated with the operation of LED module(s), if applicable, shall be considered to be part of the lamp; they may be part of the LED module(s).
- 4.5.3.2.2. The lamp and the LED module(s) themselves shall comply with the relevant requirements specified in Annex 9 to this Regulation. The compliance with the requirements shall be tested.
- 4.5.3.2.3. In case of the headlamp of classes A, B, D and AFS, the total objective luminous flux of all LED light sources and/or LED modules producing the principal passing beam and measured as described in paragraph 5. of Annex 9 (LED modules only) shall be equal or greater than 1,000 lumens.
- 4.5.3.2.4. In case of the headlamp of classes AS, BS, CS and DS, the total objective luminous flux of all LED light sources and/or LED modules producing the principal passing beam and measured as described in paragraph 5. of Annex 9 (LED modules only) shall be within the following limits.

Table 3

“Classes AS, BS, CS and DS - Passing beam minimum and maximum limits for luminous flux”

	<i>Headlamps Class AS</i>	<i>Headlamps Class BS</i>	<i>Headlamps Class CS</i>	<i>Headlamps Class DS</i>
Passing beam minimum	150 lumen	350 lumen	500 lumen	1,000 lumen
Passing beam maximum	900 lumen	1,000 lumen	2,000 lumen	2,000 lumen

- 4.5.3.2.5. In case of headlamps of class ES, the total objective luminous flux of all LED light sources and/or LED modules producing the principal passing beam and measured as described in paragraph 5. of Annex 9 shall be within the following limits:

Table 4

“Class ES - Passing beam minimum limit for luminous flux”

	<i>Headlamps Class ES</i>
Passing beam minimum	2,000 lumen

- 4.5.3.2.6. In the case of a replaceable LED module the removal and replacement of this LED module, as described in Annex 9, paragraph 1.4.1. shall be demonstrated to the satisfaction of the Technical Service.
- 4.5.3.2.7. UN Regulation No. 48 defines that LED modules may contain holders for other light sources.

- 4.5.3.3. In case of headlamps of classes AS, BS, CS and DS, the reference luminous flux at 13.2 V of each filament light source for the principal passing beam does not exceed 900 lm for classes AS and BS and 2,000 lm for classes CS and DS.
- 4.6. Testing of the lamp
- Depending on the light source used, the following conditions shall apply.
- 4.6.1. In the case of replaceable filament light sources:
- 4.6.1.1. In the case of filament light sources operating directly under vehicle voltage system conditions:
- The lamp shall be checked by means of colourless standard (étalon) filament light sources as specified in UN Regulation No. 37.
- During the testing of the lamp, except for cornering lamps, the power supply to the filament light source(s) shall be regulated so as to obtain the reference luminous flux at 13.2 V as indicated on the relevant data sheet of UN Regulation No. 37.
- During the testing of cornering lamps, the power supply to the filament light source(s) shall be regulated so as to obtain the reference luminous flux at 13.2 V or 13.5 V as indicated on the relevant data sheet of UN Regulation No. 37.
- However, if a filament light source of category H9 or H9B is used for the principal passing-beam, the applicant may choose the reference luminous flux at 12.2 V or 13.2 V as indicated in the relevant data sheet of UN Regulation No. 37 and a reference stating which voltage was chosen for type approval shall be made in item 9 in the communication form of Annex 1.
- 4.6.1.2. In order to protect the standard (étalon) filament light source during the process of photometric measurement it is permissible to carry out the measurements at a luminous flux that differs from the reference luminous flux at 13.2 V. If the Technical Service chooses to carry out measurements in such a manner, the luminous intensity shall be corrected by multiplying the measured value by the individual factor F_{lamp} of the standard (étalon) filament light source in order to verify the compliance with the photometric requirements where:
- $$F_{\text{lamp}} = \Phi_{\text{reference}} / \Phi_{\text{test}}$$
- $\Phi_{\text{reference}}$ is the reference luminous flux at 13,2 V as specified in the relevant data sheet of UN Regulation No. 37
- Φ_{test} is the actual luminous flux used for the measurement.
- However, where the reference luminous flux of 12.2 V as specified in the data sheet for the category H9 or H9B is chosen, this procedure is not permitted.
- 4.6.2. In the case of a gas-discharge light source:
- A standard light source shall be used as specified in UN Regulation No. 99, which has been aged during at least 15 cycles, in accordance with paragraph 4. of Annex 4 to UN Regulation No. 99.
- During testing of the lamp the voltage at the terminals of the ballast or at the terminals of the light source in case the ballast is integrated with the light

source shall be regulated to maintain 13.2 V for a 12 V system, or at the vehicle voltage as specified by the applicant, with a tolerance of ± 0.1 V.

The objective luminous flux of the gas-discharge light source may differ from that specified in UN Regulation No. 99. In this case, the luminous intensity values shall be corrected accordingly.

4.6.3. In the case of replaceable LED light sources:

The lamp shall be checked by means of a standard light source as specified in UN Regulation No. 128.

During testing of the lamp, the voltage supplied to the light source(s) shall be regulated to maintain 13.2 V or 13.5 V (optionally for cornering lamps only) for a 12 V system or 28 V for a 24 V system, or at the vehicle voltage as specified by the applicant, with a tolerance of ± 0.1 V.

The luminous intensity values produced shall be corrected. The correction factor is the ratio between the objective luminous flux and the value of the luminous flux found at the voltage applied. In the case of more than one LED light source, the mean value of the correction factors shall be applied, while each individual correction factor shall not deviate more than 5 per cent from this mean value.

4.6.4. In the case of LED modules:

All measurements on lamps equipped with LED module(s) shall be made at 6.3 V, 13.2 V or 28.0 V respectively, if not otherwise specified within this Regulation. LED modules operated by an electronic light source control gear shall be measured with the input voltage as specified by the applicant or with a supply and operating device which replace this control gear for the photometric test.

4.6.5. In the case of non-replaceable light sources, only, if allowed according to the requirements of paragraph 4:

All measurements on lamps equipped with non-replaceable light sources shall be made at 6.3 V or 6.75 V (optionally for cornering lamps only), 13.2 V or 13.5 V (optionally for cornering lamps only) or 28.0 V or at other vehicle voltage as specified by the applicant. The test laboratory may require from the applicant the special power supply needed to supply the light sources. The test voltages shall be applied to the input terminals of the lamp.

4.6.6. In the case of a lamp that uses a light source control gear being part of the lamp, the voltage declared by the applicant shall be applied to the input terminals of that lamp.

4.6.7. In the case of a lamp that uses a light source control gear not being part of the lamp the voltage declared by the applicant shall be applied to the input terminals of that light source control gear. The test laboratory shall require from the applicant the special light source control gear needed to supply the light source and the applicable functions. The identification of that light source control gear if applicable and/or the voltage applied, including the tolerances, shall be noted in the communication form in Annex 1.

4.6.8. In the case of headlamps or AFS equipped with different kinds of light sources, the part of the lamp equipped:

- (a) With replaceable filament light sources shall be tested according to paragraph 4.6.1.;

- (b) With a gas-discharge light source shall be tested according to paragraph 4.6.2.;
- (c) With replaceable LED light sources shall be tested according to paragraph 4.6.3.;
- (d) With LED modules shall be tested according to paragraph 4.6.4.

and then added to the previous result obtained from the light sources tested.

- 4.7. Testing of light transmitting components made of plastic material (except for cornering lamps and headlamps of classes AS).
- 4.7.1. If the outer lens of the lamp is made of plastic material tests shall be done according to the requirements in Annex 8.
- 4.7.2. The UV resistance of light transmitting components located inside a front fog lamp and made of plastic material shall be tested according to Annex 8, paragraph 3.4.
- 4.7.2.1. The test prescribed in paragraph 4.7.2. is not necessary if low-UV type light sources as specified either in the relevant UN Regulation or in Annex 9 are used, or if provisions are taken, to shield the relevant lamp components from UV radiation, e.g. by glass filters.
- 4.8. The sharpness and linearity of the cut-off, if applicable, shall be tested according to the requirements in Annex 5 or 6 respectively.
- 4.9. Except for cornering lamps, complementary tests shall be done according to the requirements in Annex 7 to ensure that in use there is no excessive change in photometric performance.
- 4.10. Lamps with asymmetrical "cut-off" line designed to satisfy the requirements both of right hand and of left hand traffic may be adapted for traffic on a given side of the road either by an appropriate initial setting when fitted on the vehicle or by selective setting by the user. Such initial or selective setting may consist, for example, of fixing either the optical unit at a given angle on the vehicle or the light source(s) producing the principal passing-beam at a given angle/position in relation to the optical unit.

In all cases, only two different and clearly distinct settings, one for right hand and one for left-hand traffic, shall be possible, and the design shall preclude inadvertent shifting from one setting to the other or setting in an intermediate position.

Where two different setting positions are provided for the light source(s) producing the principal passing-beam, the components for attaching this light source(s) to the reflector must be so designed and made so that, in each of its two settings, this light source(s) will be held in position with the precision required for headlamps designed for traffic on only one side of the road.

Conformity with the requirements of this paragraph shall be verified by visual inspection and, where necessary, by a test fitting.

- 4.11. Testing of mechanical or electromechanical structures
- 4.11.1. On headlamps or a system designed to provide alternately a driving-beam and a passing-beam, or a passing-beam and/or a driving-beam designed to become bend lighting, any mechanical, electromechanical or other device incorporated in the headlamp and lighting unit(s) for these purposes shall be so constructed that:

- 4.11.1.1. The device is robust enough to withstand 50,000 operations under normal conditions of use. In order to verify compliance with this requirement, the Technical Service responsible for approval tests may:
- (a) Require the applicant to supply the equipment necessary to perform the test;
 - (b) Forego the test if the headlamp presented by the applicant is accompanied by a test report, issued by a Technical Service responsible for approval tests for headlamps of the same construction (assembly), confirming compliance with this requirement.
- 4.11.2. Headlamps of classes A, B and D:
- 4.11.2.1. In the case of failure, the luminous intensity above the line H-H shall not exceed the values of a passing-beam according to paragraph 5.2.; in addition, on headlamps designed to provide a passing and/or a driving-beam to become a bend lighting, a minimum luminous intensity of at least 2,500 cd. shall be fulfilled in test point 25 V (VV line, 1.72D).
- 4.11.2.2. Either the principal passing-beam or the driving-beam shall always be obtained without any possibility of the mechanism stopping in between two positions;
- 4.11.3. Headlamps of classes AS, BS, CS, DS and ES:
- 4.11.3.1. Except for additional light source(s) and additional lighting unit(s) used to produce bend lighting, in the case of failure it must be possible to obtain automatically a passing beam or a state with respect to the photometric conditions which yields values not exceeding 1,200 cd in Zone 1 and at least 2400 cd at 0,86D-V by such means as e.g. switching off, dimming, aiming downwards, and/or functional substitution;
- 4.11.3.2. Except for additional light source(s) and additional lighting unit(s) used to produce bend lighting, either the passing beam or the driving beam shall always be obtained without any possibility of the mechanism stopping in between the two positions;
- 4.11.4. AFS:
- 4.11.4.1. Except in the case of adaptation of the driving-beam, either the passing-beam or the driving-beam shall always be obtained, without any possibility of remaining in an intermediate or undefined state; if this is not possible, such a state must be covered by the provisions according to paragraph 4.11.4.2.;
- 4.11.4.2. In the case of failure it must be possible to obtain automatically a passing-beam or a state with respect to the photometric conditions which yields values not exceeding 1,300 cd in the zone III b as defined in paragraph 5.3 and at least 3,400 cd in a point of "segment I_{\max} ", by such means as e.g. switching off, dimming, aiming downwards, and/or functional substitution;
- When performing the tests to verify compliance with these requirements, the Technical Service responsible for approval tests shall refer to the instructions supplied by the applicant.
- 4.11.5. The user cannot, with ordinary tools, change the shape or position of the moving parts, or influence the switching device.
- 4.12. Illumination configuration of lamps with asymmetrical "cut-off" line only for different traffic conditions

- 4.12.1. In the case of lamps designed to meet the requirements of traffic moving on one side of the road (either right or left) only, appropriate measures shall be taken to prevent discomfort to road-users in a country where traffic moves on the side of the road opposite to that of the country for which the headlamp was designed⁸. Such measures may be:
- (a) Occulting a part of the outer lens area;
 - (b) Downward movement of the beam. Horizontal movement is allowed;
 - (c) Any other measure to remove or reduce the asymmetrical part of the beam.
- 4.12.2. Following the application of the measures described in paragraph 4.12.1. the following requirements regarding the luminous intensity of the lamp shall be met with the adjustment left unchanged compared to that for the original traffic direction:
- 4.12.2.1. Passing-beam designed for right-hand traffic and adapted to left-hand traffic:
at 0.86D-1.72L at least 2,500 cd;
at 0.57U-3.43R not more than 880 cd.
- 4.12.2.2. Passing-beam designed for left-hand traffic and adapted to right-hand traffic:
at 0.86D-1.72R at least 2,500 cd;
at 0.57U-3.43L not more than 880 cd.
- 4.13. If applicable, the lamp shall be so made that a failure signal in order to comply with the relevant provisions of UN Regulation No. 48 is provided.
- 4.14. The component(s) to which a replaceable light source is assembled shall be so made that the light source fits easily and, even in darkness, can be fitted in no position but the correct one.
- 4.15. For photometric adjustment and measuring conditions, see Annex 4.
- 4.15.1. In the case of lamps with replaceable light sources, the lamp shall be considered acceptable if it meets the requirements of paragraph 5. with at least one standard (étalon) light source, which may be submitted with the lamp.
- 4.16. Colour of light emitted:

The colour of the light emitted shall be white for all lamps. However, for front fog lamps the colour of the light emitted may be selective yellow if requested by the applicant.

For cornering lamps the colour of the light emitted inside the field of the light distribution grid defined in Annex 4, Figure A4-XII shall be white. Outside this field, no sharp variation of colours shall be observed.
- 4.16.1. The colorimetric characteristics of the lamps incorporating LED modules shall be measured according to paragraph 4.3.2. of Annex 9.
- 4.17. In the case of headlamps or AFS with adjustable reflector the requirements of paragraphs 5.1. to 5.4. are applicable for each mounting position indicated

⁸ Instructions on the installation of lamps fitted with the measures are given in UN Regulation No. 48.

according to paragraph 3.1.3. For verification the following procedure shall be used:

- 4.17.1. Each applied position is realized on the test goniometer with respect to a line joining the centre of the light source and point HV on a aiming screen. The adjustable reflector/system or part(s) thereof is then moved into such a position that the light pattern on the screen corresponds to the relevant aiming prescriptions;
- 4.17.2. With the reflector/system or part(s) thereof initially fixed according to paragraph 4.17.1., the device or part(s) thereof must meet the relevant photometric requirements of paragraphs 5.1. to 5.4.;
- 4.17.3. Additional tests-shall be made after the reflector/system or part(s) thereof has been moved vertically $\pm 2^\circ$ or at least into the maximum position, if less than 2° , from its initial position by means of the headlamps/systems or part(s) thereof adjusting device. Having re-aimed the headlamp/system or part(s) thereof as a whole (by means of the goniometer for example) in the corresponding opposite direction the light output in the following directions shall be controlled and lie within the required limits:
- passing-beam: for headlamp points B50L and 75 R (B50R and 75 L, respectively);
 for AFS points B50L and 75R, or 50R if applicable;
 for class AS, BS, CS, DS, and ES, points HV and 0.86D-V;
- driving-beam: I_M and point HV (percentage of I_M).
- 4.17.4. If the applicant has indicated more than one mounting position, the procedure of paragraphs 4.17.1. to 4.17.3. shall be repeated for all other positions;
- 4.17.5. If the applicant has not asked for special mounting positions, the headlamp/system or part(s) thereof shall be aimed for measurements of paragraphs 5.1. to 5.4. with the relevant adjusting device(s) in its mean position. The additional test of paragraph 4.17.3. shall be made with the reflector/system or part(s) thereof moved into its extreme positions (instead of $\pm 2^\circ$) by means of the relevant adjusting device(s).

5. Specific Technical Requirements

- 5.1. Technical requirements concerning driving-beam of the Class A, B, D (GDL), BS, CS, DS or ES (GDL) (symbols "R", "HR", "DR", "XR", "R-BS", "WR-CS", "WR-DS" or "WR-ES")
- 5.1.1. In the case of a road illumination device designed to provide a driving-beam and a passing-beam, measurements of the luminous intensity of the driving-beam shall be taken with the same alignment as for measurements under paragraphs 5.2. to 5.4.

In the case of a road illumination device providing a driving-beam only, it shall be so adjusted that the area of maximum luminous intensity is centred on the point of intersection of lines H-H and V-V; such a device needs to meet only the requirements referred to in paragraph 5.1.3.

For devices where more than one light source is used to provide the driving-beam, these light sources shall be operated simultaneously to determine the maximum value of the luminous intensity (I_M).

It is also possible that a part of the driving beam produced by one of these light sources will be used exclusively for short time signals "flash to pass" as declared by the applicant. This shall be indicated in the relevant drawing and a remark shall be made in the communication form.

- 5.1.2. Irrespective of the type of light source used to produce the principal passing-beam, several light sources are allowed to be used for each individual driving-beam.
- 5.1.3. Requirements for the luminous intensity distribution of the driving-beams:
- 5.1.3.1. Referring to Figure A4-II the luminous intensity distribution of the driving-beam shall meet the following requirements.

Table 5
Luminous intensity requirements for driving-beam

		<i>Class A Headlamp</i>	<i>Class B Headlamp</i>	<i>Class D Headlamp</i>
<i>Test point</i>	<i>Angular coordinates Degrees</i>	<i>Required luminous intensity cd</i>	<i>Required luminous intensity cd</i>	<i>Required luminous intensity cd</i>
		<i>Min</i>	<i>Min</i>	<i>Min</i>
I_M		27,000	40,500	43,800
H-5L	0.0, 5.0 L	3,400	5,100	6,250
H-2.5L	0.0, 2.5 L	13,500	20,300	25,000
H-2.5R	0.0, 2.5 R	13,500	20,300	25,000
H-5R	0.0, 5.0 R	3,400	5,100	6,250

- 5.1.3.2. Referring to Figure A4-III the luminous intensity distribution of a primary driving-beam shall meet the following requirements.

Table 6
Luminous intensity distribution of a primary driving-beam

<i>Test point number</i>	<i>Test point angular coordinates - degrees*</i>	<i>Required luminous intensity [cd]</i>					
		<i>Class BS</i>		<i>Class CS</i>		<i>Class DS, ES</i>	
		<i>MIN</i>	<i>MAX</i>	<i>MIN</i>	<i>MAX</i>	<i>MIN</i>	<i>MAX</i>
1	H-V	16,000	---	20,000	---	30,000	---
2	H-2.5°R and 2.5°L	9,000	---	10,000	---	20,000	---
3	H-5°R and 5°L	2,500	---	3,500	---	5,000	---
4	H-9°R and 9°L	---	---	2000	---	3,400	---
5	H-12°R and 12°L	---	---	600	---	1,000	---
6	2°U-V	---	---	1000	---	1,700	---
	MIN luminous intensity of the maximum (I_M)	20,000	---	25,000	---	40,000	---

Test point number	Test point angular coordinates - degrees*	Required luminous intensity [cd]					
		Class BS		Class CS		Class DS, ES	
		MIN	MAX	MIN	MAX	MIN	MAX
	MAX luminous intensity of the maximum (I _M)	---	215,000	---	215,000	---	215,000

* 0.25° tolerance allowed independently at each test point for photometry unless indicated otherwise.

5.1.3.3. Referring to Figure A4-IV the luminous intensity distribution of a secondary driving-beam shall meet the following requirements.

Table 7
Luminous intensity distribution of a secondary driving-beam

Test point number	Test point angular coordinates - degrees*	Required luminous intensity [cd]					
		Class BS		Class CS		Classes DS, ES	
		MIN	MAX	MIN	MAX	MIN	MAX
1	H-V	16,000	---	20,000	---	30,000	---
2	H-2.5°R and 2.5°L	9,000	---	10,000	---	20,000	---
3	H-5°R and 5°L	2,500	---	3,500	---	5,000	---
6	2°U-V	---	---	1,000	---	1,700	---
	MIN luminous intensity of the maximum (I _M)	20,000	---	25,000	---	40,000	---
	MAX luminous intensity of the maximum (I _M)	---	215,000	---	215,000	---	215,000

* 0.25° tolerance allowed independently at each test point for photometry unless indicated otherwise.

5.1.3.4. Except for classes BS, CS, DS and ES, the point of intersection (HV) of lines h h and v v shall be situated within the isocandela 80 per cent of maximum luminous intensity (I_{max})

5.1.3.5. The maximum value (I_M) shall in no circumstances exceed 215,000 cd.

5.1.3.6. The reference mark (I'_M) of the maximum luminous intensity shall be obtained by the ratio:

$$I'_M = I_M / 4,300$$

This value shall be rounded off to the value 5 - 7.5 - 10 - 12.5 - 17.5 - 20 - 25 - 27.5 - 30 - 37.5 - 40 - 45 - 50.

5.2. Technical requirements concerning headlamps to provide a passing-beam of the Class A, B and D (GDL) (symbols “C”, “HC” and “DC”)

5.2.1. The headlamp shall be aimed according to Annex 5, paragraph 1.2.

If, however, vertical adjustment cannot be performed repeatedly to the required position within the allowed tolerances, the instrumental method of Annex 5, paragraph 2. shall be applied to test compliance with the required minimum quality of the "cut-off" line and to perform the beam vertical adjustment.

- 5.2.1.1. When so aimed, the headlamp shall:
- (i) If its approval is sought solely for provision of a passing-beam⁹, comply with the requirements set out in paragraph 5.2.2.;
 - (ii) If it is intended to provide both a passing-beam and a driving-beam, comply with the requirements set out in paragraphs 5.2.2. and 5.1.
- 5.2.1.2. Where a headlamp so aimed does not meet the requirements set out in paragraphs 5.2.2. and 5.1., its alignment may be changed according to the provisions in Annex 5, paragraph 1.2.3.
- 5.2.2. The passing-beam shall meet the luminous intensities at the test points referred to in Table 8 and in Figures A4-V or A4-VI.
- Passing-beam headlamps with gas-discharge light sources shall meet these luminous intensities only after more than 10 minutes after ignition.

Table 8
Luminous intensities of passing-beam (all intensities expressed in cd)

Headlamps for RH traffic***, Passing beam of					Class A		Class B		Class D	
		See beam pattern in Annex 4			Figure A4-V		Figure A4-V		Figure A4-VI	
		Position in degrees								
		horizontal		vertical						
No.	Element	at/from	to	at	min	max	min	max	min	max
1	B50L	3.43 L		0.57 U		350		350		350
2	BR	2.50 R		1.00 U		1,750		1,750		
3	Zone III (see Part C)					625		625		625
4	50R	1.72 R		0.86 D	5,100		10,100		12,500	
5	75R	1.15 R		0.57 D	5,100		10,100		12,500	
6	50V	V		0.86 D			5,100		7,500	
7	50L	3.43 L		0.86 D	3,550	13,200*	6,800	13,200*		18,480
8	75L	3.43 L		0.57 D		10,600		10,600		
9	25L1	3.43L		1.72 D						18,800
10	25L2	9.00 L		1.72 D	1,250		1,700		2,500	
11	25R1	9.00 R		1.72 D	1,250		1,700		2,500	
12	25L3	15.00 L		1.72 D					1,250	
13	25R2	15.00 R		1.72 D					1,250	
14	15L	20.00 L		2.86 D					625	
15	15R	20.00 R		2.86 D					625	
	Segment I A to B	5.15 L	5.15 R	0.86 D					3,750	
	Segment I C to D	2.50 R		1.00 U						1,750
	Segment III and under	9.37 L	8.50 R	4.29 D						12,500
	Zone IV	5.15 L to 5.15 R –			1,700		2,500			

⁹ Such a special "passing beam" headlamp may incorporate a driving beam not subject to requirements.

Headlamps for RH traffic***, Passing beam of						Class A		Class B		Class D		
		See beam pattern in Annex 4				Figure A4-V		Figure A4-V		Figure A4-VI		
		Position in degrees										
		horizontal		vertical								
P	No.	Element	at/from	to	at	min	max	min	max	min	max	
			0.86D to 1.72D									
		Zone I	9.00 L to 9.00 R – 1.72 D to 4.00 D				17,600		< 2I**			
		E _{max} R	Vertical above 1.72D, right of V-V line									43,800
		E _{max} L	Left of V-V line									31,300

Headlamps for RH traffic***			
Part B	Test point	Angular coordinates Degrees	Required luminous intensity in cd
	B1	4.00 U – 8.00 L	Points B1+B2+B3 190 min.
	B2	4.00 U – 0	
	B3	4.00 U – 8.00 R	
	B4	2.00 U – 4.00 L	Points B4+B5+B6 375 min.
	B5	2.00 U – 0	
	B6	2.00 U – 4.00 R	
	B7	0 – 8.00 L	65 min.
	B8	0 – 4.00 L	125 min.

Zone III (bounded by the following coordinates in degree)								
Part C	8.00 L	8.00 L	8.00 R	8.00 R	6.00 R	1.50 R	V-V	4.00 L
	1.00 U	4.00 U	4.00 U	2.00 U	1.50 U	1.50 U	H-H	H-H

Notes: In the Table 8, Part A, B and C:

Letter L means that the point is located on the left of VV line.

Letter R means that the point is located on the right of VV line.

Letter U means the point is located above HH line.

Letter D means the point or segment is located below HH line.

* In case where a headlamp in which LED modules are producing a passing-beam in conjunction with an electronic light source control gear, the measured value shall not be more than 18,500 cd.

** Actual measured value at points 50R / 50L respectively.

*** For left-hand traffic, the letter R shall be replaced by letter L and vice versa.

5.2.3. There shall be no lateral variations detrimental to good visibility in any of the zones I, III and IV.

5.2.4. Headlamps designed to meet the requirements of both right-hand and left-hand traffic shall, in each of the two setting positions of the optical unit, light source(s) or LED module(s) producing the principal passing-beam, meet the requirements set forth above for the corresponding direction of traffic.

- 5.2.5. The requirements in paragraph 5.2.2. shall also apply to headlamps designed to provide bend lighting and/or that include the additional light source(s) or LED module(s) referred to in paragraph 5.2.6.2. In the case of a headlamp designed to provide bend lighting its alignment may be changed, provided that the axis of the beam is not displaced vertically by more than 0.2°.
- 5.2.5.1. If bend lighting is obtained by:
- 5.2.5.1.1. Swivelling the passing-beam or moving horizontally the kink of the elbow of the cut-off, the measurements shall be carried out after the complete headlamp assembly has been reaimed horizontally, e.g. by means of a goniometer;
- 5.2.5.1.2. Moving one or more optical parts of the headlamp without moving horizontally the kink of the elbow of the cut-off, measurements shall be carried out with these parts being in their extreme operating position;
- 5.2.5.1.3. Means of additional light source(s) or LED module(s) without moving horizontally the kink of the elbow of the cut-off, measurements shall be carried out with this/these light source(s) or LED module(s) activated.
- 5.2.6. Only one filament light source, one gas-discharge light source, one or more LED light source(s) or one or more LED module(s) are permitted for the principal passing-beam. Additional light sources or LED modules are permitted only as follows:
- 5.2.6.1. One additional filament light source according to UN Regulation No. 37, one or more additional LED light source(s) according to UN Regulation No. 128 or one or more additional LED module(s) may be used inside the passing-beam headlamp to contribute to bend lighting;
- 5.2.6.2. One additional filament light source according to UN Regulation No. 37, one or more additional LED light source(s) according to UN Regulation No. 128 and/or one or more LED module(s), inside the passing-beam headlamp, may be used for the purposes of generating infrared radiation. It/they shall only be activated at the same time as the principal light source or LED module(s). In the event that the principal light source or (one of) the principal LED module(s) fails, this additional light source and/or LED module(s) shall be automatically switched off;
- 5.2.6.3. In the event of failure of an additional filament light source, one or more additional LED light source(s) or one or more additional LED module(s), the headlamp shall continue to fulfil the requirements of the passing-beam.
- 5.3. Technical requirements concerning adaptive front-lighting systems (AFS) (symbols “XC”, “XCE”, “XCV”, “XCW” and “XR”)
- 5.3.1. General provisions
- 5.3.1.1. Each system shall provide a Class C passing-beam according to paragraph 5.3.2.4. and one or more passing-beam(s) of additional class(es); it may incorporate one or more additional modes within each class of passing-beam and the front-lighting functions according to paragraph 5.3.3. and/or 3.1.3.2.1.
- 5.3.1.2. The system shall provide automatic modifications, such, that good road illumination is achieved and no discomfort is caused, neither to the driver nor to other road users.

- 5.3.1.3. The system shall be considered acceptable if it meets the relevant photometric requirements of paragraphs 5.3.2. and 5.3.3.
- 5.3.1.4. Photometric measurements shall be performed according to the applicant's description:
- 5.3.1.4.1. At neutral state;
- 5.3.1.4.2. At V-signal, W-signal, E-signal, T-signal whichever apply;
- 5.3.1.4.3. If applicable, at any other signal(s) and combinations of them, according to the applicant's specification.
- 5.3.1.4.4. In case of a headlamp using a gas-discharge light source with the ballast not integrated with the light source, four seconds after ignition of a headlamp that has not been operated for 30 minutes or more:
- 5.3.1.4.4.1. At least 37,500 cd shall be attained at point HV, for a system producing driving-beam only.
- 5.3.1.4.4.2. At least 3,100 cd shall be attained at point 50 V when the Class C passing-beam is activated, for systems producing passing-beam only or alternately producing passing-beam and driving-beam functions as described in paragraphs 4.11.1. and 4.11.4.
- 5.3.1.4.4.3. In either case the power supply shall be sufficient to secure the required rise of the high current pulse.
- 5.3.2. Provisions concerning the passing-beam
- The system shall, prior to the subsequent test procedures, be set to the neutral state, emitting the Class C passing-beam.
- 5.3.2.1. For each side of the system (vehicle) the passing-beam in its neutral state shall produce from at least one lighting unit a "cut-off" as defined in Annex 5 or,
- 5.3.2.1.1. The system shall provide other means, e.g. optical features or temporary auxiliary beams, allowing for unambiguous and correct aiming.
- 5.3.2.1.2. Annex 5 does not apply to the traffic-change function as described in paragraph 4.12.
- 5.3.2.2. The system or part(s) thereof shall be aimed according to the requirements of paragraph 1. of Annex 5 so that the position of the cut-off complies with the requirements indicated in the Table 10.
- If, however, vertical adjustment cannot be performed repeatedly to the required position within the allowed tolerances, the instrumental method of Annex 5, paragraph 2. shall be applied to test compliance with the required minimum quality of the "cut-off" line and to perform the beam vertical adjustment.
- 5.3.2.3. When so aimed, the system or part(s) thereof,
- (a) If its approval is sought solely for provision of the passing-beam, needs to comply with the requirements set out in the relevant paragraphs below;
- (b) If it is intended to provide additional lighting or light signalling functions according to the scope of this Regulation, it shall comply in

addition with the requirements set out in the relevant paragraphs below, if not being adjustable independently.

- 5.3.2.4. When emitting a specified mode of the passing-beam, the system shall meet the requirements in the respective section (C, V, E, W) of part A of Table 9 (photometric values) and in Table 10 (I_{\max} and "cut-off" positions), as well as paragraph 1 ("cut-off" requirements) of Annex 5.
- 5.3.2.5. A bending mode may be emitted, provided that:
- 5.3.2.5.1. The system meets the respective requirements of part B of Table 9 (photometric values) and item B of Table 10 ("cut-off" provisions), when measured according to the procedure indicated in paragraph 5.3.4., relevant to the category (either category 1 or category 2) of the bending mode, for which approval is sought;
- 5.3.2.5.2. When the T-signal corresponds to the vehicle's smallest turn radius to the left (or right), the sum of the luminous intensity values provided by all contributors of the right or the left side of the system shall be at least 2,500 cd at one or more points in the zone extending from H-H to 2 degrees below H-H and from 10 to 45 degrees left (or right).
- 5.3.2.5.3. If approval is sought for a category 1 bending mode, the use of the system is restricted to vehicles where provisions are taken such that the horizontal position of the "kink" of the "cut-off" which is provided by the system, complies with the relevant provisions of paragraph 6.22.7.4.5. (i) of UN Regulation No. 48;
- 5.3.2.5.4. If approval is sought for a category 1 bending mode, the system is designed so that, in the case of a failure affecting the lateral movement or modification of the illumination, it must be possible to obtain automatically either photometric conditions corresponding to paragraph 5.3.2.4. or a state with respect to the photometric conditions which yields values not exceeding 1,300 cd in the zone IIIb, as defined in Table 11, and at least 3,400 cd in a point of "segment I_{\max} ";
- However, this is not needed if, for positions relative to the system reference axis up to 5 degrees left, at 0.3 degree up from H-H, and greater than 5 degrees left, at 0.57 degree up, a value of 880 cd is in no case exceeded.
- 5.3.2.6. The system shall be checked on the basis of the relevant instructions of the manufacturer, indicated in the safety concept according to paragraph 3.1.3.3.1.
- 5.3.2.7. A system or part(s) thereof, designed to meet the requirements of both right-hand and left-hand traffic must, in each of the two setting positions according to paragraph 4.10. meet the requirements specified for the corresponding direction of traffic.
- 5.3.2.8. The system shall be so made that:
- 5.3.2.8.1. Any specified passing-beam mode provides at least 2,500 cd at point 50V from each side of the system;
- The mode(s) of the Class V passing-beam are exempted from this requirement;
- 5.3.2.8.2. Other modes:
- When signal inputs according to paragraph 5.3.1.5.3. apply, the requirements of the paragraph 5.3.2. shall be fulfilled.

Table 9
Passing-beam photometric requirements in conjunction with Figure A4-VII

Tabled requirements expressed in cd			Position / deg.			Passing beam							
			horizontal		vertical	Class C		Class V		Class E		Class W	
No.	Element	At/from	to	at	min	max	min	max	min	max	min	max	
Part A	1	B50L	L 3.43	-	U 0.57	As specified in Table 17 column A	50	350	50	625 ⁷	50	625	
	3	BR	R 2.50	-	U 1.00		50	880	50	1 750	50	2 650	
	4	Segment BRR	R 8.00	R 20	U 0.57		-	880	-	3 550	-	5 300	
	5	Segment BLL	L 8.00	L 20	U 0.57		-	880	-	880	-	880	
	6	P	L 7.00	-	H		-	-	-	-	63	-	
	7	Zone III	As specified in Table 11				-	625	-	880	-	880	
	8a	S50+S50LL+S50RR ⁵	-	-	U 4.00		-	-	190 ⁶	-	190 ⁶	-	
	9a	S100+S100LL+S100RR ⁵	-	-	U 2.00		-	-	375 ⁶	-	375 ⁶	-	
	10	50 R	R 1.72	-	D 0.86		5 100	-	-	-	-	-	
	11	75 R	R 1.15	-	D 0.57		-	-	15 200	-	20 300	-	
	12	50 V	V	-	D 0.86		5 100	-	10 100	-	10 100	-	
	13	50 L	L 3.43	-	D 0.86		3 550	13 200 ⁸	6 800	-	6 800	26 400 ⁸	
	14	25 LL	L 16.00	-	D 1.72		845	-	1 180	-	3 400	-	
	15	25 RR	R 11.00	-	D 1.72		845	-	1 180	-	3 400	-	
	16	Segment 20 and below	L 3.50	V	D 2.00		-	-	-	-	-	17 600 ²	
	17	Segment 10 and below	L 4.50	R 2.00	D 4.00		-	12 300 ¹	-	12 300 ¹	-	7 100 ²	
	18	I _{max} ³	-	-	-		8 400	44 100	16 900	79 300 ⁷	29 530	70 500 ²	

Part B (bending mode): Table 9 applies, however with the lines Nos. 1,7,13 and 18 being replaced by those listed hereunder

Part B	1	B50L	L 3.43	-	U 0.57	50 ⁴	530	50	350	50	625	50	625
	7	Zone III	As specified in Table 11			-	880	-	880	-	880	-	880
	13	50 L	L 3.43	-	D 0.86	1 700	-	1 700	-	3 400	-	3 400	
	18	I _{max}	-	-	-	10 100	44 100	5 100	44 100	10 100	79 300 ⁷	20 300	70 500 ²

Notes: In the Table 9, Part A and B:

- ¹ Max 15 900 cd, if the system is designed to provide also a Class W passing-beam.
- ² Requirements according to the provisions indicated in Table 12 apply in addition.
- ³ Position requirements according to the provisions of Table 10 ("Segment I_{max}").
- ⁴ The contribution of each side of the system (for segment BLL and BRR: of at least one point), when measured according to the provisions of Annex 4 shall not be less than 50 cd.
- ⁵ Position requirements according to the provisions of Table 13.
- ⁶ One pair of position lamps, being incorporated with the system or being intended to be installed together with the system may be activated according to the indications of the applicant.
- ⁷ Requirements according to the provisions indicated in Table 14 apply in addition.
- ⁸ The max. value may be multiplied by 1.4, if it is guaranteed according to the manufacturer's description that this value will not be exceeded in use, either by means of the system or, if the system's use is confined to vehicles, providing a corresponding stabilization/limitation of the system's supply, as indicated in the communication form.

Table 10
Passing-beam elements angular position/extend, additional requirements

	Beam part designation and requirement	Class C passing-beam		Class V passing-beam		Class E passing-beam		Class W passing-beam	
		Horiz.	Vert.	Horiz.	Vert.	Horiz.	Vert.	Horiz.	Vert.
A	Angular position / extend in degrees for segment I _{max} The maximum luminous intensity in "Segment I _{max} " as indicated in this Table shall be within the limits as prescribed in Table 9, No. 18.	0.5 L to 3 R	0.3 D to 1.72D		0.3 D to 1.72D	0.5 L to 3 R	0.1 D to 1.72D	0.5 L to 3 R	0.3 D to 1.72D
B	The "cut-off" and part(s) of shall: (a) comply with the requirements of paragraph 1. of Annex 5 and								
	(b) be positioned with its "flat horizontal part"		at V = 0.57 D		not above 0.57D not below 1.3D		not above 0.23D ¹ not below 0.57D		not above 0.23D not below 0.57D

Note to Table 10:

¹ Requirements according to the provisions indicated in Table 9 apply in addition.

Table 11:
Passing-beam zones III, defining corner points

Angular position in degrees	Corner point No.	1	2	3	4	5	6	7	8
Zone III a for Class C or Class V Passing Beam	horizontal	8 L	8 L	8 R	8 R	6 R	1.5 R	V-V	4 L
	vertical	1 U	4 U	4 U	2 U	1.5 U	1.5 U	H-H	H-H
Zone III b for Class W or Class E Passing Beam	horizontal	8 L	8 L	8 R	8 R	6 R	1.5 R	0.5 L	4 L
	vertical	1 U	4 U	4 U	2 U	1.5 U	1.5 U	0.34 U	0.34 U

Table 12:
Additional provisions for Class W passing-beam, expressed in cd

Definition and requirements for segments E, F1, F2, and F3 (not shown in Table 9 and Figure A4-VII of Annex 4).
Not more than 175 cd is allowed: a) on a segment E extending at U 10 deg from L 20 to R 20 deg and b) on three vertical segments F1, F2 and F3 at horizontal positions L10 degrees, V and R 10 degrees, each extending from U 10 to U 60 degrees.
Alternative/ Additional set of requirements for I _{max} , segment 20 and segment 10: Table 9 Part A or B applies, however with the max requirements in lines No. 16, 17 and 18 being replaced by those indicated hereunder.
If, according to the applicants specification according to paragraph 3.1.3.2.(e) a Class W passing-beam is designed to produce on segment 20 and below it not more than 8,800 cd and on segment 10 and below it not more than 3,550 cd, the design value for I _{max} of that beam shall not exceed 88,100 cd.

Table 13

Overhead sign requirements, angular position of measurement points

Point designation	S50LL	S50	S50RR	S100LL	S100	S100RR
Angular position in degrees	4 U / 8 L	4 U / V-V	4 U / 8 R	2 U / 4 L	2 U / V-V	0 U / 4 R

Table 14

Additional provisions for Class E passing-beam

Table 9, Part A or B and Table 10 apply, however with the lines No.1 and 18 of Table 9 and item B of Table 10 being replaced as indicated hereunder			
<i>Designation</i>	<i>Line 1 of Table 9, Part A or B</i>	<i>No.18 of Table 9, Part A or B</i>	<i>Item B of Table 10</i>
<i>Data Set</i>	<i>EB50L in cd</i>	<i>I_{max} in cd</i>	<i>cut-off flat part aimed in degrees</i>
	max	max	not above
E1	530	70500	0.34 D
E2	440	61700	0.45 D
E3	350	52900	0.57 D

Table 15

Requirements concerning the adaptation of the driving-beam according to paragraph 5.3.3.7.

<i>Part A</i>	<i>Test point</i>	<i>Position / Deg.</i>		<i>Max. intensity** (cd)</i>
		<i>Horizontal</i>	<i>Vertical</i>	
	Line 1 Left Oncoming vehicle at 50 m in the case of right-hand traffic	4.8°L to 2°L	0.57°Up	625
	Line 1 Right Oncoming vehicle at 50 m in the case of left-hand traffic	2°R to 4.8°R	0.57°Up	625
	Line 2 Left Oncoming vehicle at 100 m in the case of right-hand traffic	2.4°L to 1°L	0.3°Up	1 750
	Line 2 Right Oncoming vehicle at 100 m in the case of left-hand traffic	1°R to 2.4°R	0.3°Up	1 750
	Line 3 Left Oncoming vehicle at 200 m in the case of right-hand traffic	1.2°L to 0.5°L	0.15°Up	5 450
	Line 3 Right Oncoming vehicle at 200 m in the case of left-hand traffic	0.5°R to 1.2°R	0.15°Up	5 450
	Line 4 Preceding vehicle at 50 m in the case of right-hand traffic	1.7°L to 1.0°R >1.0° R to 1.7°R	0.3°Up	1 850
	Line 4	1.7°R to 1.0°L		2 500

	Preceding vehicle at 50 m in the case of left-hand traffic	>1.0° L to 1.7°L		2 500
	Line 5 Preceding vehicle at 100 m in the case of right-hand traffic	0.9° L to 0.5°R	0.15°Up	5 300
		>0.5°R to 0.9°R		7 000
	Line 5 Preceding vehicle at 100 m in the case of left-hand traffic	0.9° R to 0.5°L		5 300
		>0.5°L to 0.9°L		7 000
Line 6 Preceding vehicle at 200 m in the case of left-hand traffic and right-hand traffic	0.45°L to 0.45°R	0.1°Up	16 000	

<i>Part B</i>	<i>Test Point</i>	<i>Position /degrees*</i>		<i>Min. Intensity**</i>
		<i>Horizontal</i>	<i>Vertical</i>	<i>(cd)</i>
	50R	1.72 R	D 0.86	5 100
	50V	V	D 0.86	5 100
	50L	3.43 L	D 0.86	2 550
	25LL	16 L	D 1.72	1 180
	25RR	11 R	D 1.72	1 180

* Angular positions are indicated for right-hand traffic.

** The photometric requirements for each single measuring point (angular position) of this lighting function apply to half of the sum of the respective measured values from all lighting units of the system applied for this function.

Each of the lines defined in part A of Table 15, in conjunction with the test points as prescribed in part B of Table 15 shall be measured individually corresponding to the signal provided by the signal generator.

In the case where the passing-beam, which meets the requirements of paragraph 5.3.2., is continuously operated in conjunction with the adaptation of the driving-beam, the photometric requirements in Part B of the Table 15 shall not be applied.

5.3.3. Provisions concerning the driving-beam

The system shall, prior to the subsequent test procedures, be set to the neutral state.

5.3.3.1. The lighting unit(s) of the system shall be adjusted, according to the instructions of the manufacturer, such that the area of maximum illumination is centred on the point (HV) of intersection of the lines H-H and V-V;

5.3.3.1.1. Any lighting unit(s) which is/are not independently adjustable, or, for which the aiming was done with respect to any measurements under paragraphs 5.3.2., shall be tested in its/their unchanged position.

5.3.3.2. When measured according to the provisions laid down in paragraph 5.1. the luminous intensity shall meet the requirements of Class B in Table 5 and of paragraph 5.1.3.4.

- 5.3.3.3. The illumination or part thereof emitted by an AFS may be automatically laterally moved (or modified to obtain an equivalent effect), provided that:
 - 5.3.3.3.1. The system meets the requirements of the paragraphs 5.1.3.1. class B and 5.1.3.4. above with each lighting unit measured according to the relevant procedure indicated in paragraph 5.3.4.
 - 5.3.3.4. The system shall be so made that:
 - 5.3.3.4.1. The lighting unit(s) of the right side and of the left side each provide at least 16,200 cd at the point HV:
 - 5.3.3.5. If the specified beam requirements are not met, a re-aiming of the beam position within 0.5 degree up or down and/or 1 degree to the right or left, with respect to its initial aiming is allowed; in the revised position all photometric requirements shall be met. These provisions do not apply to lighting units as indicated under paragraph 5.3.3.1.1.
 - 5.3.3.6. In the case of adaptation of the driving-beam function the system shall meet the requirements of the above paragraphs only when it is in the maximum condition of activation.
 - 5.3.3.7. During adaptation, the driving-beam function shall meet the requirements for all the cases of right-hand and left-hand traffic specified in Part A of Table 15. These requirements shall be verified during the type approval testing in conjunction with a signal generator to be provided by the applicant. This signal generator shall reproduce the signals provided by the vehicle and cause the adaptation of the driving-beam and in particular shall represent the settings so that the photometric compliance can be verified.
 - 5.3.3.7.1. If the driving-beam function meets the requirements in Part A of Table 15 specified for line 1 to line 3 for oncoming and preceding vehicles (symmetrical beam) the relevant information shall be noticed in the communication document in Annex 1.
 - 5.3.3.7.2. If the requirements of paragraph 5.3.3.7. can be met for right-hand traffic or left-hand traffic only, the relevant information shall be reported in the communication document in Annex 1.
 - 5.3.4. Measurement conditions with respect to bending modes
 - 5.3.4.1. In the case of a system or part(s) thereof, which provide a bending mode, the requirements of paragraphs 5.3.2. (passing-beam), and /or 5.3.3. (driving-beam) apply for all states, corresponding to the turn radius of the vehicle. For verification with respect to the passing-beam and the driving-beam the following procedure shall be used:
 - 5.3.4.1.1. The system shall be tested in the neutral state (central/straight), and, in addition in the state(s) corresponding to the smallest turn radius of the vehicle in both directions using the signal generator, if applicable.
 - 5.3.4.1.1.1. Compliance with the requirements of paragraphs 5.3.2.5.2. and 5.3.2.5.4. shall be checked for both category 1 and category 2 bending modes without additional horizontal re-aim.
 - 5.3.4.1.1.2. Compliance with the requirements of paragraphs 5.3.2.5.1. and 5.3.3., whichever applies, shall be checked:
 - (a) In case of a category 2 bending mode: without additional horizontal re-aim;

- (b) In case of a category 1 or a driving-beam bending mode: after having horizontally re-aimed the relevant installation unit (by means of the goniometer for example) in the corresponding opposite direction.
- 5.3.4.1.2. When testing a category 1 or category 2 bending mode, for a turn radius of the vehicle other than specified in paragraph 5.3.4.1.1. it shall be observed whether the light distribution is substantially uniform and no undue glare occurs. If this cannot be confirmed the compliance with the requirement laid down in Table 9 shall be checked.
- 5.3.5. Other provisions
- 5.3.5.1. It shall be stated by means of a form conforming to the model in Annex 1, which lighting unit(s) provide a "cut-off" as defined in Annex 5, that projects into a zone extending from 6 degrees left to 4 degrees right and upwards from a horizontal line positioned at 0.8 degrees down.
- 5.3.5.2. It shall be stated by means of a form conforming to the model in Annex 1, which Class E passing-beam mode(s), if any, comply with a "data set" of Table 14.
- 5.3.6. Photometric requirements for conformity of production
- 5.3.6.1. General
- The general requirements for the Production Conformity tests are defined in Annex 2 and Annex 3. Additionally the specific tests described in relation to the photometric requirements concerning adaptive front-lighting systems (AFS) shall apply as described below.
- These requirements apply only for the entire system and apply to half of the sum of the respective measured values from all lighting units of the system applied for this function or mode, or, from all lighting units as indicated in the respective requirement.
- As an alternative to the re-alignment procedure as described in paragraph 1.2.3. of Annex 2, the intensity requirement of column A, B or C of Tables 17 to 32 for a particular direction of observation shall be deemed to be satisfied if that requirement is met in a direction deviating by not more than one-quarter of a degree from the direction of observation.
- 5.3.6.2. Passing Beam Photometric Requirements

Table 16
Decision Table

	<i>"Multiple Modes"- Condition</i> * if more than one mode of the applicable Class exist only the mode which represents the worst condition has to be tested in non-bending mode according to	<i>"Bending Modes" - Condition</i> if the system uses the same functional units to obtain bending modes for more than one class:	
		Yes	No
Class C	Table 17 *		
Category 1 bending mode	→	** the bending modes shall only be tested in the Class which represents the worst condition	Table 18
Category 2 bending mode		Test category 2 bending mode according to Table 19	
Class V Non Bending Mode	Table 20 *		
Class V Category 1 bending mode	→	see **	Table 21
Class V Category 2 bending mode			Table 22
Class W Non-bending mode	Table 23 *		
Class W Category 1 bending mode	→	see **	Table 24
Class W Category 2 bending mode			Table 25
Class E	if more than one mode of Class E exists only the mode Class E which relates to the highest cut-off position has to be tested in non-bending mode according to corresponding Table 26 to Table 29	No additional testing of Category 1 and/or Category 2 is necessary	

5.3.6.3. Driving Beam Photometric Requirements

5.3.6.3.1. Driving Beam – Neutral State

If there is more than one mode of the driving beam only the mode corresponding to the neutral state shall be tested for CoP according to Table 30

5.3.6.3.1.1. Driving Beam –bending mode –if applicable:

If the system uses the same functional units to obtain bending modes for more than one class, no further testing of the bending modes of Category 1 and/or Category 2) is necessary

If not, the system shall be tested according to Table 31.

5.3.6.3.2. Adaptive Driving Beam–if applicable:

During adaptation, the driving-beam function shall meet the requirements for all the cases of Right-Hand and/or Left-Hand traffic specified in Part A of Table 32

If the system uses the same functional units for the adaptation of the driving beam only Line 1 and Line 4 of Table 32 have to be measured.

In the case where the passing beam, which meets the requirements of 5.3.6.2 is continuously operated in conjunction with the adaptation of the driving beam, the photometric requirements in Part B Table 32 shall not be applied.

Table 17

Class C – Neutral State – System Requirements

<i>Class C – non-bending mode</i>		<i>Position/deg</i>				<i>Column A</i>		<i>Column B</i>		<i>Column C</i>			
<i>Tabled requirements expressed in cd.</i>		<i>horizontal</i>			<i>vertical</i>		$\triangleq 0\% \text{ CoP}$		$\triangleq 20\% \text{ CoP}$		$\triangleq 30\% \text{ CoP}$		
<i>No</i>	<i>Element</i>	<i>at/</i>	<i>from</i>	<i>to</i>	<i>at</i>	<i>min</i>	<i>max</i>	<i>min</i>	<i>max</i>	<i>min</i>	<i>max</i>		
1	B50L	L	3.43		U	0.57	50	350	25	520	10	605	
3	BR	R	2.5		U	1	50	1750	25	2100	10	2275	
4	Point BRR	R	8		U	0.57	50	3550	25	4260	10	4615	
5	Point BLL	L	8		U	0.57	50	625	25	880	10	1005	
7	Line III	L	4	V	V	H		625		880		1005	
8a	S50+S50LL+S50RR ³				U	4	190 ²	1875	95 ²	2250	45 ²	2440	
9a	S100+S100LL+S100RR ³				U	2	375 ²	1875	185 ²	2250	90 ²	2440	
10	50 R	R	1.72		D	0.86		44100		52920		57330	
11	75 R	R	1.15		D	0.57	10100	44100	8080	52920	7070	57330	
12	50 V	V			D	0.86	5100	44100	4080	52920	3570	57330	
13	50 L	L	3.43		D	0.86	3550	13200 ⁴	2840	15840 ⁴	2485	17160 ⁴	
14	25 LL	L	16		D	1.72	1180	44100	944	52920	826	57330	
15	25 RR	R	11		D	1.72	1180	44100	944	52920	826	57330	
17	Line 10	L	4.5	R	2.0	D	4		12300 ¹		14760 ¹		15990 ¹

Notes to Table 17:

¹ Shall be multiplied by 1.3, if the system is designed to provide also a class W passing beam.

² One pair of position lamps, being incorporated with the system or being intended to be installed together with the system may be activated according to the indications of the applicant.

³ Position requirements according to the provisions of Figure A4-VII.

⁴ The maximum value may be multiplied by 1.4, if it is guaranteed according to the manufacturer's description that this value will not be exceeded in use, either by means of the system or, if the system's use is confined to vehicles, providing a corresponding stabilization/limitation of the system's supply, as indicated in the communication form.

Table 18
Class C – Bendlight – Category 1 – System Requirements

Class C – Bendlight Cat. 1		Position/deg					Column A		Column B		Column C		
Tabled requirements expressed in cd		horizontal			vertical		± 0% CoP		± 20% CoP		± 30% CoP		
No	Element	at/	from	to		at		min	max	min	max	min	max
1	B50L	L	3.43			U	0.57		530		700		785
3	BR	R	2.5			U	1		1750		2100		2275
4	Point BRR	R	8			U	0.57		3550		4260		4615
5	Point BLL	L	8			U	0.57		625		880		1005
7	Line III	L	4	V	V	H			880		1135		1260
10	50 R	R	1.72			D	0.86		44100		52920		57330
11	75 R	R	1.15			D	0.57	10100	44100	8080	52920	7070	57330
12	50 V	V				D	0.86	5100	44100	4080	52920	3570	57330
13	50 L	L	3.43			D	0.86	1700	13200 ¹	2840	15840 ¹	2485	17160 ¹

Note to Table 18:

¹ The maximum value may be multiplied by 1.4, if it is guaranteed according to the manufacturer's description that this value will not be exceeded in use, either by means of the system or, if the system's use is confined to vehicles, providing a corresponding stabilization/limitation of the system's supply, as indicated in the communication form.

Table 19
Class C – Bendlight – Category 2 – System Requirements

Class C – Bendlight Cat. 2		Position/deg					Column A		Column B		Column C		
Tabled requirements expressed in cd		horizontal			vertical		± 0% CoP		± 20% CoP		± 30% CoP		
No	Element	at/	from	to		at		min	max	min	max	min	max
1	B50L	L	3.43			U	0.57		530		700		785
3	BR	R	2.5			U	1		1750		2100		2275
4	Line BRR	R	8	R	20	U	0.57		3550		4260		4615
5	Line BLL	L	8	L	20	U	0.57		625		880		1005
7	Line III	L	4	V	V	H			880		1135		1260

Table 20:
Class V – non-bending mode – System Requirements

<i>Class V -non-bending mode</i>		<i>Position/deg</i>						<i>Column A</i>		<i>Column B</i>		<i>Column C</i>	
<i>Tabled requirements expressed in cd</i>		<i>horizontal</i>				<i>vertical</i>		$\pm 0\%$ <i>CoP</i>		$\pm 20\%$ <i>CoP</i>		$\pm 30\%$ <i>CoP</i>	
<i>No</i>	<i>Element</i>	<i>at/</i>	<i>from</i>	<i>to</i>		<i>at</i>		<i>min</i>	<i>max</i>	<i>min</i>	<i>max</i>	<i>min</i>	<i>max</i>
1	B50L	L	3.43			U	0.57		350		520		605
3	BR	R	2.5			U	1		880		1135		1260
4	Point BRR	R	8			U	0.57		880		1135		1260
5	Point BLL	L	8			U	0.57		880		1135		1260
7	Line III	L	4	V	V	H			625		880		1005
10	50 R	R	1.72			D	0.86	5100	44100	4080	52920	3570	57330
13	50 L	L	3.43			D	0.86	3550	13200 ¹	2840	15840 ¹	2485	17160 ¹

Note to Table 20:

¹ The maximum value may be multiplied by 1.4, if it is guaranteed according to the manufacturer's description that value will not be exceeded in use, either by means of the system or, if the system's use is confined to vehicles, providing a corresponding stabilization/limitation of the system's supply, as indicated in the communication form.

Table 21
Class V – Bendlight – Category 1 – System Requirements

<i>Class V – Bendlight Cat. 1</i>		<i>Position/deg</i>						<i>Column A</i>		<i>Column B</i>		<i>Column C</i>	
<i>Tabled requirements expressed in cd</i>		<i>horizontal</i>				<i>vertical</i>		$\pm 0\%$ <i>CoP</i>		$\pm 20\%$ <i>CoP</i>		$\pm 30\%$ <i>CoP</i>	
<i>No</i>	<i>Element</i>	<i>at/</i>	<i>from</i>	<i>to</i>		<i>at</i>		<i>min</i>	<i>max</i>	<i>min</i>	<i>max</i>	<i>min</i>	<i>max</i>
1	B50L	L	3.43			U	0.57		530		700		785
3	BR	R	2.5			U	1		880		1135		1260
4	Point BRR	R	8			U	0.57		880		1135		1260
5	Point BLL	L	8			U	0.57		880		1135		1260
7	Line III	L	4	V	V	H			880		1135		1260
10	50 R	R	1.72			D	0.86	5100	44100	4080	52920	3570	57330
13	50 L	L	3.43			D	0.86	1700	13200 ¹	2840	15840 ¹	2485	17160 ¹

Note to Table 21:

¹ The maximum value may be multiplied by 1.4, if it is guaranteed according to the manufacturer's description that this value will not be exceeded in use, either by means of the system or, of the system's use is confined to vehicles, providing a corresponding stabilization/limitation of the system's supply, as indicated in the communication form.

Table 22
Class V – Bendlight – Category 2 – System Requirements

Class V – Bendlight Cat. 2		Position/deg					Column A		Column B		Column C		
Tabled requirements expressed in cd		horizontal			vertical		≅ 0% CoP		≅ 20% CoP		≅ 30% CoP		
No	Element	at/	from	to		at		min	max	min	max	min	max
1	B50L	L	3.43			U	0.57		530		700		785
3	BR	R	2.5			U	1		880		1135		1260
4	Line BRR	R	8	R	20	U	0.57		880		1135		1260
5	Line BLL	L	8	L	20	U	0.57		880		1135		1260
7	Line III	L	4	V	V	H			880		1135		1260

Table 23
Class W – Non-bending mode – System Requirements

Class W – non-bending mode		Position/deg					Column A		Column B		Column C		
Tabled requirements expressed in cd		horizontal			vertical		≅ 0% CoP		≅ 20% CoP		≅ 30% CoP		
No	Element	at/	from	to		at		min	max	min	max	min	max
1	B50L	L	3.43			U	0.57		625		880		1005
3	BR	R	2.5			U	1		2650		3180		3445
4	Point BRR	R	8			U	0.57		5300		6360		6890
5	Point BLL	L	8			U	0.57		880		1135		1260
7	Line III b	L	4	L	0.5	U	0.34		880		1135		1260
11	75 R	R	1.15			D	0.57	20300	70500 ¹	16240	84600 ¹	14210	91650 ¹
13	50 L	L	3.43			D	0.86	6800	26400 ²	5440	31680 ²	4760	34320 ²
14	25 LL	L	16			D	1.72	3400	70500 ¹	2720	84600 ¹	2380	91650 ¹
15	25 RR	R	11			D	1.72	3400	70500 ¹	2720	84600 ¹	2380	91650 ¹
16	Segment 20	L	3.5	V		D	2		17600 ¹		21120 ¹		22880 ¹
17	Segment 10	L	4.5	R	2.0	D	4		12300 ¹		14760 ¹		15990 ¹
	Line E	L	20	R	20	U	10		175		260		300

Notes to Table 23:

¹ If, according to the applicants specification according to paragraph 3.1.3.2. (e) of this Regulation a class W passing beam is designed to produce on segment 20 and below it not more than 8,800 cd (10,560 cd corresponds to 20% CoP, 11,440 cd corresponds to 30% CoP) and on segment 10 and below it not more than 3,550 cd (4,260 cd corresponds to 20% CoP and 4,615 cd corresponds to 30% CoP), the design value for I_{max} of that beam shall not exceed 88,100 cd (105,720 corresponds to 20% CoP, 114,530 cd corresponds to 30% CoP).

² The maximum value may be multiplied by 1.4, if it is guaranteed according to the manufacturer's description that this value will not be exceeded in use, either by means of the system or, if the system's use is confined to vehicles, providing a corresponding stabilization/limitation of the system's supply, as indicated in the communication form.

Table 24
Class W – Bendlight – Category 1 – System Requirements

Class W – Bendlight Cat. 1		Position/deg					Column A		Column B		Column C		
Tabled requirements expressed in cd		horizontal			vertical		≅ 0% CoP		≅ 20% CoP		≅ 30% CoP		
No	Element	at/	from	to		at		min	max	min	max	min	max
1	B50L	L	3.43			U	0.57		790		960		1045
3	BR	R	2.5			U	1		2650		3180		3445
4	Point BRR	R	8			U	0.57		5300		6360		6890
5	Point BLL	L	8			U	0.57		880		1135		1260
7	Line III b	L	4	L	0.5	U	0.34		880		1135		1260
11	75 R	R	1.15			D	0.57	20300	70500 ¹	16240	84600 ¹	14210	91650 ¹
13	50 L	L	3.43			D	0.86	3400	13200 ²	2720	15840 ²	2380	17160 ²

Notes to Table 24:

¹ If, according to the applicants specification according to paragraph 3.1.3.2 (e) of this Regulation a class W passing beam is designed to produce on segment 20 and below it not more than 8,800 cd (10,560 cd corresponds to 20% CoP, 11,440 cd corresponds to 30% CoP) and on segment 10 and below it not more than 3,550 cd (4,260 cd corresponds to 20% CoP and 4,615 cd corresponds to 30% CoP), the design value for I_{max} of that beam shall not exceed 88,100 cd (105,720 corresponds to 20% CoP, 114,530 cd corresponds to 30% CoP).

² The maximum value may be multiplied by 1.4, if it is guaranteed according to the manufacturer's description that this value will not be exceeded in use, either by means of the system or, if the system's use is confined to vehicles, providing a corresponding stabilization/limitation of the system's supply, as indicated in the communication form.

Table 25
Class W – Bendlight – Category 2 – System Requirements

Class W – Bendlight Cat. 2		Position/deg					Column A		Column B		Column C		
Tabled requirements expressed in cd		horizontal			vertical		≅ 0% CoP		≅ 20% CoP		≅ 30% CoP		
No	Element	at/	from	to		at		min	max	min	max	min	max
1	B50L	L	3.43			U	0.57		790		960		1045
3	BR	R	2.5			U	1		2650		3180		3445
4	Line BRR	R	8	R	20	U	0.57		5300		6360		6890
5	Line BLL	L	8	L	20	U	0.57		880		1135		1260
7	Line III b	L	4	L	0.5	U	0.34		880		1135		1260

Table 26
Class E – Non-bending mode

Class E - non-bending mode		Position/deg					Column A		Column B		Column C		
Tabled requirements expressed in cd		horizontal			vertical		≅ 0% CoP		≅ 20% CoP		≅ 30% CoP		
No	Element	at/	from	to		at		min	max	min	max	min	max
1	B50L	L	3.43			U	0.57		625		880		1005
3	BR	R	2.5			U	1		1750		2100		2275

Class E - non-bending mode		Position/deg					Column A		Column B		Column C		
Tabled requirements expressed in cd		horizontal			vertical		≅ 0% CoP		≅ 20% CoP		≅ 30% CoP		
No	Element	at/	from	to		at		min	max	min	max	min	max
4	Point BRR	R	8			U	0.57		3550		2100		2275
5	Point BLL	L	8			U	0.57		880		1135		1260
7	Line III b	L	4	L	0.5	U	0.34		880		1135		1260
11	75 R	R	1.15			D	0.57	15200	79300	12160	95160	10640	103090
12	50 V	V				D	0.86	10100	79300	8080	95160	7070	103090
13	50 L	L	3.43			D	0.86	6800	79300 ¹	5440	95160 ¹	4760	103090 ¹

Note to Table 26:

¹ The maximum value may be multiplied by 1.4, if it is guaranteed according to the manufacturer's description that this value will not be exceeded in use, either by means of the system or, if the system's use is confined to vehicles, providing a corresponding stabilization/limitation of the system's supply, as indicated in the communication form.

Table 27

Class E1 – Non-bending mode State

Class E1 – non-bending mode		Position/degrees					Column A		Column B		Column C		
Tabled requirements expressed in cd		horizontal			vertical		≅ 0% CoP		≅ 20% CoP		≅ 30% CoP		
No	Element	at/	from	to		at		min	max	min	max	min	max
1	B50L	L	3.43			U	0.57		530		700		785
3	BR	R	2.5			U	1		1750		2100		2275
4	Point BRR	R	8			U	0.57		3550		2100		2275
5	Point BLL	L	8			U	0.57		880		1135		1260
7	Line III b	L	4	L	0.5	U	0.34		880		1135		1260
11	75 R	R	1.15			D	0.57	15200	70500	12160	84600	10640	91650
12	50 V	V				D	0.86	10100	70500	8080	84600	7070	91650
13	50 L	L	3.43			D	0.86	6800	70500 ¹	5440	84600 ¹	4760	91650 ¹

Note to Table 27:

¹ The maximum value may be multiplied by 1.4, if it is guaranteed according to the manufacturer's description that this value will not be exceeded in use, either by means of the system or, if the system's use is confined to vehicles, providing a corresponding stabilization/limitation of the system's supply, as indicated in the communication form.

Table 28
Class E2 – Non-bending mode

Class E2 – non-bending mode		Position/degrees						Column A		Column B		Column C	
Tabled requirements expressed in cd		horizontal				vertical		± 0% CoP		± 20% CoP		± 30% CoP	
No	Element	at/	from	to		at		min	max	min	max	min	max
1	B50L	L	3.43			U	0.57		440		610		695
3	BR	R	2.5			U	1		1750		2100		2275
4	Point BRR	R	8			U	0.57		3550		2100		2275
5	Point BLL	L	8			U	0.57		880		1135		1260
7	Line III b	L	4	L	0.5	U	0.34		880		1135		1260
11	75 R	R	1.15			D	0.57	15200	61700	12160	74040	10640	80210
12	50 V	V				D	0.86	10100	61700	8080	74040	7070	80210
13	50 L	L	3.43			D	0.86	6800	61700 ¹	5440	74040 ¹	4760	80210 ¹

Note to Table 28:

¹ The maximum value may be multiplied by 1.4, if it is guaranteed according to the manufacturer's description that this value will not be exceeded in use, either by means of the system or, if the system's use is confined to vehicles, providing a corresponding stabilization/limitation of the system's supply, as indicated in the communication form.

Table 29
Class E3 – Non-bending mode

Class E3 - non-bending mode		Position/degrees						Column A		Column B		Column C	
Tabled requirements expressed in cd		horizontal				vertical		± 0% CoP		± 20% CoP		± 30% CoP	
No	Element	at/	from	to		at		min	max	min	max	min	max
1	B50L	L	3.43			U	0.57		350		520		605
3	BR	R	2.5			U	1		1750		2100		2275
4	Point BRR	R	8			U	0.57		3550		2100		2275
5	Point BLL	L	8			U	0.57		880		1135		1260
7	Line III b	L	4	L	0.5	U	0.34		880		1135		1260
11	75 R	R	1.15			D	0.57	15200	52900	12160	63480	10640	68770
12	50 V	V				D	0.86	10100	52900	8080	63480	7070	68770
13	50 L	L	3.43			D	0.86	6800	52900 ¹	5440	63480 ¹	4760	68770 ¹

Note to Table 29:

¹ The maximum value may be multiplied by 1.4, if it is guaranteed according to the manufacturer's description that this value will not be exceeded in use, either by means of the system or, if the system's use is confined to vehicles, providing a corresponding stabilization/limitation of the system's supply, as indicated in the communication form.

Table 30
Class R – Driving – Neutral State – System Requirements

Driving Beam Straight Ahead Test Point	Angular Coordinates (degrees)	Column A		Column B		Column C	
		Required luminous intensity (cd) \triangleq 0% CoP		Required luminous intensity (cd) \triangleq 20% CoP		Required luminous intensity (cd) \triangleq 30% CoP	
		Min	Max	Min	Max	Min	Max
HV	H,V	32,400	215,000	26,000	258,000	23,000	279,500
H-5L	0.0, 5.0 L	5,100	215,000	4,080	258,000	3,570	279,500
H-2.5L	0.0, 2.5 L	20,300	215,000	16,240	258,000	14,210	279,500
H-2.5R	0.0, 2.5 R	20,300	215,000	16,240	258,000	14,210	279,500
H-5R	0.0, 5.0 R	5,100	215,000	4,080	258,000	3,570	279,500

Table 31
Class R – Driving Beam Bendlight – System Requirements

Driving Beam Bendlight Test Point	Angular Coordinates (degrees)	Column A		Column B		Column C	
		Required luminous intensity (cd) \triangleq 0% CoP		Required luminous intensity (cd) \triangleq 20% CoP		Required luminous intensity (cd) \triangleq 30% CoP	
		Min	Max	Min	Max	Min	Max
HV	H,V	32,400	215,000	26,000	258,000	23,000	279,500
H-5L	0.0, 5.0 L	4,080	215,000	3,264	258,000	2,856	279,500
H-2.5L	0.0, 2.5 L	16,240	215,000	12,992	258,000	11,368	279,500
H-2.5R	0.0, 2.5 R	16,240	215,000	12,992	258,000	11,368	279,500
H-5R	0.0, 5.0 R	4,080	215,000	3,264	258,000	2,856	279,500

Table 32
Class R – Adaptive Driving Beam – COP Values

Part A	Test Point	Position/Deg.		Column A Max. Intensity** \triangleq 0% CoP	Column B Max. Intensity** \triangleq 20% CoP	Column C Max. Intensity** \triangleq 30% CoP
		Horizontal	Vertical	(cd)	(cd)	(cd)
		Line 1 Left Oncoming vehicle at 50 m in the case of Right- Hand Traffic	4.8°L to 2°L	0.57°Up	625	880
Line 1 Right Oncoming vehicle at 50 m in the case of Left-Hand Traffic	2°R to 4.8°R	0.57°Up	625	880	1003	
Line 2 Left Oncoming vehicle at 100 m in the case of Right- Hand Traffic	2.4°L to 1°L	0.3°Up	1750	2100	2275	
Line 2 Right Oncoming vehicle at 100 m in the case of Left-	1°R to 2.4°R	0.3°Up	1750	2100	2275	

Part A	Test Point	Position/Deg.		Column A Max. Intensity** ± 0% CoP	Column B Max. Intensity** ± 20% CoP	Column C Max. Intensity** ± 30% CoP
		Horizontal	Vertical	(cd)	(cd)	(cd)
	Hand Traffic					
	Line 3 Left Oncoming vehicle at 200 m in the case of Right- Hand Traffic	1.2°L to 0.5°L	0.15°Up	5450	6540	7085
	Line 3 Right Oncoming vehicle at 200 m in the case of Left- Hand Traffic	0.5°R to 1.2°R	0.15°Up	5450	6540	7085
	Line 4 Preceding vehicle at 50 m in the case of Right- Hand Traffic	1.7°L to 1.0°R	0.3°Up	1850	2220	2405
		>1.0°R to 1.7°R		2500	3000	3250
	Line 4 Preceding vehicle at 50 m in the case of Left-Hand Traffic	1.7°R to 1.0°L		1850	2220	2405
		>1.0°L to 1.7°L		2500	3000	3250
	Line 5 Preceding vehicle at 100 m in the case of Right- Hand Traffic	0.9°L to 0.5°R	0.15°Up	5300	6360	6890
		>0.5°R to 0.9°R		7000	8400	9100
	Line 5 Preceding vehicle at 100 m in the case of Left- Hand Traffic	0.9°R to 0.5°L		5300	6360	6890
		>0.5°L to 0.9°L		7000	8400	9100
	Line 6 Preceding vehicle at 200 m in the case of Left- Hand Traffic and Right-Hand Traffic	0.45°L to 0.45°R	0.1°Up	16000	19200	20800

Part B	Test Point	Position /degrees*		Column A Min. Intensity**± 0% CoP	Column B Min. Intensity**± 20% CoP	Column C Min. Intensity**± 30% CoP
		Horizontal	Vertical	(cd)	(cd)	(cd)
	50R	1.72 R	D 0.86	5 100	4080	3570
	50V	V	D 0.86	5 100	4080	3570
	50L	3.43 L	D 0.86	2 550	2040	1785
	25LL	16 L	D 1.72	1 180	944	826
	25RR	11 R	D 1.72	1 180	944	826

Notes to Table 32

* Angular positions are indicated for right-hand traffic.

** The photometric requirements for each single measuring point (angular position) of this lighting function apply to half of the sum of the respective measured values from all lighting units of the system applied for this function.

Each of the lines defined in part A of Table 32, in conjunction with the test points as prescribed in part B of Table 32 shall be measured individually corresponding to the signal provided by the signal generator.

In the case where the passing beam, which meets the requirements of paragraph 5.3.6.2., is continuously operated in conjunction with the adaptation of the driving beam, the photometric requirements in Part B of Table 32 shall not be applied.

5.4. Technical requirements concerning headlamps to provide a passing-beam of the Class AS, BS, CS, DS and ES (symbols "C-AS", "C-BS", "WC-CS", "WC-DS" and "WC-ES")

5.4.1. Aiming procedure

5.4.1.1. For a correct aiming the passing beam shall produce a sufficiently sharp "cut-off" to permit a satisfactory visual adjustment with its aid as indicated in paragraph 1 of Annex 6. The aiming shall be carried out using a flat vertical screen set up at a distance of 10 or 25 m forward of the headlamp and at right angles to the H-V. The screen shall be sufficiently wide to allow examination and adjustment of the "cut-off" of the passing beam over at least 3° on either side of the V-V line. The "cut-off" shall be substantially horizontal and shall be as straight as possible from at least 3° L to 3° R.

5.4.1.2. The headlamp shall be aimed according to paragraph 3. of Annex 6.

If, however, vertical adjustment cannot be performed repeatedly to the required position within the allowed tolerances, the instrumental method of Annex 6, paragraphs 4 and 5 shall be applied to test compliance with the required minimum quality of the "cut-off" line and to perform the beam vertical adjustment.

5.4.2. When so aimed, the headlamp must, if its approval is sought solely for provision of a passing beam¹⁰, comply with the requirements set out in paragraphs 5.4.4.; if it is intended to provide both a passing beam and a driving beam, it shall comply with the requirements set out in paragraphs 5.4.4. and 5.1.

5.4.3. Where a headlamp so aimed does not meet the requirements set out in paragraphs 5.4.4. and 5.1., its alignment may be changed, except for headlamps that have no mechanism to adjust horizontal aim, on condition that the axis of the beam is not displaced laterally by more than 0.5 degree to the right or left and vertically by not more than 0.25 degree up or down. To facilitate alignment by means of the "cut-off", the headlamp may be partially occulted in order to sharpen the "cut-off". However, the "cut-off" should not extend beyond the line H-H.

5.4.4. The passing beam shall meet the requirements as shown in the applicable table below and the applicable figure as shown in Annex 4.

¹⁰ Such a special "passing beam" headlamp may incorporate a driving beam not subject to requirements.

Notes:

For Class ES headlamps the voltage applied to the terminals of the ballast(s) is either $13.2\text{ V} \pm 0.1\text{ V}$ for 12 V systems or as otherwise specified (see Annex 12).

"D" means under the H-H line.

"U" means above the H-H line.

"R" means right of the V-V line.

"L" means left of the V-V line.

5.4.4.1. For Class AS headlamps (Figure A4-VIII in Annex 4):

Table 33

Passing-beam Class AS

<i>Test point / line / zone</i>	<i>Angular coordinates - degrees*</i>		<i>Required luminous intensity in cd</i>
Any point in Zone 1	0° to 15°U	5°L to 5°R	≤ 320 cd
Any point on line 25L to 25R	1.72°D	5°L to 5°R	≥ 1,100 cd
Any point on line 12.5L to 12.5R	3.43°D	5°L to 5°R	≥ 550 cd

Note to Table 33

* 0.25° tolerance allowed independently at each test point for photometry unless indicated otherwise.

5.4.4.2. For Class BS headlamps (Figure A4-IX in Annex 4):

Table 34

Passing-beam Class BS

<i>Test/point/ line/zone</i>	<i>Angular coordinates - degrees*</i>		<i>Required luminous intensity in cd</i>
Any point in Zone 1	0° to 15°U	5°L to 5°R	≤ 700 cd
Any point on line 50L to 50R except 50V	0.86°D	2.5°L to 2.5°R	≥ 1,100 cd
Point 50V	0.86°D	0	≥ 2,200 cd
Any point on line 25L to 25R	1.72°D	5°L to 5°R	≥ 2,200 cd
Any point in Zone 2	0.86°D to 1.72°D	5°L to 5°R	≥ 1,100 cd

Note to Table 34

* 0.25° tolerance allowed independently at each test point for photometry unless indicated otherwise.

5.4.4.3. For Class CS, DS or ES headlamp (Figure A4-X in Annex 4):

Table 35
Passing-beam Class CS, DS or ES

Test point / line / zone	Test point angular coordinates degrees*		Required luminous intensity in cd				
			Minimum			Maximum	
			Class CS	Class DS	Class ES	Classes CS,DS,ES	
1	0.86°D	3.5°R	2,000	2,000	2,500	13,750	
2	0.86°D	0	2,450	4,900	4,900	-	
3	0.86°D	3.5°L	2,000	2,000	2,500	13,750	
4	0.50°U	1.50°L and 1.50°R	--	--	--	900	
5	2.00°D	15°L and 15°R	550	1,100	1,100	--	
6	4.00°D	20°L and 20°R	150	300	600	-	
7	0	0	--	--	--	1,700	
Line 1	2.00°D	9°L to 9°R	1,350	1,350	1,900	-	
8**	4.00°U	8.0°L	$\sum 8 + 9 + 10 \geq 150 \text{ cd}^{**}$				700
9**	4.00°U	0					700
10**	4.00°U	8.0°R					700
11**	2.00°U	4.0°L	$\sum 11 + 12 + 13 \geq 300 \text{ cd}^{**}$				900
12**	2.00°U	0					900
13**	2.00°U	4.0°R					900
14**	0	8.0°L and 8.0°R	50 cd**	50 cd**	50 cd**	-	
15**	0	4.0°L and 4.0°R	100 cd**	100 cd**	100 cd**	900	
Zone 1	1°U/8°L-4°U/8°L-4°U/8°R- 1°U/8°R-0/4°R-0/1°R-0.6°U/0- 0/1°L-0/4°L-1°U/8°L		--	--	--	900	
Zone 2	>4U to <15 U	8°L to 8°R	--	--	--	700	

Notes to Table 35

* 0.25° tolerance allowed independently at each test point for photometry unless indicated otherwise.

** On request of the applicant during measurement of these points, the front position lamp approved to UN Regulation No. 50, UN Regulation No. 7 or UN Regulation No. [LSD]; if combined, grouped, or reciprocally incorporated-shall be switched ON.

- 5.4.4.4. The light shall be as evenly distributed as possible within zones 1 and 2 for Class CS, DS or ES headlamps.
- 5.4.4.5. Either one or two filament light sources (Classes AS, BS, CS, DS) or one gas discharge light source (Class ES) or one or more LED light source(s) or LED module(s) (Classes AS, BS, CS, DS, ES) are permitted for the passing beam.
- 5.4.5. Additional light source(s) and/or additional lighting unit(s) used to produce bend lighting is (are) permitted for vehicles of categories L and T, provided that:

- 5.4.5.1. The following requirement regarding illumination shall be met, when the principal passing beam(s) and corresponding additional light source(s) used to produce bend lighting are activated simultaneously:
- (a) Left bank (when the motorcycle is rotated to the left about its longitudinal axis) the luminous intensity values shall not exceed 900cd in the zone extending from HH to 15 deg above HH and from VV to 10 deg left.
 - (b) Right bank (when the motorcycle is rotated to the right about its longitudinal axis) the luminous intensity values shall not exceed 900cd in the zone extending from HH to 15 deg above HH and from VV to 10 deg right.
- 5.4.5.2. This test shall be carried out with the minimum bank angle specified by the applicant simulating the condition by means of the test fixture etc.
- 5.4.5.3. For this measurement, at the request of the applicant, principal passing beam and additional light source(s) used to produce bend lighting, may be measured individually and the photometric values obtained combined to determine compliance with the specified luminous intensity values.
- 5.5. Technical requirements concerning front fog lamps of the Class F3 (symbol "F3")
- 5.5.1. Photometric adjustment and measuring conditions
- 5.5.1.1. The front fog lamp shall be aimed according to Annex 6 paragraph 3.
- If, however, vertical adjustment cannot be performed repeatedly to the required position within the allowed tolerances, the instrumental method of Annex 6, paragraphs 4. and 5. shall be applied to test compliance with the required minimum quality of the "cut-off" line and to perform the beam vertical adjustment.
- 5.5.1.2. The front fog lamp shall meet the requirements as shown in Table 36 and Figure A4-XI in Annex 4.
- 5.5.2. Photometric requirements
- When so adjusted, the front fog lamp shall meet the photometric requirements in Table 36 (refer also to Figure A4-XI of Annex 4):

Table 36

Type approval photometric requirements for front fog lamp

<i>Designated lines or zones</i>	<i>Vertical position* above h + below h -</i>	<i>Horizontal position* left of v: - right of v: +</i>	<i>Luminous intensity (in cd)</i>	<i>To comply</i>
Point 1, 2**	+60°	±45°	85 max	All points
Point 3, 4**	+40°	±30°		
Point 5, 6**	+30°	±60°		
Point 7, 10**	+20°	±40°		
Point 8, 9**	+20°	±15°		
Line 1**	+8°	-26° to +26°	130 max	All line
Line 2**	+4°	-26° to +26°	150 max	All line

<i>Designated lines or zones</i>	<i>Vertical position* above h + below h -</i>	<i>Horizontal position* left of v: - right of v: +</i>	<i>Luminous intensity (in cd)</i>	<i>To comply</i>
Line 3	+2°	-26° to +26°	245 max	All line
Line 4	+1°	-26° to +26°	360 max	All line
Line 5	0°	-10° to +10°	485 max	All line
Line 6 ***	-2.5°	-10° to +10°	2700 min	All line
Line 7 ***	-6.0°	-10° to +10°	< 50 per cent of max. on line 6	All line
Line 8L and R***	-1.5° to -3.5°	-22° and +22°	1,100 min	One or more points
Line 9L and R***	-1.5° to -4.5°	-35° and +35°	450 min	One or more points
Zone D***	-1.5° to -3.5°	-10° to +10°	12,000 max	Whole zone

Notes to Table 36

* The co-ordinates are specified in degrees for an angular web with a vertical polar axis.

** See paragraph 5.5.2.4.

*** See paragraph 5.5.2.2.

- 5.5.2.1. The luminous intensity shall be measured either with white light or coloured light as prescribed by the applicant for use of the fog lamp in normal service. Variations in homogeneity detrimental to satisfactory visibility in the zone above the line 5 from 10 degrees left to 10 degrees right are not permitted.
- 5.5.2.2. At the request of the applicant, two front fog lamps constituting a matched pair corresponding to paragraph 3.3.2.4.3. may be tested separately. In this case the specified requirements for lines 6, 7, 8, 9 and the Zone D in Table 36 apply to half the sum of readings of the right-hand and left-hand side front fog lamp. However each of the two front fog lamps shall meet at least 50 per cent of the minimum value required for line 6. Additionally, each of the two front fog lamps that constitute the matched pair are only required to meet the requirements of line 6 and line 7 from 5° inwards to 10° outwards.
- 5.5.2.3. Inside the field between lines 1 to 5 in Figure A4-XI of Annex 4, the beam pattern should be substantially uniform. Discontinuities in intensities detrimental to satisfactory visibility between the lines 6, 7, 8 and 9 are not permitted.
- 5.5.2.4. In the light-distribution as specified in Table 36, single narrow spots or stripes inside the area including the measuring points 1 to 10 and line 1 or inside the area of line 1 and line 2 with not more than 175 cd are allowed, if not extending beyond a conical angle of 2° aperture or a width of 1°. If multiple spots or stripes are present they shall be separated by a minimum angle of 10°.
- 5.5.2.5. If the specified luminous intensity requirements are not met, a re-aim of the cut-off position within $\pm 0.5^\circ$ vertical and/or $\pm 2^\circ$ horizontal is allowed. In the re-aimed position all photometric requirements shall be met.
- 5.5.3. Other photometric requirements
- 5.5.3.1. In the case of front fog lamps equipped with gas-discharge light sources with the ballast not integrated with the light source, the luminous intensity shall exceed 1,080 cd in the measuring point at 0° horizontal and 2° D vertical four

seconds after activation of the fog lamp which has not been operated for 30 minutes or more.

5.5.3.2. To adapt to dense fog or similar conditions of reduced visibility, it is permitted to automatically vary the luminous intensities provided that:

- (a) An active electronic light source control gear is incorporated into the front fog lamp function system;
- (b) All intensities are varied proportionately.

The system, when checked for compliance according to the provisions of paragraph 4.6.6., is considered acceptable if the luminous intensities remain within 60 per cent and 100 per cent of the values specified in Table 36.

5.5.3.2.1. An indication shall be inserted in the communication form (Annex 1, item 9).

5.5.3.2.2. The Technical Service responsible for type approval shall verify that the system provides automatic modifications, such that good road illumination is achieved and no discomfort is caused to the driver or to other road users.

5.5.3.2.3. Photometric measurements shall be performed according to the applicant's description.

5.5.4. Tolerance requirements for conformity of production control procedure:

5.5.4.1. When testing the photometric performances of any front fog lamp chosen at random according to paragraph 5.5., no measured value of the luminous intensity may deviate unfavourably by more than 20 per cent

5.5.4.2. For the measured values in Table 36 the respective maximum deviations may be:

Table 37

Conformity of production, photometric requirements for front fog lamp

Designated lines or zones	Vertical position* above h + below h -	Horizontal position* left of v: - right of v: +	Luminous intensity candela		To comply
			Equivalent 20 per cent	Equivalent 30 per cent	
Point 1, 2**	+60°	±45°	115 max	130 max	All points
Point 3, 4**	+40°	±30°			
Point 5, 6**	+30°	±60°			
Point 7, 10**	+20°	±40°			
Point 8, 9**	+20°	±15°			
Line 1**	+8°	-26° to +26°	160 max	170 max	All line
Line 2**	+4°	-26° to +26°	180 max	195 max	All line
Line 3	+2°	-26° to +26°	295 max	320 max	All line
Line 4	+1°	-26° to +26°	435 max	470 max	All line
Line 5	0°	-10° to +10°	585 max	630 max	All line
Line 6***	-2.5°	from 5° inwards to 10° outwards	2,160 min	1,890 min	All line
Line 8 L and R***	-1.5° to -3.5°	-22° and +22°	880 min	770 min	One or more points
Line 9 L and R***	-1.5° to -4.5°	-35° and +35°	360 min	315 min	One or more points
Zone D	-1.5° to -3.5 °	-10° to +10°	14,400 max	15,600 max	Whole zone

Note to Table 37:

- * The co-ordinates are specified in degrees for an angular web with a vertical polar axis.
 - ** See paragraph 5.5.2.4.
 - *** See paragraph 5.5.2.2.
- 5.6. Technical requirements concerning cornering lamps (symbol K)
- 5.6.1. Intensity of light emitted
- 5.6.1.1. For the left-hand device, the minimum intensity of the light at the specified measuring points shall be as follows:
- (a) 2.5D – 30L: 240 cd
 - (b) 2.5D – 45L: 400 cd
 - (c) 2.5D – 60L: 240 cd
- The same values apply symmetrically for a right-hand device. (Shown in Annex 4 Figure A4-XII)
- 5.6.1.2. The intensity of the light emitted in all directions shall not exceed:
- (a) 300 cd above the 1.0U, L and R line;
 - (b) 600 cd between the horizontal plane and the 1.0U, L and R Line; and
 - (c) 14,000 cd below the 0.57 D, L and R line.
- 5.6.1.3. In the case of a single lamp containing more than one light source when all light sources are illuminated the maximum intensities shall not be exceeded.
- 5.6.1.4. Failure of a single lamp containing more than one light source:
- 5.6.1.4.1. In a single lamp containing more than one light source, a group of light sources, wired so that the failure of any one of them causes all of them to stop emitting light, shall be considered to be one light source.
- 5.6.1.4.2. In case of failure of any one light source in a single lamp containing more than one light source, at least one of the following provisions shall apply:
- (a) The light intensity complies with the minimum intensity required in the table of standard light distribution in space as shown in Annex 4, Figure L; or
 - (b) A signal for activation of a tell-tale indicating failure, as indicated in paragraph 6.20.8. of Regulation No. 48, is produced, provided that the luminous intensity at 2.5°D 45°L for a left-side lamp (the L angle should be substituted for the R angle for a right-side lamp) is at least 50 per cent of the minimum intensity required. In this case a note in the communication form states that the lamp is only for use on a vehicle fitted with a tell-tale indicating failure.
- 5.6.2. Measurement methods
- 5.6.2.1. When photometric measurements are taken, stray reflections shall be avoided by appropriate masking.
- 5.6.2.2. In the event that the results of measurements are challenged, measurements shall be taken in such a way as to meet the following requirements:
- 5.6.2.2.1. The distance of measurement shall be such that the law of the inverse of the square of the distance is applicable;

- 5.6.2.2.2. The measuring equipment shall be such that the angle subtended by the receiver from the reference centre of the light is between $10'$ and 1° ;
- 5.6.2.2.3. The intensity requirement for a particular direction of observation shall be satisfied if the required intensity is obtained in a direction deviating by not more than one quarter of a degree from the direction of observation.
- 5.6.2.3. Measuring points expressed in degrees of angle with the axis of reference are shown in Annex 4, Figure A4-XII.
- The values shown in the table give, for the various directions of measurement, the minimum intensities in cd.
- 5.6.2.4. Horizontal and vertical angles for the field of geometric visibility are shown in Annex 4, Figures A4-XIII. The directions $H = 0^\circ$ and $V = 0^\circ$ correspond to the axis of reference. On the vehicle they are horizontal, parallel to the median longitudinal plane of the vehicle and oriented in the required direction of visibility. They pass through the centre of reference.
- 5.6.3. Photometric measurement of lamps equipped with several light sources. The photometric performance shall be checked:
- 5.6.3.1. In case of non-replaceable light sources, with the light sources present in the lamp, in accordance with paragraph 4.6.
- 5.6.3.2. In case of replaceable light sources, in addition to paragraph 4.6.
- The luminous intensity values produced shall be corrected.
- (a) For filament light sources the correction factor is the ratio between the reference luminous flux and the mean value of the luminous flux found at the voltage applied (13.2 V or 13.5 V);
- (b) For LED light sources the correction factor is the ratio between the objective luminous flux and the mean value of the luminous flux found at the voltage applied (6.75 V, 13.5 V or 28.0 V).
- The actual luminous fluxes of each light source used shall not deviate more than ± 5 per cent from the mean value. Alternatively and in case of filament light sources only, a standard filament light source may be used in turn, in each of the individual positions, operated at its reference flux, the individual measurements in each position being added together.
- 5.6.3.3. For any cornering lamp except those equipped with filament light source(s), the luminous intensities, measured after one minute and after 10 minutes of operation, shall comply with the minimum and maximum requirements. The luminous intensity distributions after one and after 10 minutes of operation shall be calculated from the luminous intensity distribution measured after photometric stability has occurred by applying at each test point the ratio of luminous intensities measured at $45^\circ L 2.5^\circ D$ for a left-side lamp (the L angle should be substituted for the R angle for a right-side lamp):
- (a) After one minute;
- (b) After 10 minutes; and
- (c) After photometric stability has occurred.
- Photometric stability has occurred means the variation of the luminous intensity for the specified test point is less than 3 per cent within any 15 minute period.

6. Transitional provisions

6.1. General

- 6.1.1. Contracting Parties applying this Regulation shall continue to accept type approvals of the lamps (functions), to any of the preceding series of amendments to this Regulation, which are not affected by the changes introduced by the latest series of amendments.

To verify this, the change index applicable to the pertinent lamp (function) shall not differ from its change index as indicated in the latest series of amendments.

- 6.1.2. Contracting Parties applying this Regulation shall not refuse to grant extensions to type approvals according to any preceding series of amendments to this Regulation.

Annex 1

Communication

(Maximum format: A4 (210 x 297 mm))

issued by: Name of administration:



Concerning:² Approval granted
 Approval extended
 Approval refused
 Approval withdrawn
 Production definitively discontinued

of a type of device or system pursuant to UN Regulation No. [RID]

Class of the device: Change index:

Approval No.

Unique Identifier (UI) (If applicable):

1. Trade name or mark of the device or system:
2. Manufacturer's name for the type of device or system:

3. Manufacturer's name and address:.....

4. If applicable, name and address of manufacturer's representative:

5. Submitted for approval on:
6. Technical Service responsible for conducting approval tests:
7. Date of report issued by that service:
8. Number of report issued by that service:
9. Brief description:
 9.1. For Headlamps of Classes A and B¹

¹ Distinguishing number of the country which has granted/extended/refused/withdrawn approval (see approval provisions in the regulation).

² Strike out what does not apply.

- 9.1.1. Category as described by the relevant marking:³
- 9.1.2. Number, category and kind of light source(s):
- 9.1.3. Reference luminous flux used for the principal passing-beam (lm):
- 9.1.4. Principal passing-beam operated at approximately (V):
- 9.1.5. Measures according to paragraph 4.12. of this Regulation:
- 9.1.6. Number and specific identification code(s) of LED module(s) and for each LED module a statement whether it is replaceable or not: yes/no¹
- 9.1.7. Number and specific identification code(s) of electronic light source control gear(s).....
- 9.1.8. Total objective luminous flux as described in paragraph 4.5.6. of this Regulation exceeds 2,000 lumens: yes/no/does not apply¹
- 9.1.9. The adjustment of the cut-off has been determined at: 10 m/25 m/does not apply¹
The determination of the minimum sharpness of the "cut-off" has been carried out at: 10 m/25 m/does not apply¹
- 9.2. For headlamps of Class D
 - 9.2.1. Headlamp/system submitted for approval as type:⁴
 - 9.2.2. The passing beam light source may/may not¹ be lit simultaneously with the driving beam light source and/or another reciprocally incorporated headlamp.
 - 9.2.3. The rated voltage of the device is:.....
 - 9.2.4. Number, category and kind of light source(s):
 - 9.2.4.1. If more than one objective luminous flux value is specified:
Objective luminous flux value used for the principal passing beam [lm]

³ Indicate the appropriate marking selected from the list below:

- C, $\begin{matrix} \rightarrow \\ \leftrightarrow \end{matrix}$ C, R, R PL, CR, $\begin{matrix} \rightarrow \\ \leftrightarrow \end{matrix}$ CR, C/R, $\begin{matrix} \rightarrow \\ \leftrightarrow \end{matrix}$ C/R, C/, $\begin{matrix} \rightarrow \\ \leftrightarrow \end{matrix}$ C/, C/,
- C, PL, $\begin{matrix} \rightarrow \\ \leftrightarrow \end{matrix}$ C PL, CR PL, $\begin{matrix} \rightarrow \\ \leftrightarrow \end{matrix}$ CR PL, C/R PL, $\begin{matrix} \rightarrow \\ \leftrightarrow \end{matrix}$ C/R PL, C/PL, $\begin{matrix} \rightarrow \\ \leftrightarrow \end{matrix}$ C/PL, C/PL
- HC, HC, $\begin{matrix} \rightarrow \\ \leftrightarrow \end{matrix}$ HC, HR, HR PL, HCR, $\begin{matrix} \rightarrow \\ \leftrightarrow \end{matrix}$ HCR, HC/R, $\begin{matrix} \rightarrow \\ \leftrightarrow \end{matrix}$ HC/R, HC/, $\begin{matrix} \rightarrow \\ \leftrightarrow \end{matrix}$ HC/, HC/,
- HC PL, $\begin{matrix} \rightarrow \\ \leftrightarrow \end{matrix}$ HC PL, HCR PL, $\begin{matrix} \rightarrow \\ \leftrightarrow \end{matrix}$ HCR PL, HC/R PL, $\begin{matrix} \rightarrow \\ \leftrightarrow \end{matrix}$ HC/R PL, HC/PL, $\begin{matrix} \rightarrow \\ \leftrightarrow \end{matrix}$ HC/PL, HC/PL

⁴ Indicate the appropriate marking selected from the list below:

- DC, DC/, DC/PL, DR, DCR, DC/R, DC PL, DR PL, DCR DC/R
- DC, DCR, DC/R, DC/, DC PL, DCR PL,DC/R DC/PL, PL, PL,
- $\begin{matrix} \rightarrow \\ \leftrightarrow \end{matrix}$ $\begin{matrix} \rightarrow \\ \leftrightarrow \end{matrix}$ $\begin{matrix} \rightarrow \\ \leftrightarrow \end{matrix}$ $\begin{matrix} \rightarrow \\ \leftrightarrow \end{matrix}$ $\begin{matrix} \rightarrow \\ \leftrightarrow \end{matrix}$ PL, $\begin{matrix} \rightarrow \\ \leftrightarrow \end{matrix}$
- DC, DCR, DC/R, DC/, DC PL, DCR PL,DC/R DC/PL,
- $\begin{matrix} \leftrightarrow \\ \leftrightarrow \end{matrix}$ $\begin{matrix} \leftrightarrow \\ \leftrightarrow \end{matrix}$ $\begin{matrix} \leftrightarrow \\ \leftrightarrow \end{matrix}$ $\begin{matrix} \leftrightarrow \\ \leftrightarrow \end{matrix}$ $\begin{matrix} \leftrightarrow \\ \leftrightarrow \end{matrix}$ PL, $\begin{matrix} \leftrightarrow \\ \leftrightarrow \end{matrix}$

- 9.2.4.2. If more than one objective luminous flux value is specified:
Objective luminous flux value used for the driving beam..... [lm]
- 9.2.5. Trade name and identification number of separate ballast(s) or part(s) of ballast(s):
- 9.2.6. The adjustment of the "cut-off" has been determined at 10 m/25 m.¹
The determination of the minimum sharpness of the "cut-off" has been carried out at 10 m/25 m.¹
- 9.2.7. Number and specific identification code(s) of LED module(s):.....
- 9.2.8. Distributed lighting system with one common gas-discharge light source:
Yes/No¹
- 9.2.9. Remarks (if any):.....
- 9.2.10. Measures according to paragraph 4.12. of this Regulation:
- 9.3. For AFS – Systems
- 9.3.1. Category as described by the relevant marking⁵
- 9.3.2. Number, category and kind of light source(s)
- 9.3.2.1. Number and specific identification code(s) of LED module(s) and for each LED module a statement whether it is replaceable or not: yes/no¹
.....
- 9.3.2.2. Number and specific identification code(s) of electronic light source control gear(s), if applicable
- 9.3.2.3. Total objective luminous flux as described in paragraph 4.5.2.6. of this Regulation exceeds 2,000 lumen: yes/no¹
- 9.3.3. (a) Indications according to paragraph 5.3.5.1. of this Regulation (which lighting unit(s) provide a "cut-off" as defined in Annex 5 of this Regulation, that projects into a zone extending from 6 degrees left to 4 degrees right and upwards from a horizontal line positioned at 0.8 degree down)
- (b) The adjustment of the "cut-off" has been determined at 10 m / 25 m¹
- (c) The determination of the minimum sharpness of the "cut-off" has been carried out at 10 m / 25 m¹
- 9.3.4. The vehicle(s) for which the system is intended as original equipment
- 9.3.5. Whether approval is sought for a system which is not intended to be included as part of the approval of a vehicle type according to UN Regulation No. 48:
yes/no¹
- 9.3.5.1. If in the affirmative: information sufficient to identify the vehicle(s) for which the system is intended.....

⁵ Indicate the appropriate marking as foreseen according to this Regulation for each installation unit or assembly of installation units.

- 9.3.6. Indications according to paragraph 5.3.5.2. of this Regulation (which class E passing beam mode(s), if any, comply with a "data set" of Table 14 of this Regulation)
- 9.3.7. Whether approval is sought for a system intended to be installed on vehicles only, which provide means for a stabilization/limitation of the system's supply: yes/no¹
- 9.3.8. The adjustment of the "cut-off" has been determined at 10 m / 25 m.¹
The determination of the minimum sharpness of the "cut-off" has been carried out at 10 m / 25 m.¹
- 9.3.9. The system is designed to provide passing beams of :⁶
- 9.3.9.1. Class C Class V Class E Class W
- 9.3.9.2. With the following mode(s), identified by the designation(s), if it applies¹⁴
Mode No. C 1 Mode No. V ... Mode No. E ... Mode No. W ...
Mode No. C ... Mode No. V ... Mode No. E ... Mode No. W ...
Mode No. C ... Mode No. V ... Mode No. E ... Mode No. W ...
- 9.3.9.3. Where the lighting units indicated below are energized^{5,7,8} for the mode No.
- (a) If no bend lighting applies:
Left side No.1 No.3 No.5 No.7 No. 9 No.11
Right side No.2 No.4 No.6 No.8 No.10 No.12
- (b) If bend lighting of category 1 applies:
Left side No.1 No.3 No.5 No.7 No. 9 No.11
Right side No.2 No.4 No.6 No.8 No.10 No.12
- (c) if bend lighting of category 2 applies:
Left side No.1 No.3 No.5 No.7 No. 9 No.11
Right side No.2 No.4 No.6 No.8 No.10 No.12
- Note:* Indications according to paragraph (a) through (c) above are needed additionally for each further mode.
- 9.3.9.4. The lighting units marked below are energized, when the system is in its neutral state^{5,7}
Left side No.1 No.3 No.5 No.7 No. 9 No.11
Right side No.2 No.4 No.6 No.8 No.10 No.12
- 9.3.9.5. The lighting units marked below are energized, when the system is in its traffic change function^{5,6,7}
- (a) If no bend lighting applies:
Left side No.1 No.3 No.5 No.7 No. 9 No.11
Right side No.2 No.4 No.6 No.8 No.10 No.12

⁶ Mark with an X where applicable.
⁷ To be extended if more modes are provided.
⁸ To be continued if more units are provided.

- (b) If bend lighting of category 1 applies:
 Left side No.1 No.3 No.5 No.7 No. 9 No.11
 Right side No.2 No.4 No.6 No.8 No.10 No.12
- (c) If bend lighting of category 2 applies:
 Left side No.1 No.3 No.5 No.7 No. 9 No.11
 Right side No.2 No.4 No.6 No.8 No.10 No.12

9.3.10. The system is designed to provide a main beam^{5, 6, 7}:

9.3.10.1. Yes No

9.3.10.2. With the following mode(s), identified by the designation(s), if it applies:

- Main beam mode No. M 1
 Main beam mode No. M ...
 Main beam mode No. M ...

9.3.10.3. Where the lighting units marked below are energized, for mode No.

- (a) If no bend lighting applies:
 Left side No.1 No.3 No.5 No.7 No. 9 No.11
 Right side No.2 No.4 No.6 No.8 No.10 No.12
- (b) If bend lighting applies:
 Left side No.1 No.3 No.5 No.7 No. 9 No.11
 Right side No.2 No.4 No.6 No.8 No.10 No.12

Note: Indications according to this paragraph (a) through (b) above are needed additionally for each further mode.

9.3.10.4. The lighting units marked below are energized, when the system is in its neutral state^{6,8}

- Left side No.1 No.3 No.5 No.7 No. 9 No.11
 Right side No.2 No.4 No.6 No.8 No.10 No.12

9.3.10.5. The system is designed to provide an adaptation of the driving beam for:

- Right-Hand and Left-Hand traffic: yes no
 Right-Hand traffic only: yes no
 Left-Hand traffic only: yes no

9.4. For headlamps of Classes AS, BS, CS, DS and ES¹

9.4.1. Category as described by the relevant marking⁹:

⁹ Indicate the appropriate marking selected from the list below:

C-AS,	C- BS,	R- BS,	CR- BS,	C/ -BS,	C/R-BS,
	C-BS PL,	R-BS PL,	CR-BS PL,	C/ -BS PL,	C/R-BS PL,
WC-CS,	WC-DS,	WR-CS	WR-DS,	WCR-CS,	WCR-DS,
WC/-CS,	WC/-DS,	WC/R-CS,	WC/R-DS,	WC-CS PL,	
WC-DS PL,	WR-CS PL,	WR-DS PL,	WCR-CS PL,	WCR-DS PL,	

- 9.4.2. Number, category and kind of light source(s), if any:
- 9.4.3. Number and specific identification code(s) of LED modules and for each LED module a statement whether it is replaceable or not: yes/no¹
- 9.4.4. Number and specific identification code(s) of electronic light source control gear(s), if any:
- 9.4.5. The determination of "cut-off" sharpness yes / no¹
If yes, it was carried out at 10 m / 25 m¹
- 9.4.6. Trade name and identification number of separate ballast(s) or part(s) of ballast(s):
- 9.4.7. The passing beam light source may/may not¹ be lit simultaneously with the driving beam light source and/or another reciprocally incorporated headlamp.
- 9.4.8. The minimum bank angle(s) to satisfy the requirement of paragraph 5.4.5.2., if any
- 9.4.9. Primary Driving Beam: yes / no¹
Secondary Driving Beam: yes / no¹
The Secondary Driving Beam shall only be operated together with a passing beam or a primary driving beam.
- 9.5. For front fog lamps Class F3
- 9.5.1. Class as described by the relevant marking:
(F3, F3/, F3PL, F3/PL).....
- 9.5.2. Number, category and kind of light source(s):
- 9.5.3. LED module: yes/no¹ and for each LED module a statement whether it is replaceable or not: yes/no¹
- 9.5.4. LED module specific identification code:
- 9.5.5. Application of electronic light source control gear:¹⁰ yes/no¹
Supply to the light source:
- Specification of the light source control gear:
- Input voltage:¹¹
- In the case of an electronic light source control gear not being part of the lamp:
Output signal specification:

WC/CS PL,	WC/-DS PL,	WC/R-CS PL,	WC/R-DS PL,		
WC+CS,	WC+DS,	WC+R-CS,	WC+R-DS,	C+BS,	C+R-BS,
WC+CS PL,	WC+DS PL,	WC+R-CS PL,	WC+R-DS PL,	C+BS PL,	C+R-BS PL
WC-ES,	WR-ES,	WCR-ES,	WC/-ES,	WC/R-ES,	WC-ES PL,
WR-ES PL,	WCR-ES PL,	WC/-ES PL,	WC/R-ES PL		
WC+ES,	WC+R-ES,	WC+ES PL,	WC+R-ES PL		

¹⁰ The voltage specifications shall include the tolerances or voltage range as specified by the manufacturer and verified by this approval.

¹¹ The parameters of the input voltage including duty cycle, frequency, pulse shape and peak voltage shall be included.

- 9.5.6. Colour of light emitted: white/selective yellow¹
- 9.5.7. Luminous flux of the light source (see paragraph 4.5.2.6.)
greater than 2,000 lumens: ... yes/no¹
- 9.5.8. Luminous intensity is variable: ... yes/no¹
- 9.5.9. The determination of the cut-off gradient (if measured)
was carried out at 10 m / 25 m¹
- 9.6. For cornering lamps
- 9.6.1. Number, category and kind of light source(s):¹².....
- 9.6.2. Voltage and wattage:
- 9.6.3. Light source module: yes/no¹
- 9.6.4. Light source module specific identification code:.....
- 9.6.5. Application of an electronic light source control gear:
- (a) Being part of the lamp..... yes/no¹
- (b) Being not part of the lamp yes/no¹
- 9.6.6. Input voltage supplied by an electronic light source control gear:
- 9.6.7. Electronic light source control gear manufacturer and identification number
(when the light source control gear is part of the lamp but is not included into the
lamp body):
- 9.6.8. Geometrical conditions of installation and relating variations, if any:
10. Approval mark(s) position(s):
11. Reason(s) for extension of approval (if applicable):
12. Approval granted / extended / refused / withdrawn¹
13. Place:
14. Date:
15. Signature:
16. The list of documents deposited with the Type Approval Authority, which has
granted approval is annexed to this communication and may be obtained on
request.

¹² For cornering lamps with non-replaceable light sources indicate the number and total wattage of the light sources used.

Annex 2

Minimum requirements for conformity of production control procedures

1. General
 - 1.1 The conformity requirements shall be considered satisfied from a mechanical and geometric standpoint, if the differences do not exceed inevitable manufacturing deviations within the requirements of this Regulation. This condition also applies to colour.
 - 1.2. With respect to photometric performances, the conformity of mass-produced lamps shall not be contested if, when testing photometric performances of any lamp chosen at random and equipped with a standard (étalon) light source and/or non-replaceable light source(s) and/or LED module(s), as present in the lamp;
 - 1.2.1. No measured value deviates unfavourably by more than 20 per cent from the value prescribed in this Regulation.
 - 1.2.1.1. For class A, B and D headlamps corresponding to paragraphs 5.2. of this Regulation for the values B 50 L (or R) and zone III, the maximum unfavourable deviation may be respectively:

B 50 L (or R):	170 cd equivalent 20 per cent
	255 cd equivalent 30 per cent
Zone III:	255 cd equivalent 20 per cent
	380 cd equivalent 30 per cent
 - 1.2.1.2. For AFS corresponding to paragraph 5.3. of this Regulation no value measured and corrected according to the prescriptions of paragraph 4.6. of this Regulation, deviates unfavourably from the value prescribed in column B of the Tables 17 to 32, if applicable.
 - 1.2.1.3. For class BS, CS, DS and ES headlamps corresponding to paragraph 5.4. of this Regulation for values in zone I, the maximum unfavourable deviation may be respectively:

Zone I:	255 cd equivalent 20 per cent
	380 cd equivalent 30 per cent
 - 1.2.1.3.1. If the results of the test described above do not meet the requirements, the alignment of the headlamp may be changed, provided that the axis of the beam is not displaced laterally by more than 0.5 degree, to the right or left and not by more than 0.2 degree up and down.
 - 1.2.1.4. For front fog lamps corresponding to paragraph 5.5. of this Regulation Table 37 shall apply;
 - 1.2.2. or, in case of class A, B or D headlamps corresponding to paragraph 5.2. of this Regulation, if
 - 1.2.2.1. For the passing-beam, the values prescribed in this Regulation are met at one point within a circle of 0.35 degrees around points:

in case of class A or B headlamps B 50 L (or R) (with a tolerance of 85 cd), 75 R (or L), 50 V, 25 R, 25 L, and in the entire area of zone IV which is not more than 0.52 degrees above line 25 R and 25 L;

in case of class D headlamps B 50 L (or R) (with a tolerance of 85 cd), 75 R (or L), 50 V, 25 R1, 25 L2, and on segment I;

1.2.2.2. and if, for the driving beam, HV being situated within the isocandela $0.75 I_{\max}$ a tolerance of + 20 per cent for maximum values and -20 per cent for minimum values is observed for the photometric values at any measuring point specified in paragraph 5.1. of this Regulation.

1.2.2.3. If the results of the test described above do not meet the requirements, the alignment of the headlamp may be changed, provided that the axis of the beam is not displaced laterally by more than 0.5 degree to the right or left and not by more than 0.2 degree up and down.

1.2.3. For AFS corresponding to paragraph 5.3. of this Regulation, if the results of the test described above do not meet the requirements, the alignment of the system may be changed in each class, provided that the axis of the beam is not displaced laterally by more than 0.5 degree to the right or left and not by more than 0.2 degree up and down, each independently and with respect to the first aiming.

These provisions do not apply to lighting units as indicated under paragraph 5.3.3.1.1. of this Regulation.

1.2.4. If in the case of a lamp equipped with a replaceable light source the results of the tests described above do not meet the requirements, tests shall be repeated using another standard (étalon) light source.

1.3. With respect to the verification of the change in vertical position of the cut-off line under the influence of heat, the following procedure shall be applied:

One of the sampled lamps or systems shall be tested according to the procedure described in paragraph 3.1. of Annex 7 after being subjected three consecutive times to the cycle described in paragraph 3.2.2. of Annex 7

A headlamp or system shall be considered as acceptable if Δr does not exceed 1.5 mrad upwards and does not exceed 2.5 mrad downwards.

If this value exceeds 1.5 mrad but is not more than 2.0 mrad upwards or exceeds 2.5 mrad but is not more than 3.0 mrad downwards, a second sample shall be subjected to the test after which the mean of the absolute values recorded on both samples shall not exceed 1.5 mrad upwards and shall not exceed 2.5 mrad downwards.

However, if this value of 1.5 mrad upwards and 2.5 mrad downwards on these two systems is not complied with, another two systems shall be subjected to the same procedure and the value of Δr for each of them shall not exceed 1.5 mrad upwards and shall not exceed 2.5 mrad downwards.

A front fog lamp shall be considered as acceptable if Δr does not exceed 3.0 mrad. If this value exceeds 3.0 mrad but is not more than 4.0 mrad, a second front fog lamp shall be subjected to the test after which the mean of the absolute values recorded on both samples shall not exceed 3.0 mrad.

1.4. If, however, vertical adjustment cannot be performed repeatedly to the required position within the tolerances described in paragraph 1.2.3. of Annex 5 or paragraph 3.2. of Annex 6 respectively, one sample shall be

tested according to the procedure described in paragraph 2. of Annex 5 or paragraph 4. of Annex 6 respectively.

- 1.5. For cornering lamps
 - 1.5.1. With respect to photometric performances, the conformity of mass-produced lamps shall not be contested if, when testing photometric performances of any lamp chosen at random and equipped with a standard light source, or when the lamps are equipped with non-replaceable light sources (filament light sources or other), and when all measurements are made at 6.75 V, 13.5 V or 28.0 V respectively:
 - 1.5.1.1. No measured value deviates unfavourably by more than 20 per cent from the values prescribed in this Regulation.
 - 1.5.1.2. If, in the case of a lamp equipped with a replaceable light source and if results of the test described above do not meet the requirements, tests on lamps shall be repeated using another standard light source.
 - 1.5.2. The chromaticity coordinates shall be complied with when the lamp is equipped with a standard light source, or for lamps equipped with non-replaceable light sources (filament light sources or other), when the colorimetric characteristics are verified with the light source present in the lamp.
 - 1.5.3. In the case of non-replaceable filament light source(s) or light source module(s) equipped with non-replaceable filament light sources, at any conformity of production check:
 - 1.5.3.1. the holder of the approval mark shall demonstrate the use in normal production and show the identification of the non-replaceable filament light source(s) as indicated in the type approval documentation;
 - 1.5.3.2. in the case where doubt exists in respect to compliance of the non-replaceable filament light source(s) with lifetime requirements and/or, in the case of colour coated filament light sources, with colour endurance requirements, as specified in paragraph 4.11 of IEC 60809, Edition 3, conformity shall be checked as specified in paragraph 4.11 of IEC 60809, Edition 3.
- 1.6. The chromaticity coordinates shall be complied with.
2. Minimum requirements for verification of conformity by the manufacturer

For each type of lamp the holder of the approval mark shall carry out at least the following tests, at appropriate intervals. The tests shall be carried out in accordance with the provisions of this Regulation.

If any sampling shows non-conformity with regard to the type of test concerned, further samples shall be taken and tested. The manufacturer shall take steps to ensure the conformity of the production concerned.

 - 2.1. Nature of tests

Tests of conformity in this Regulation shall cover the photometric and colorimetric characteristics and the verification of the change in vertical position of the cut-off line under the influence of heat.
 - 2.2. Methods used in tests
 - 2.2.1. Tests shall generally be carried out in accordance with the methods set out in this Regulation.

- 2.2.2. In any test of conformity carried out by the manufacturer, equivalent methods may be used with the consent of the competent authority responsible for approval tests. The manufacturer is responsible for proving that the applied methods are equivalent to those laid down in this Regulation.
- 2.2.3. The application of paragraphs 2.2.1. and 2.2.2. requires regular calibration of test apparatus and its correlation with measurements made by a competent authority.
- 2.2.4. In all cases the reference methods shall be those of this Regulation, particularly for the purpose of administrative verification and sampling.
- 2.3. Nature of sampling
- Samples of lamps shall be selected at random from the production of a uniform batch. A uniform batch means a set of lamps of the same type, defined according to the production methods of the manufacturer.
- The assessment shall in general cover series production from individual factories. However, a manufacturer may group together records concerning the same type from several factories, provided these operate under the same quality system and quality management.
- 2.4. Measured and recorded photometric characteristics
- 2.4.1. The sampled devices shall be subjected to photometric measurements at the points provided for in the Regulation, the reading being limited:
- 2.4.1.1. For driving-beam headlamps according to paragraph 5.1. and / or passing-beam headlamps (asymmetrical) according to paragraph 5.2. of this Regulation apply:
- 2.4.1.1.1. For Classes A and B (driving and/or passing-beam headlamps of Classes A and B (asymmetrical)) to the points I_{\max} , HV¹, HL, HR² in the case of a driving-beam, and to points B 50 L (or R), HV, 50 V, 75 R (or L) and 25 L (or R) in the case of the passing-beam.
- 2.4.1.1.2. For Class D (driving and/or passing-beam headlamps of Class D (GDL asymmetrical)) to the points I_{\max} , HV¹, HL, HR² in the case of the driving beam, and to points B 50 L (or R)¹, HV, 50 V, 75 R (or L) and 25 L2 (or R2) in the case of the passing beam.
- 2.4.1.2. For driving-beam headlamps according to paragraph 5.1. and / or passing-beam headlamps (symmetrical) according to paragraph 5.4. of this Regulation apply:
- 2.4.1.2.1. For Class AS headlamps to the points HV, LH, RH, 12.5L and 12.5R.
- 2.4.1.2.2. For Class BS headlamps to the points I_{\max} and HV¹ in the case of the driving beam, and to the points HV, 0.86D/3.5R, 0.86D/3.5L in the case of the passing beam.
- 2.4.1.2.3. For Classes CS, DS and ES headlamps to the points I_{\max} and HV¹ in the case of the driving beam, and to the points HV, 0.86D/3.5R, 0.86D/3.5L in the case of the passing beam.

¹ When the driving-beam is reciprocally incorporated with the passing-beam, HV in the case of the driving-beam shall be the same measuring point as in the case of the passing-beam.

² HL and HR: points on HH located at 2.5 degrees to the left and to the right of point HV respectively.

- 2.4.1.3. For AFS according to paragraph 5.3. to this Regulation, to the points I_{\max} , HV¹, HL and HR³ in the case of a driving-beam and to points B50L, HV if applicable, 50V, 75R if applicable, and 25LL in the case of the passing-beam(s).
- 2.4.1.4. For front fog lamps according to paragraph 5.5. of this Regulation, to the points 8 and 9, and the lines 1, 5, 6, 8 and 9 as specified in Table 37.
- 2.4.2. For cornering lamps according to paragraph 5.6. of this Regulation, the samples shall be subjected to photometric measurements for the minimum values at the points indicated in Figure A4-XII in Annex 4 and the required chromaticity coordinates.
- 2.5. Criteria governing acceptability
- The manufacturer is responsible for carrying out a statistical study of the test results and for defining, in agreement with the competent authority, criteria governing the acceptability of his products in order to meet the requirements laid down for verification of conformity of products in paragraph 3.5.1. of this Regulation.
- The criteria governing the acceptability shall be such that with a confidence level of 95% the minimum probability of passing a spot check in accordance with Annex 3 (first sampling) would be 0.95.

³ HL and HR: points on HH located at 2.6 degrees to the left and to the right of point HV respectively.

Annex 3

Minimum requirements for sampling by an inspector

1. General
 - 1.1. The conformity requirements shall be considered satisfied from a mechanical and a geometric standpoint, in accordance with the requirements of this Regulation, if any, if the differences do not exceed inevitable manufacturing deviations.
 - 1.2. With respect to photometric performance, the conformity of mass-produced lamps shall not be contested if, when testing the photometric performances of any lamp chosen at random, and equipped with a standard (étalon) light source and/or non-replaceable light source(s) and/or LED module(s), as present in the lamp:
 - (a) No measured value deviates from the values prescribed in paragraph 1.2. of Annex 2;
 - (b) If, in the case of a lamp equipped with a replaceable light source and if results of the test described above do not meet the requirements, tests on lamps shall be repeated using another standard light source.
 - 1.3. Lamps with apparent defects are disregarded.
 - 1.4. The chromaticity coordinates shall be complied with.
2. First sampling

In the first sampling four lamps are selected at random. The first sample of two is marked A, the second sample of two is marked B.

 - 2.1. The conformity of mass-produced lamps shall not be contested if the deviation of any specimen of samples A and B (all four lamps) is not more than 20 per cent.

In the case, that the deviation of both lamps of sample A is not more than 0 per cent the measurement can be closed.
 - 2.2. The conformity of mass-produced lamps shall be contested if the deviation of at least one specimen of samples A or B is more than 20 per cent.

The manufacturer shall be requested to bring his production in line with the requirements (alignment) and a repeated sampling according to paragraph 3. shall be carried out within two months' time after the notification. The samples A and B shall be retained by the Technical Service until the entire COP process is finished.
3. First repeated sampling

A sample of four lamps is selected at random from stock manufactured after alignment.

The first sample of two is marked C, the second sample of two is marked D.

 - 3.1. The conformity of mass-produced lamps is shall not be contested if the deviation of any specimen of samples C and D (all four lamps) is not more than 20 per cent.

- In the case that the deviation of both lamps of sample C is not more than 0 per cent the measurement can be closed.
- 3.2. The conformity of mass-produced lamps shall be contested if the deviation of at least:
- 3.2.1. One specimen of samples C or D is more than 20 per cent but the deviation of all specimen of these samples is not more than 30 per cent.
- The manufacturer shall be requested again to bring his production in line with the requirements (alignment).
- A second repeated sampling according to paragraph 4. shall be carried out within two months' time after the notification. The samples C and D shall be retained by the Technical Service until the entire COP process is finished.
- 3.2.2. One specimen of samples C or D is more than 30 per cent.
- In this case the approval shall be withdrawn and paragraph 5. shall be applied.
4. Second repeated sampling
- A sample of four lamps is selected at random from stock manufactured after alignment.
- The first sample of two is marked E, the second sample of two is marked F.
- 4.1. The conformity of mass-produced lamps shall not be contested if the deviation of any specimen of samples E and F (all four lamps) is not more than 20 per cent.
- In the case that the deviation of both lamps of sample E is not more than 0 per cent the measurement can be closed.
- 4.2. The conformity of mass-produced lamps shall be contested if the deviation of at least one specimen of samples E or F is more than 20 per cent.
- In this case the approval shall be withdrawn and paragraph 5 shall be applied.
5. Approval withdrawn
- Approval shall be withdrawn according to paragraph 3.6. of this Regulation.
6. Change of the vertical position of the cut-off line for passing beam
- With respect to the verification of the change in vertical position of the cut-off line for passing beam under the influence of heat, the following procedure shall be applied:
- One of the lamps or system of sample A shall be tested according to the procedure described in paragraph 3. of Annex 7 after being subjected three consecutive times to the cycle described in paragraph 3.2.2. of Annex 7.
- The passing beam or the system shall be considered as acceptable if Δr does not exceed 1.5 mrad upwards and does not exceed 2.5 mrad downwards.
- If this value exceeds 1.5 mrad but is not more than 2.0 mrad upwards or exceeds 2.5 mrad but is not more than 3.0 mrad downwards, a second system of sample A shall be subjected to the test after which the mean of the absolute values recorded on both samples shall not exceed 1.5 m rad upwards and shall not exceed 2.5 mrad downwards.

However, if this value of 1.5 mrad upwards and 2.5 mrad downwards on sample A is not complied with, another two systems of sample B shall be subjected to the same procedure and the value of Δr for each of them shall not exceed 1.5 mrad upwards and shall not exceed 2.5 mrad downwards.

In the case of front fog lamps in accordance with paragraph 5.5. to this Regulation the lamp shall be considered as acceptable if r does not exceed 3.0 mrad.

If this value exceeds 3.0 mrad but is not more than 4.0 mrad, the second front fog lamp of sample A shall be subjected to the test after which the mean of the absolute values recorded in both samples shall not exceed 3.0 mrad.

However, if this value of 3.0 mrad on sample A is not complied with, the two front fog lamps of sample B shall be subjected to the same procedure and the value of r for each of them shall not exceed 3.0 mrad.

Annex 4

Spherical coordinate measuring system and test point locations

Figure A4-I
Spherical coordinate measuring system

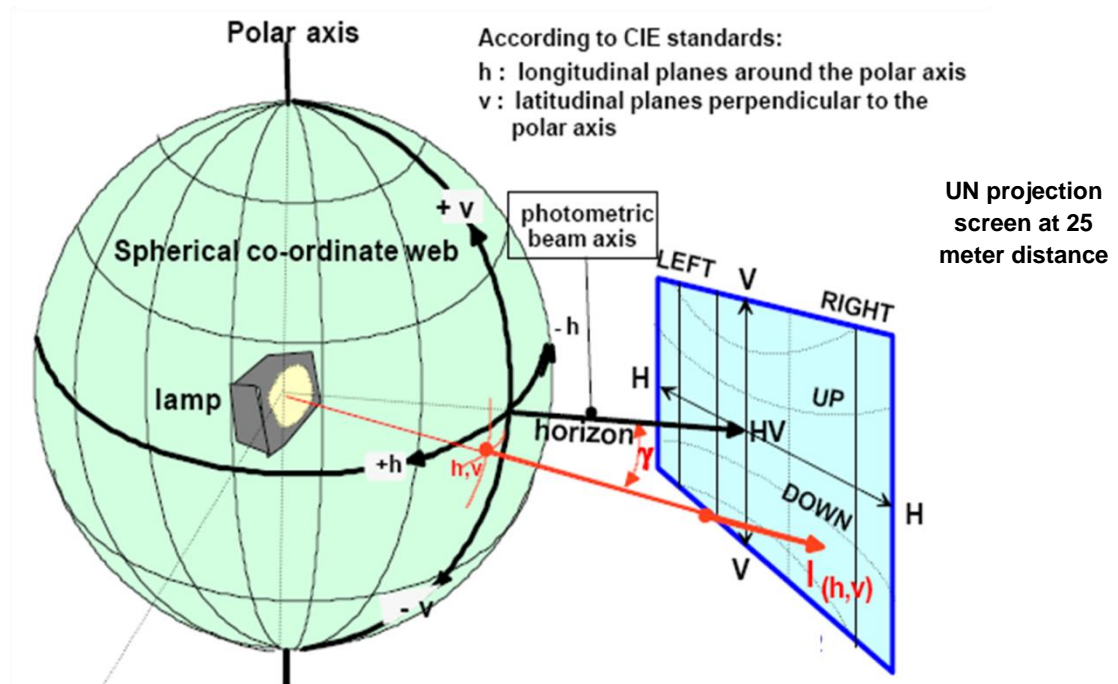

$$E_{25m} = I_{(h,v)} \times \cos \gamma / r^2$$

1. Photometric measurement provisions
 - 1.1. The RID or part(s) thereof shall be mounted on a goniometer with a fixed horizontal axis and moveable axis perpendicular to the fixed horizontal axis.
 - 1.1.1. The luminous intensity values shall be determined by means of a photoreceptor contained within a square of 65 mm side and, except for cornering lamps, set up to a distance of at least 25 m forward of the centre of reference of each headlamp or lighting unit perpendicular to the measurement axis from the origin of the goniometer. The point HV is the centre-point of the coordinate system with a vertical polar axis. Line h is the horizontal through HV (see Figure A4-1).
 - 1.1.2. The angular co-ordinates are specified in deg on a sphere with a vertical polar axis according to the gonio-photometer as defined in Figure A4-1.
 - 1.1.3. During photometric measurements, stray reflections should be avoided by appropriate masking.
 - 1.2. Any equivalent photometric method is acceptable, if the accordingly applicable correlation is observed.

- 1.3. An aiming screen shall be used and may be located at a shorter distance than that of the photoreceptor.
- 1.4. The RID or part(s) thereof shall be so aimed before starting the measurements that the position of the "cut-off" complies with the relevant requirements for the specific function in paragraph 5 to this Regulation.
- 1.5. In case of AFS:
 - 1.5.1. Any offset of the centre of reference of each lighting unit, with respect to the goniometer rotation axes, should be avoided. This applies especially to the vertical direction and to lighting units producing a "cut-off".
 - 1.5.2. The photometric requirements for each single measuring point (angular position) of a lighting function or mode as specified in this Regulation apply to half of the sum of the respective measured values from all lighting units of the system applied for this function or mode, or, from all lighting units as indicated in the respective requirement;
 - 1.5.2.1. However in those cases where a provision is specified for one side only, the division by the factor of 2 does not apply. These cases are: paragraphs 5.3.2.5.2., 5.3.2.8.1., 5.1.3.5., 5.1.3.6., 5.3.3.4.1., 5.3.5.1. of this Regulation, and note 4 of Table 9.
 - 1.5.3. The lighting units of the system shall be measured individually; however, simultaneous measurements may be performed on two or more lighting units of an installation unit, being equipped with the same light source types with respect to their power supply (either power controlled or not), if they are sized and situated such, that their illuminating surfaces are completely contained in a rectangle of not more than 300 mm in horizontal extend and not more than 150 mm vertical extend, and, if a common centre of reference is specified by the manufacturer.
 - 1.5.4. The system shall prior to the subsequent test procedures be set to the neutral state.
 - 1.5.5. The system or part(s) thereof shall be so aimed before starting the measurements that the position of the "cut-off" complies with the requirements indicated in the Table 10. Parts of a system measured individually and having no "cut-off" shall be installed on the goniometer under the conditions (mounting position) specified by the applicant.
- 1.6. In case of Cornering lamps
 - 1.6.1. When photometric measurements are taken, stray reflections shall be avoided by appropriate masking.
 - 1.6.2. In the event that the results of measurements are challenged, measurements shall be taken in such a way as to meet the following requirements:
 - 1.6.2.1. The distance of measurement shall be such that the law of the inverse of the square of the distance is applicable;
 - 1.6.2.2. The measuring equipment shall be such that the angle subtended by the receiver from the reference centre of the light is between 10' and 1°;
 - 1.6.2.3. The intensity requirement for a particular direction of observation shall be satisfied if the required intensity is obtained in a direction deviating by not more than one quarter of a degree from the direction of observation.

2. Test point locations:

Figure A4-II

Driving beam test points

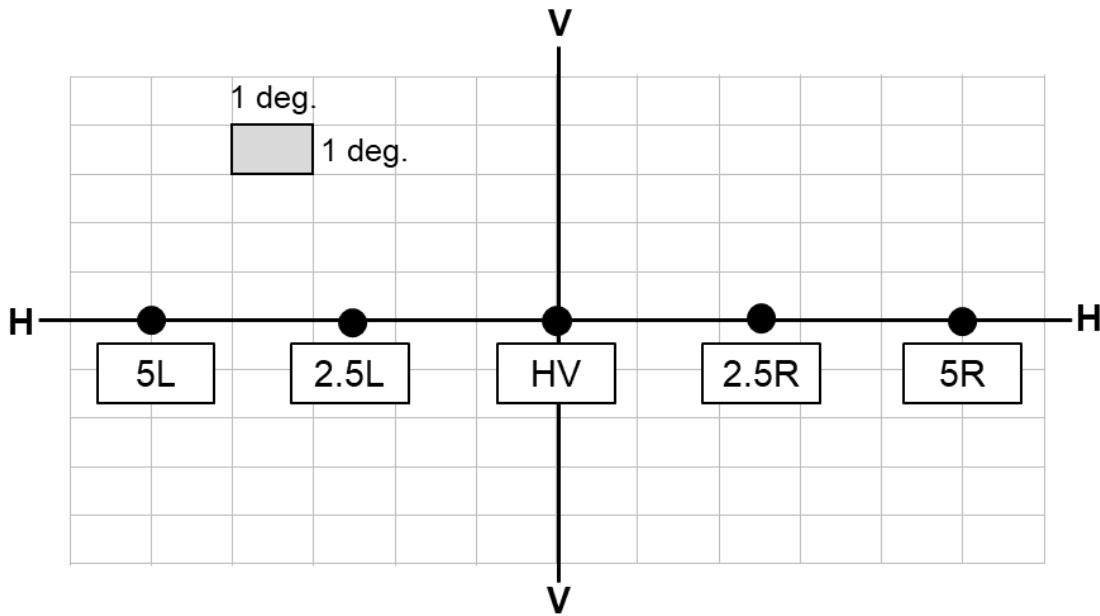

h-h = horizontal plane, v-v = vertical plane passing through the optical axis of the headlamp

Figure A4-III

Primary driving beam - position of test points

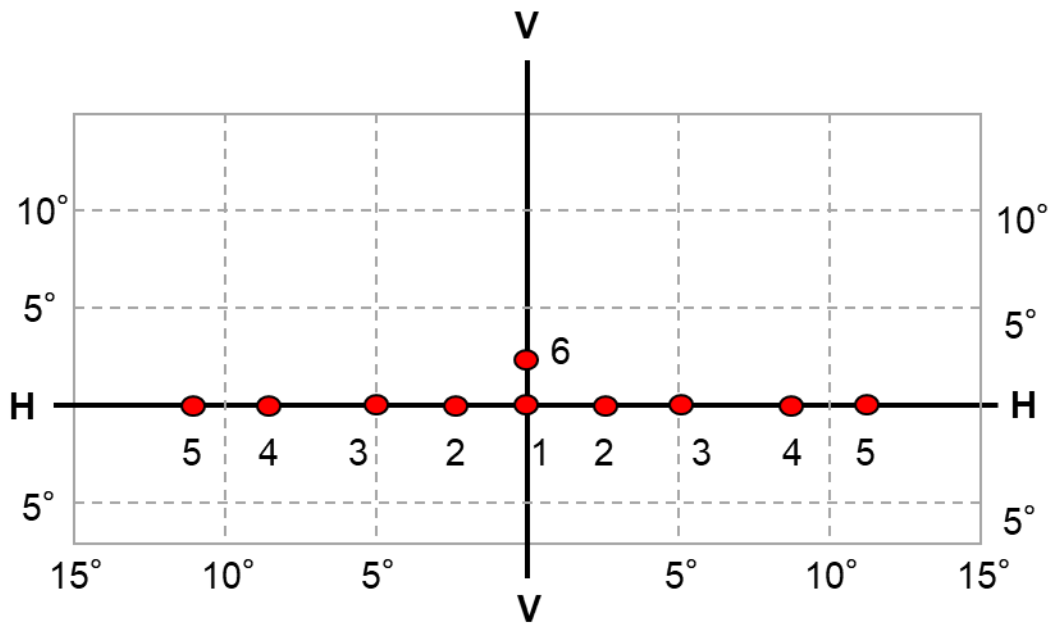

Figure A4-IV
Secondary driving beam - position of test points

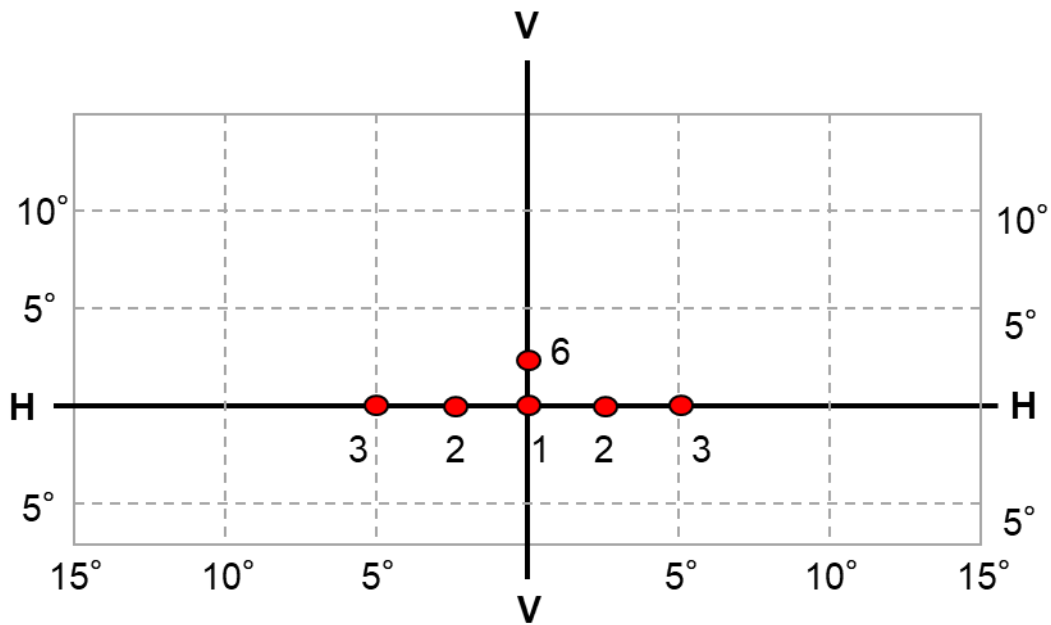
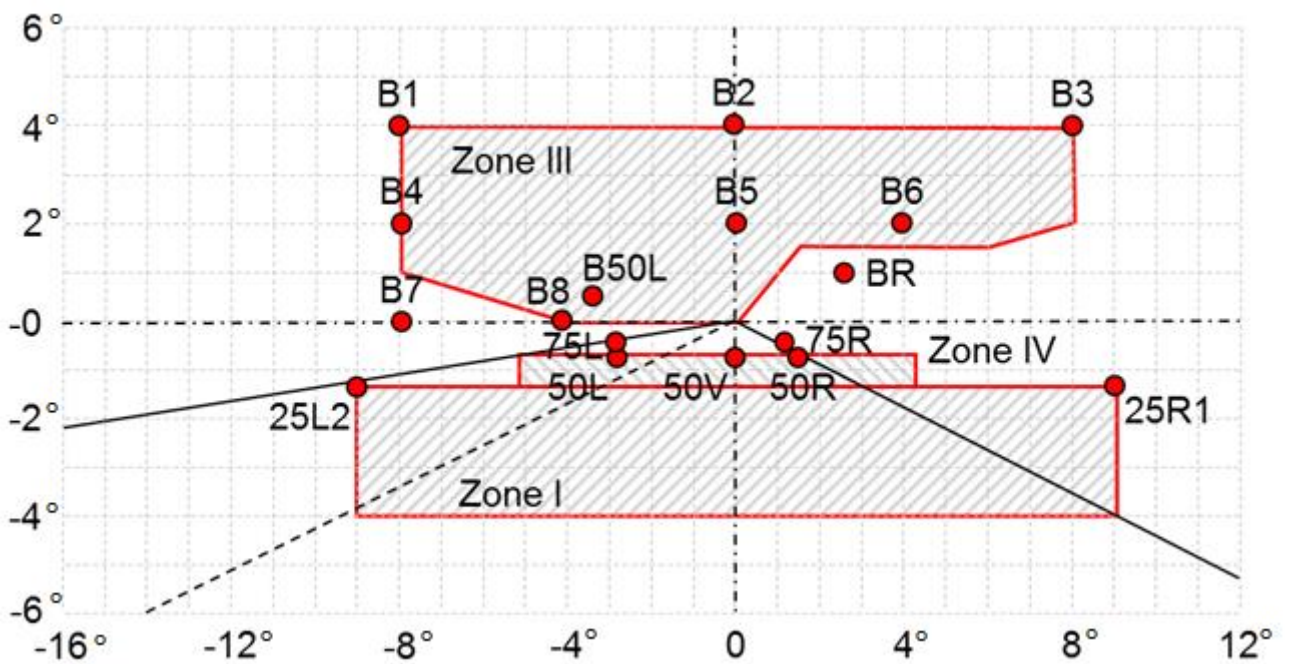
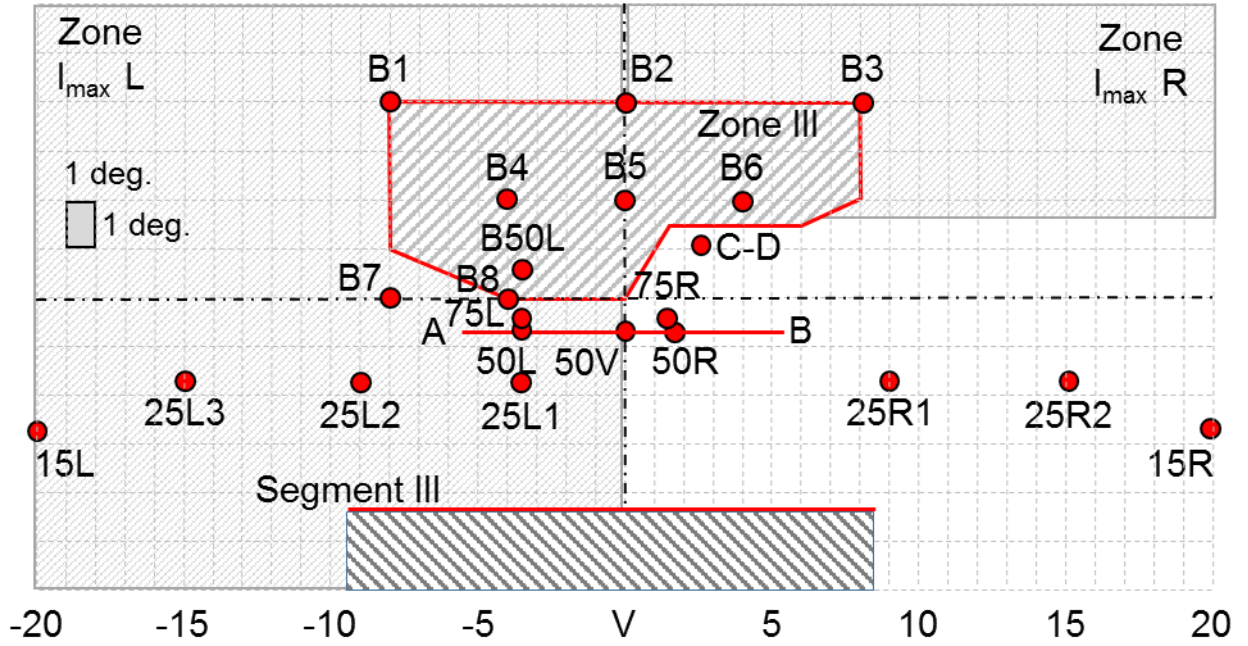

Figure A4-V
Passing-beam for right-hand traffic



The test point locations for left-hand traffic are mirrored about the VV line

Figure A4-VI
 Passing beam with gas discharge light sources for right-hand traffic



h-h = horizontal plane, v-v = vertical plane passing through the optical axis of the headlamp

The test point locations for left-hand traffic are mirrored about the V-V line

Figure A4-VII
AFS Passing-beam for right-hand traffic*

* *Note:* The measurement procedure is prescribed in Annex 4

For the purpose of this Annex:

"above it" means vertically above, only;

"below it" means vertically below, only.

Angular positions of passing-beam photometric requirements are indicated for right-hand traffic and are expressed in deg up (U) or down (D) from H-H respectively right (R) or left (L) from V-V.

The test point locations for left-hand traffic are mirrored about the V-V line

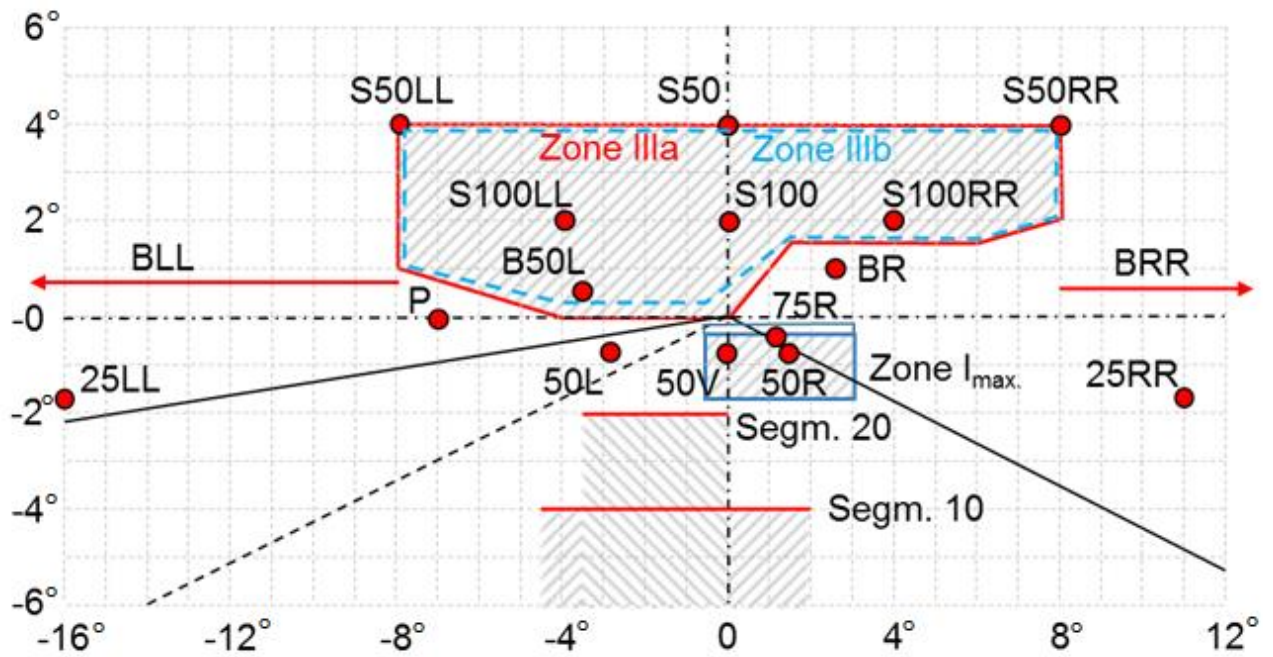

Figure A4-VIII
 Passing beam test points and zones for Class AS headlamp(s)

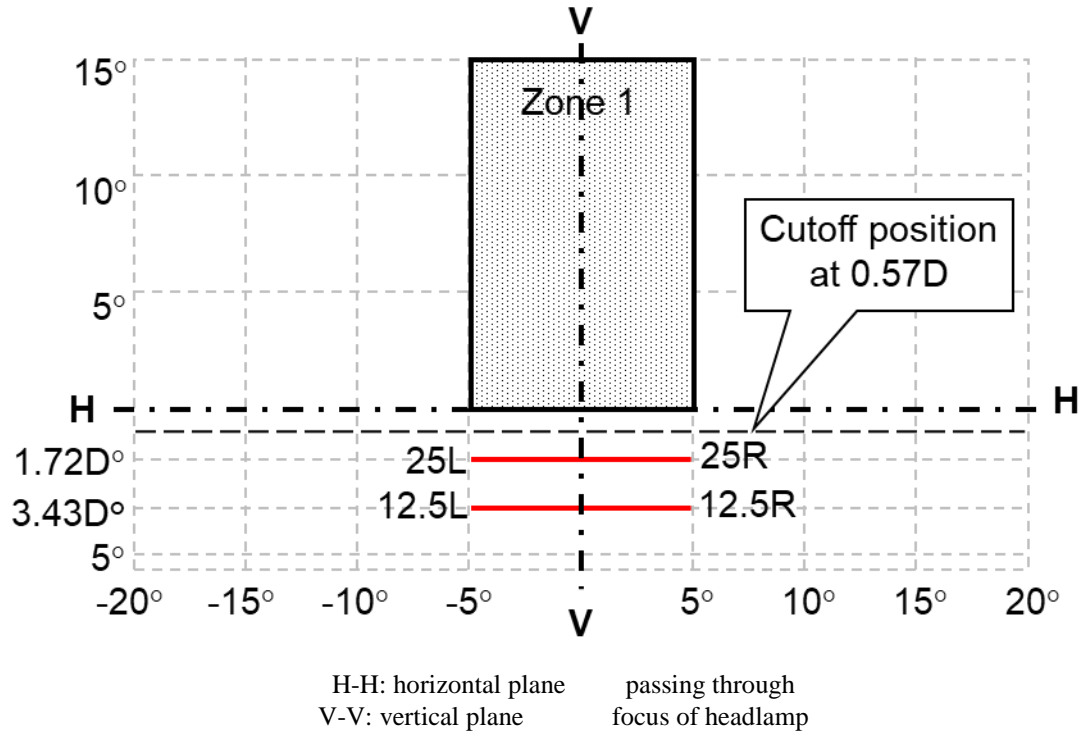
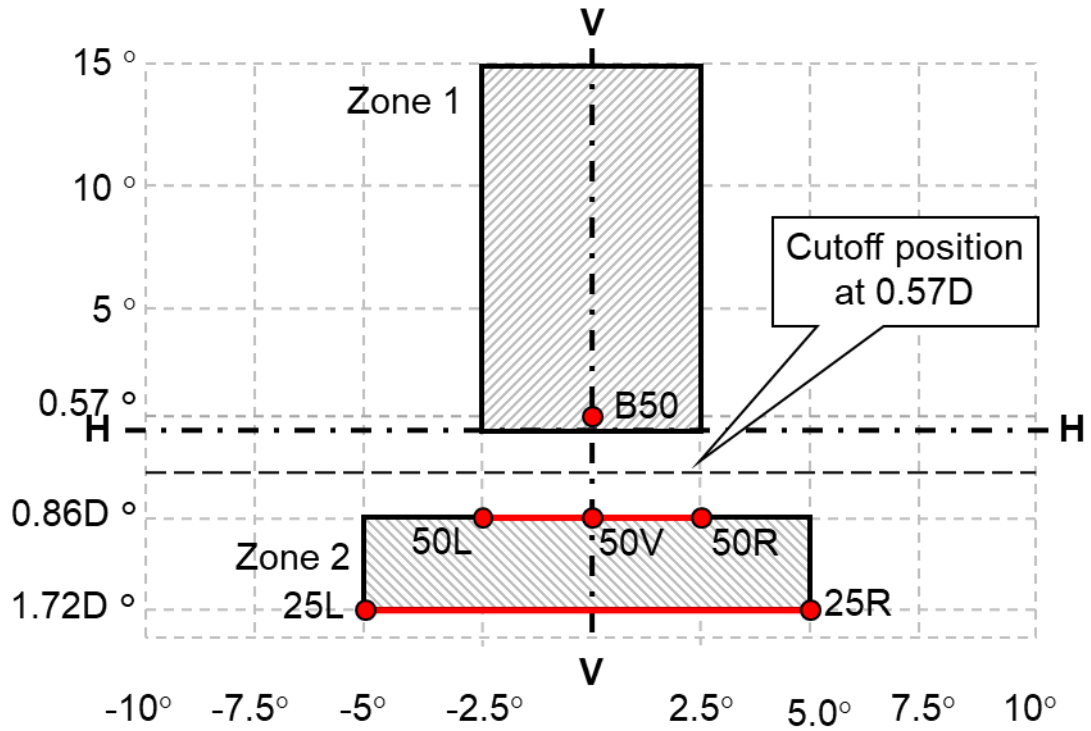

Figure A4-IX
 Passing beam test points and zones for Class BS headlamp(s)



H-H: horizontal plane passing through
 V-V: vertical plane focus of headlamp

Figure A4-X
 Passing beam - position of test points and zones for Classes CS, DS and ES headlamp(s)

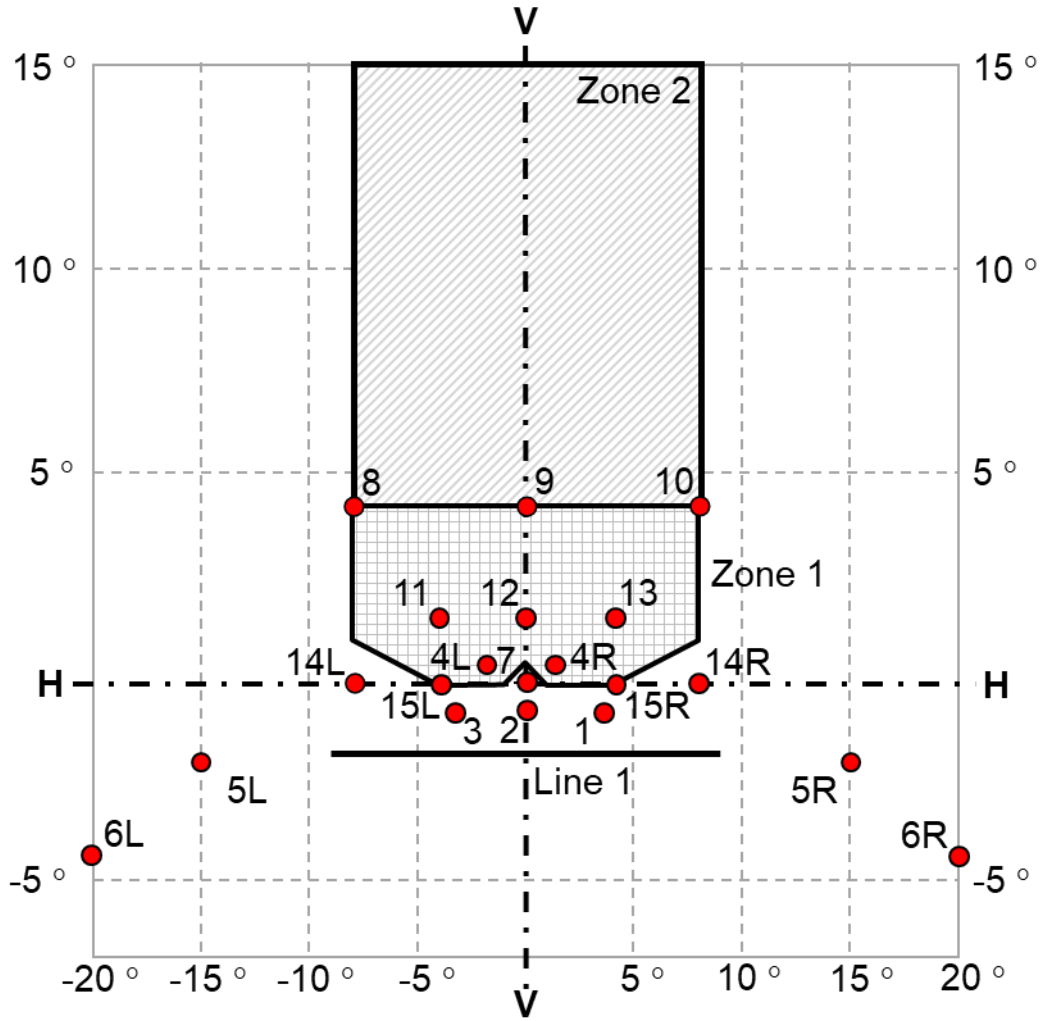

Figure A4-XI
 Light distribution of the Class F3 front fog lamp

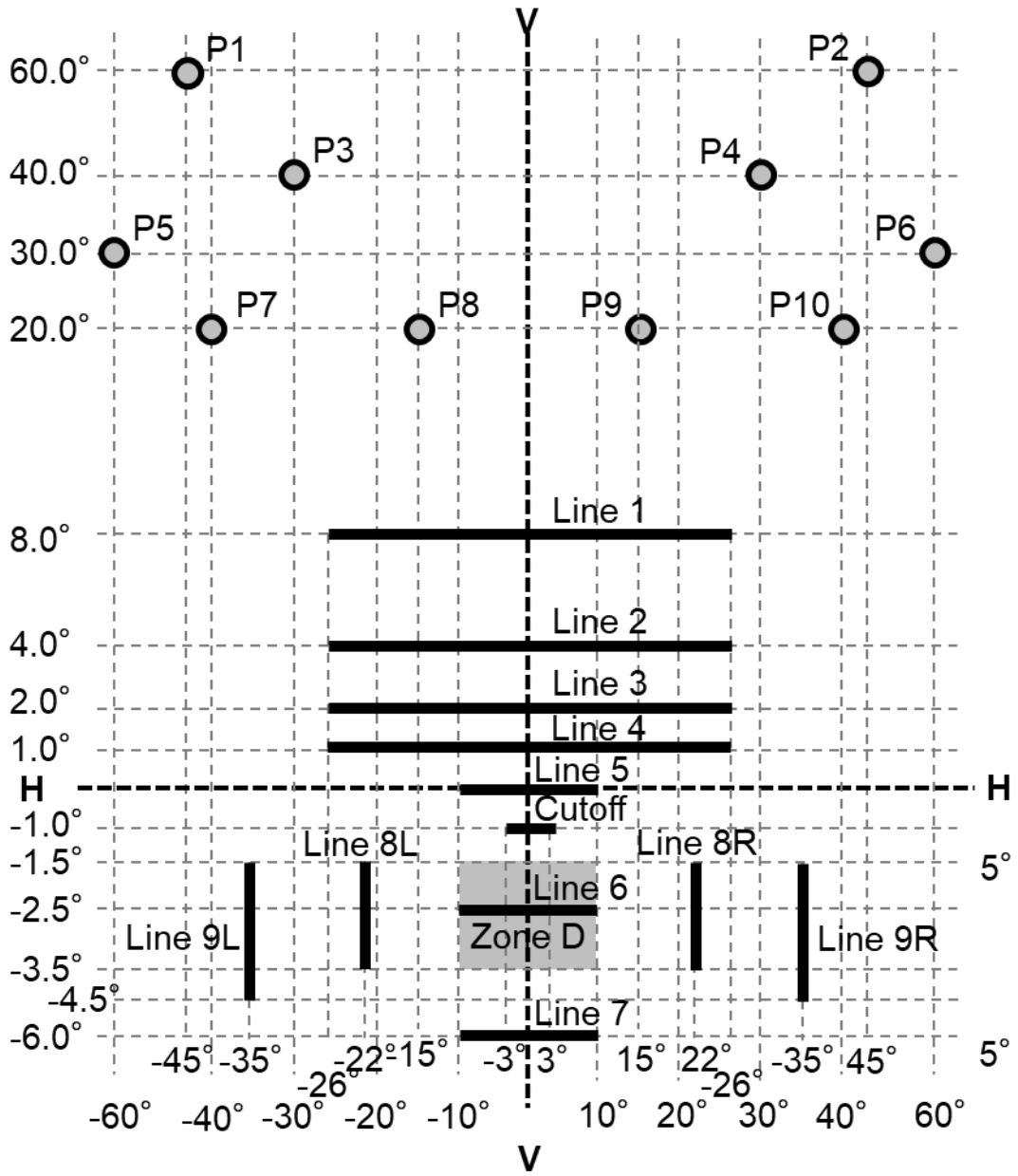

Figure A4-XII
 Measuring points for cornering lamps (left side lamp)

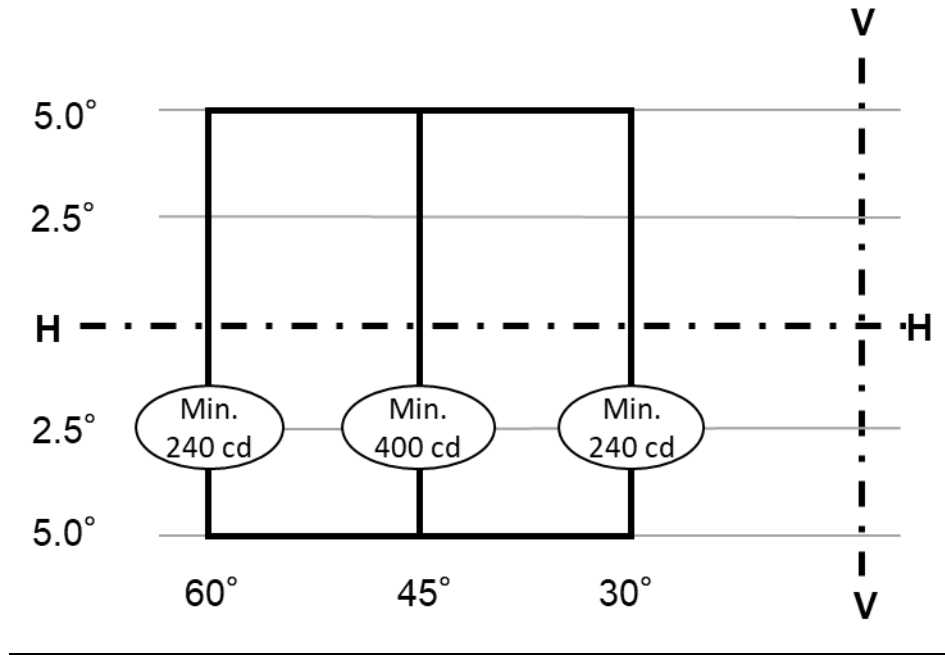
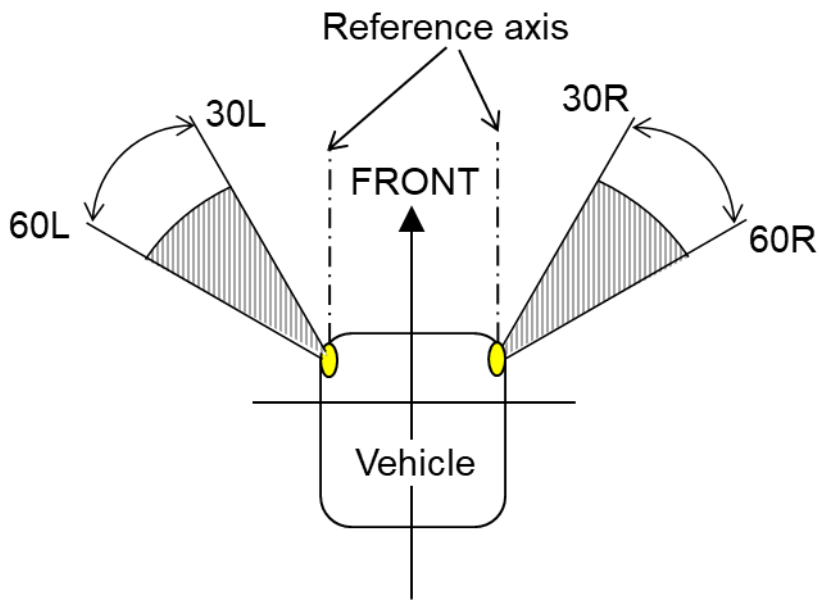
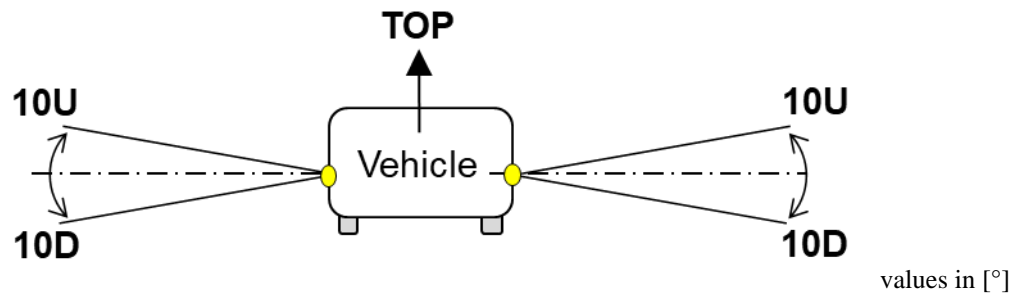

Figure A4-XIII
 Horizontal geometric visibility for cornering lamps



values in [°]

Figure A4-XIV
Vertical geometric visibility for cornering lamps



Annex 5

Aiming procedure, instrumental verification of the "cut-off" for asymmetric passing-beams

1. Visual aiming procedure
 - 1.1. The luminous intensity distribution of a principal passing-beam headlamp or of at least one lighting unit for a class C passing beam of an AFS in its neutral state shall incorporate a "cut-off" (see Figure A5-I), which enables the headlamp to be adjusted correctly for the photometric measurements and for the aiming on the vehicle.

The "cut-off" shall provide:

 - (a) For right hand traffic beams:
 - (i) A straight "horizontal part" towards the left;
 - (ii) A raised "elbow - shoulder" part towards the right.
 - (b) For left hand traffic beams:
 - (i) A straight "horizontal part" towards the right;
 - (ii) A raised "elbow - shoulder" part towards the left.

In each case the "elbow-shoulder" part shall have a sharp edge.
 - 1.2. The headlamp or AFS shall be visually aimed by means of the "cut-off" (see Figure A5-I) as follows. The aiming shall be carried out using a flat vertical screen set up at a distance of 10 m or 25 m (as indicated in item 9 of Annex 1) forward of the headlamp or AFS and at right angles to the H-V axis as shown in Annex 4. The screen shall be sufficiently wide to allow examination and adjustment of the "cut-off" of the passing-beam over at least 5° on either side of the V-V line.
 - 1.2.1. For vertical adjustment: the horizontal part of the "cut-off" is moved upward from below line B and adjusted to its nominal position one per cent (0.57 degrees) below the H-H line;

Figure A5-I
Visual aiming of the cut-off

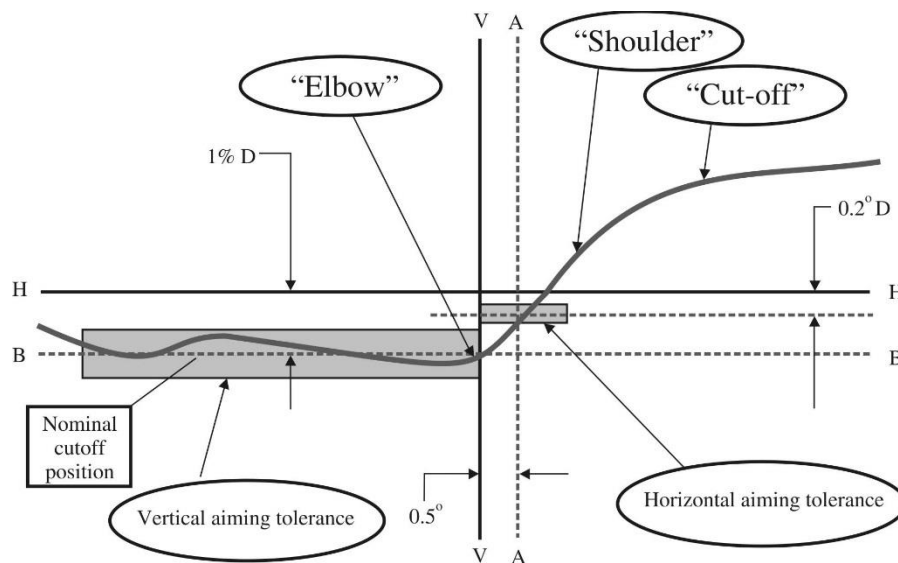

Note: The scales are different for vertical and horizontal lines.

1.2.2. For horizontal adjustment: the "elbow – shoulder" part of the "cut-off" shall be moved:

For right hand traffic from right to left and shall be horizontally positioned after its movement so that:

- (a) Above the line $0.2^\circ D$ its "shoulder" shall not exceed the line A to the left;
- (b) The line $0.2^\circ D$ or below its "shoulder" should cross the line A; and
- (c) The kink of the "elbow" is basically located within ± 0.5 degrees to the left or right of the V-V line;

or

For left hand traffic from left to right and shall be horizontally positioned after its movement so that:

- (a) Above the line $0.2^\circ D$ its "shoulder" shall not exceed the line A to the right;
- (b) On the line 0.2° or below its "shoulder" cross the line A; and
- (c) The kink of the "elbow" should be primarily on the V-V line;

1.2.3. Where a headlamp or AFS so aimed does not meet the requirements set out in paragraphs this Regulation 5.2. to 5.4. of this Regulation respectively, its alignment may be changed, provided that the axis of the beam is not displaced:

Horizontally from line A by more than:

- (a) 0.5° to the left or 0.75° to the right, for right hand traffic; or

(b) 0.5° to the right or 0.75° to the left, for left hand traffic; and

Vertically not more than 0.25° up or down from line B.

1.2.4. If, however, vertical adjustment cannot be performed repeatedly to the required position within the tolerances described in paragraph 1.2.3., the instrumental method of paragraph 2. shall be applied to test compliance with the required minimum quality of the "cut-off" and to perform the vertical and horizontal adjustment of the beam.

1.2.5. When so aimed, a headlamp, if its approval is sought solely for provision of a passing-beam⁹, need comply only with the requirements set out in paragraphs 5.2. to 5.4. of this Regulation; if it is intended to provide both a passing-beam and a driving-beam, it shall comply with the requirements set out in paragraphs 5.1. to 5.4. of this Regulation.

2. Instrumental verification of the "cut-off" line for asymmetric passing-beams

2.1. General

In the case where paragraph 1.2.4. applies, the quality of the "cut-off" line shall be tested according to the requirements set out in paragraph 2.2. and the instrumental vertical and horizontal adjustment of the beam shall be performed according to the requirements set out in paragraph 2.3.

Before carrying out the measurement of the quality of "cut-off", and the instrumental aiming procedure, a visual pre-aim in accordance with paragraphs 1.2.1. and 1.2.2. is required.

2.2. Measurement of the quality of the "cut-off"

To determine the minimum sharpness, measurements shall be performed by vertically scanning through the horizontal part of the "cut-off" in angular steps of 0.05° at either a measurement distance of:

- (a) 10 m with a detector having a diameter of approximately 10 mm; or
- (b) 25 m with a detector having a diameter of approximately 30 mm.

The measuring distance at which the test was carried out shall be recorded in item 9. of the communication form (see Annex 1 to this Regulation).

To determine the maximum sharpness, measurements shall be performed by vertically scanning through the horizontal part of the "cut-off" in angular steps of 0.05° exclusively at a measurement distance of 25 m and with a detector having a diameter of approximately 30 mm.

The "cut-off" quality shall be considered acceptable if the requirements of paragraphs 2.2.1. to 2.2.3. comply with at least one set of measurements.

2.2.1. Not more than one "cut-off" shall be visible¹

2.2.2. Sharpness of "cut-off"

The sharpness factor G is determined by scanning vertically through the horizontal part of the "cut-off" at 2.5° from the V-V where:

$G = (\log E_\beta - \log E_{(\beta + 0.1^\circ)})$ where β = the vertical position in degrees and E = the illumination on the aiming screen.

¹ This paragraph should be amended when an objective test method is available.

The value of G shall not be less than 0.13 (minimum sharpness) and not greater than 0.40 (maximum sharpness).

2.2.3. Linearity

The part of the horizontal "cut-off" that serves for vertical adjustment shall be horizontal between 1.5° and 3.5° from the V-V line (see Figure A5-II).

The inflection points of the "cut-off" gradient at the vertical lines at 1.5° , 2.5° and 3.5° shall be determined by the equation:

The maximum vertical distance between the inflection points determined shall not exceed 0.2° .

$$(d^2 (\log E) / d\beta^2 = 0).$$

2.3. Vertical and horizontal adjustment

If the "cut-off" complies with the quality requirements of paragraph 2.2. the beam adjustment may be performed instrumentally.

Figure A5-II
Measurement of "cut-off" quality

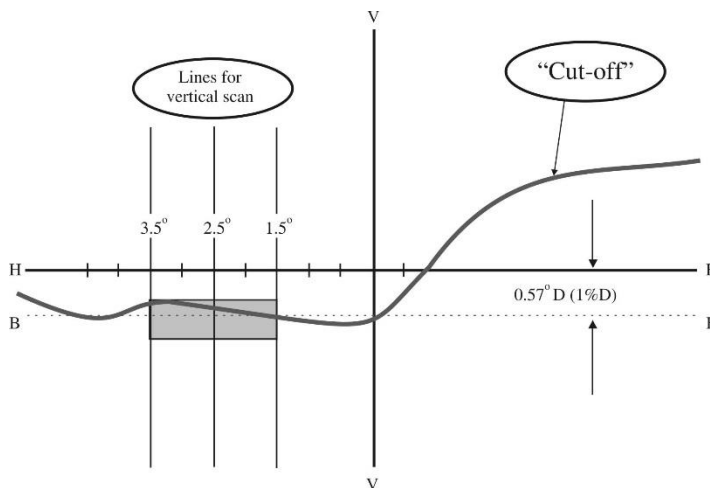

Note: The scales are different for vertical and horizontal lines.

2.3.1. Vertical adjustment

Moving upward from below the line B (see Figure A5-III), a vertical scan is carried out through the horizontal part of the "cut-off" at 2.5° from V-V. The inflection point (where $d^2 (\log E) / d\beta^2 = 0$) is determined and positioned on the line B situated one per cent below H-H.

2.3.2. Horizontal adjustment

The applicant shall specify one of the following horizontal aim methods:

- (a) The "0.2 D line" method (see Figure A5-III).

A single horizontal line at $0.2^\circ D$ shall be scanned from 5° left to 5° right after the lamp has been aimed vertically. The maximum gradient " G " determined using the formula $G = (\log E_\beta - \log E_{(\beta + 0.1^\circ)})$ where β is the horizontal position in degrees, shall not be less than 0.08.

The inflection point found on the $0.2^\circ D$ line shall be positioned on the line A.

Figure A5-III
Instrumental vertical and horizontal adjustment - horizontal line scan method

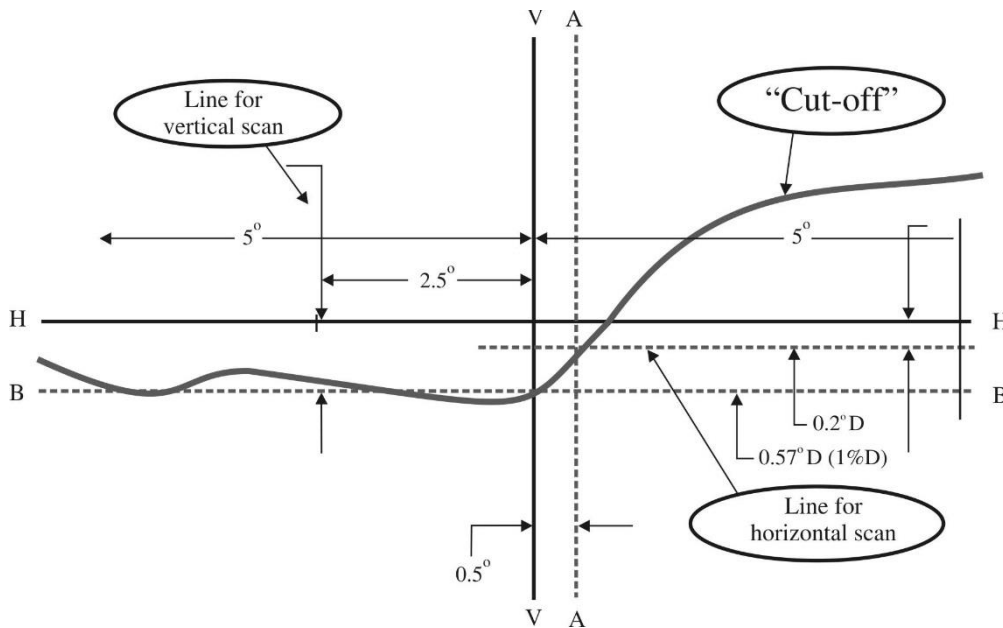

Note: The scales are different for vertical and horizontal lines.

(b) The "3 line" method (see Figure A5-IV)

Three vertical lines shall be scanned from 2° D to 2° U at 1°R, 2°R, and 3°R after the lamp has been aimed vertically. The respective maximum gradients "G" determined using the formula:

$$G = (\log E_{\beta} - \log E_{(\beta + 0.1^{\circ})})$$

where β is the vertical position in degrees, shall not be less than 0.08. The inflection points found on the three lines shall be used to derive a straight line. The intersection of this line and the line B found while performing vertical aim shall be placed on the V line.

Figure A5-IV
Instrumental vertical and horizontal adjustment - Three line scan method

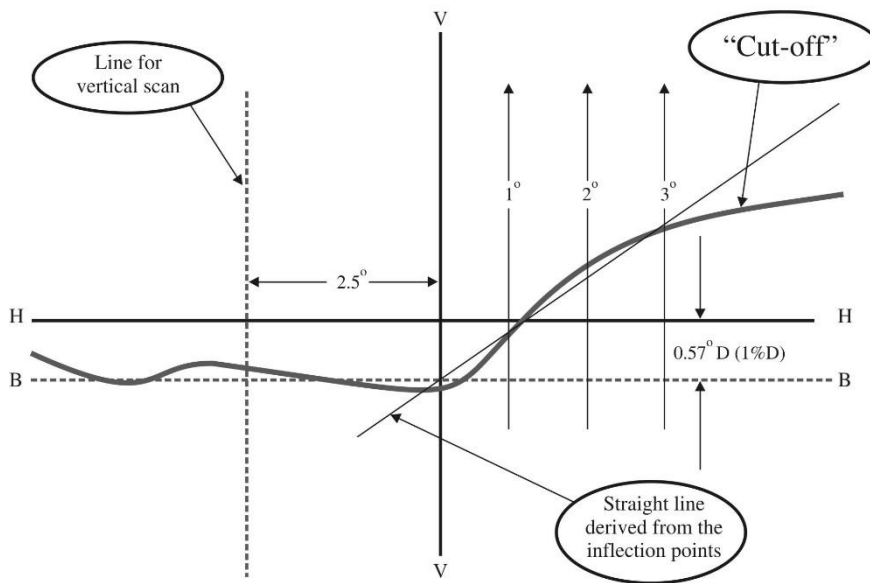

Note: The scales are different for vertical and horizontal lines.

Annex 6

Definition and sharpness of the horizontal "cut-off" line and aiming procedure by means of this "cut-off" line for symmetrical passing beam headlamps and front fog lamps

1. General
 - 1.1. The luminous intensity distribution of the symmetrical passing-beam headlamps and front fog lamp shall incorporate a "cut-off" line which enables the lamp to be adjusted correctly for the photometric measurements and for the aiming on the vehicle. The characteristics of the "cut-off" line shall comply with the requirements set out in paragraphs 2. to 4.:
2. Shape of the "cut-off" line
 - 2.1. For visual adjustment of the lamp the "cut-off" line shall provide:
 - 2.1.1. A horizontal line for vertical adjustment of the symmetrical passing-beam headlamp extending to either side of the V-V line (see Figure A6-I) as specified in paragraph 5.4.1.1. of this Regulation.
 - 2.1.2. A horizontal line for vertical adjustment of the front fog lamp extending to 4° either side of the V-V line (see Figure A6-II).

Figure A6-I

Shape and position of the "cut-off" line of symmetrical passing-beam headlamp

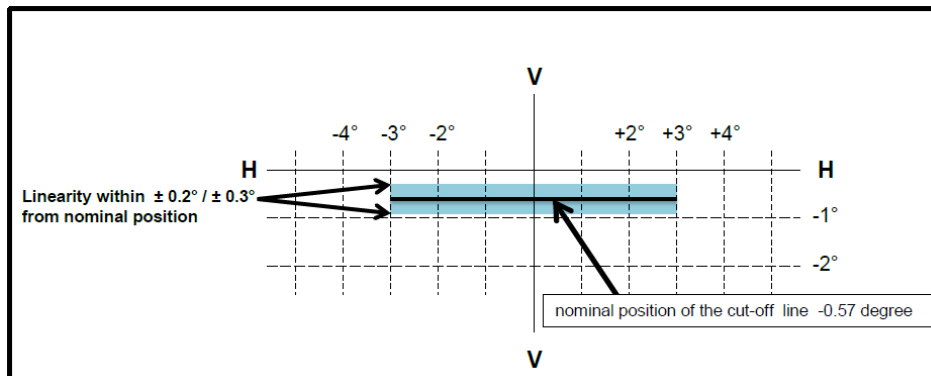
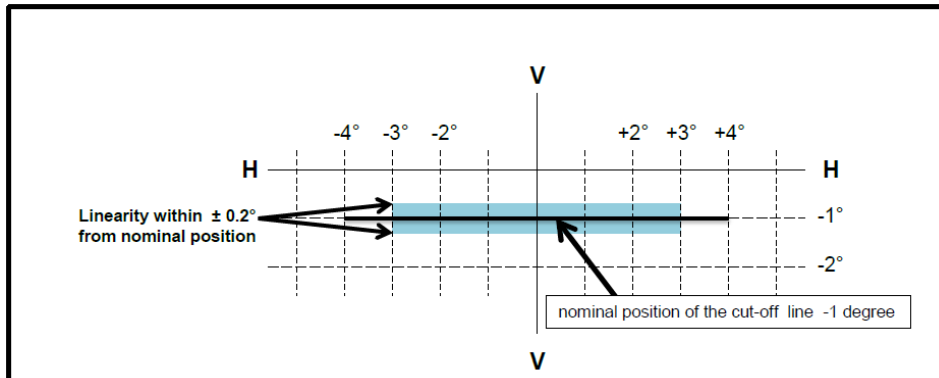

Figure A6-II
Shape and position of the “cut-off” line of the front fog lamp



3. Adjustment of the symmetrical passing-beam headlamp and front fog lamp.
 - 3.1. Horizontal adjustment: the cut-off line shall be so positioned that the projected beam pattern appears approximately symmetrical to the V-V line. When the front fog lamp is designed for use in pairs or has otherwise an asymmetric beam pattern, it shall be horizontally aligned according to the specification of the applicant, or otherwise in such a way that the cut-off line appears symmetrical to the V-V line.
 - 3.2. Vertical adjustment: after horizontal adjustment of the lamp according to paragraph 3.1., the vertical adjustment shall be performed in such a way that the beam with its "cut-off" line is moved upwards from the lower position until the "cut-off" line is situated at nominal vertical position. For nominal vertical adjustment the "cut-off" line is positioned on the V-V line
 - (a) At 0.57 degree (1 per cent) below the h-h line for symmetrical headlamps of the Classes AS, BS, CS, DS and ES;
 - (b) At 1 degree below the h-h line for front fog lamps.

If the horizontal part is not straight but slightly curved or inclined, the "cut-off" line shall not exceed the vertical range formed by two horizontal lines which are situated from 3° left to 3° right of the V-V line at:

 - (a) 0.2° for Class BS headlamps and front fog lamps;
 - (b) 0.3° for Classes AS, CS, DS and ES headlamps;

above and below the nominal position of the "cut-off" (see Figures A6-I and A6-II respectively).
 - 3.3. If the vertical positions of three attempts to adjust the cut-off differ by more than:
 - (a) 0.2° for Class BS headlamps and front fog lamps;
 - (b) 0.3° for Classes AS, CS, DS and ES headlamps;

the horizontal part of the "cut-off" line is assumed not to provide sufficient linearity or sharpness for performing visual adjustment. In this case the quality of "cut-off" shall be tested instrumentally for compliance with requirements as follows.

4. Measurement of the quality of "cut-off"
- 4.1. Measurements shall be performed by vertically scanning through the horizontal part of the "cut-off" line in angular steps not exceeding 0.05°:
- (a) At either a measurement distance of 10 m and a detector with a diameter of approximately 10 mm;
 - (b) Or at a measurement distance of 25 m and a detector with a diameter of approximately 30 mm.

The measurement of the "cut-off" quality shall be considered acceptable if the requirements of the paragraph 4.1.1. to 4.1.3. comply with at least one measurement at 10 m or 25 m.

The measuring distance at which the test was determined shall be noted down in the communication form according to Annex 1, paragraph 9.2.6.

The scanning is performed from its lower position upwards through the "cut-off" line along the vertical lines at:

- (a) - 3° to -1.5° and +1.5° to +3° from the V-V line for headlamps
- (b) - 2.5° and + 2.5° from the V-V line for front fog lamps.

When so measured, the quality of the "cut-off" line shall meet the following requirements:

- 4.1.1. Not more than one "cut-off" line shall be visible¹.
- 4.1.2. Sharpness of "cut-off": if scanned vertically through the horizontal part of the "cut-off" line along the $\pm 2.5^\circ$ -lines, the maximum value measured for:

$$G = (\log E_\beta - \log E_{(\beta+0.1^\circ)})$$

is called the sharpness factor G of the "cut-off" line. The value of G shall not be less than:

- (a) 0.13 for Class BS headlamps;
 - (b) 0.08 for Classes AS, CS, DS, ES headlamps and front fog lamps.
- 4.1.3. Linearity: the part of the "cut-off" line which serves for vertical adjustment shall be horizontal from 3°L to 3°R of the V-V line. This requirement is deemed to be met if the vertical positions of the inflection points according to paragraph 3.2. above at 3° left and right of the V-V line do not differ by more than:
- (a) 0.2° for Class BS headlamps and front fog lamps;
 - (b) 0.3° for Classes AS, CS, DS and ES headlamps;

from the nominal position at the V-V line.

5. Instrumental vertical adjustment

If the "cut-off" line complies with the above quality requirements, the vertical beam adjustment can be performed instrumentally. For this purpose the inflection point where $d^2(\log E) / dv^2 = 0$ is positioned on the V-V line in its nominal position below the h-h-line. The movement for measuring and adjusting the "cut-off" line shall be upwards from below the nominal position.

¹ This paragraph should be amended when an objective test method is available.

Annex 7

Tests for stability of photometric performance of Road Illumination Devices in operation (except cornering lamps)

1. Tests on complete Road Illumination Devices (RID)

Once the photometric values have been measured according to this Regulation:

- (a) In the case of a headlamp with an asymmetrical passing-beam pattern:
at the point for I_{\max} for driving-beam and in points 25L, 50 R, B 50 L for passing-beam (or 25R, 50 L, B 50 R for headlamps designed for left-hand traffic);
- (b) In the case of a headlamp with a symmetrical beam pattern:
at the point for I_{\max} for driving beam and in points 0.50U/1.5L and 0.50U/1.5R, 50R, 50L for Class B passing beam and in points 0.86D-3.5R, 0.86D-3.5L, 0.50U-1.5L and 0.50U-1.5R for Classes C, D and E, for passing beam;
- (c) In the case of a front fog lamps:
at the point of maximum illumination in zone D (I_{\max}) and in the point HV;
- (d) In the case of an AFS:
at the point for I_{\max} for driving-beam and in points 25L, 50V, B 50 L (or R), whichever applies for passing-beam;

A complete sample shall be tested for stability of photometric performance in operation.

1.1. In the case of headlamps or front fog lamps:

"Complete sample" shall be understood to mean the complete lamp itself including ballast(s) and those surrounding body parts, light sources or LED module(s) which could influence its thermal dissipation.

1.2. In the case of an AFS:

- (a) "Complete sample" shall be understood to mean the complete right and left side of a system itself including electronic light source control-gear(s) and/or supply and operating device(s) and those surrounding body parts and lamps which could influence its thermal dissipation. Each installation unit of the system and lamp(s) and/or LED module, if any, of the complete system may be tested separately.
- (b) "Test sample" in the following text means correspondingly either the "complete sample" or the installation unit under test.
- (c) The expression "light source" shall be understood to comprise also any single filament of a filament light source, LED light source, LED modules or light emitting parts of a LED light source or LED module

- 1.3. The tests shall be carried out:
- (a) In a dry and still atmosphere at an ambient temperature of $23\text{ °C} \pm 5\text{ °C}$, the test sample being mounted on a base representing the correct installation on the vehicle;
 - (b) In case of replaceable light sources: using mass production filament light sources, which have been aged for at least one hour, or mass production gas-discharge light sources, which have been aged for at least 15 hours or mass production LED light source and LED modules which have been aged for at least 48 hours and cooled down to ambient temperature before starting the tests as specified in this Regulation. The LED modules supplied by the applicant shall be used.
 - (c) In the case of an AFS providing an adaptation of the driving-beam, the driving-beam shall be in the maximum condition if activated.
- 1.4. The measuring equipment shall be equivalent to that used during type approval tests. The AFS or part(s) thereof shall, prior to the subsequent tests, be set to the neutral state.
- The test sample shall be operated without being dismantled from or readjusted in relation to its test fixture. The light source used shall be a light source of the category specified for that headlamp.
2. Test for stability of photometric performance
- 2.1. Clean device
- The device shall be operated for 12 hours as described in paragraph 2.1.1. and checked as prescribed in paragraph 2.1.2.
- 2.1.1. Test procedure ¹
- 2.1.1.1. The device shall be operated for a period according to the specified time, so that:
- (a) In the case where a device is designed to provide only one lighting function (driving beam or passing beam or front fog lamp) and not more than one class in case of passing beam, the corresponding light source(s) is/are lit for the time,² specified in paragraph 2.1.;
 - (b) In the case where a device is designed to provide a passing-beam and one or more driving-beams or in the case of a headlamp with a passing-beam and a front fog lamp:
 - (i) The device shall be subjected to the following cycle until the time specified is reached as follows:
 - 15 minutes, principal passing-beam lit
 - 5 minutes, all functions lit

¹ For the test schedule see Annex 7, Appendix 1.

² When the tested headlamp includes signaling lamps, the latter shall be lit for the duration of the test, except for a daytime running lamp. In the case of a direction indicator lamp, it shall be lit in flashing mode with an on/ off time of approximately one to one.

- (ii) If the applicant declares that the headlamp is to be used with only the passing-beam lit or only the driving-beam(s) lit³ at a time, the test shall be carried out in accordance with this condition, activating¹ successively the passing-beam half of the time and the driving-beam(s) (simultaneously) for half the time specified in paragraph 2.1.
- (iii) In the case of a passing beam and a driving beam provided by the same gas-discharge light source, the cycle will be:
 - 15 minutes, passing beam lit
 - 5 minutes, all driving beam contributors lit.
- (c) In case of an AFS,
 - (i) Where a test sample provides more than one function or class of passing beam according to this Regulation: if the applicant declares that each specified function or class of passing beam of the test sample has its own light source(s), being exclusively lit² at a time, the test shall be carried out in accordance with this condition, activating¹ the most power consuming mode of each specified function or class of passing beam successively for the same (equally divided) part of the time specified in paragraph 2.1.
 - (ii) In all other cases, ^{1, 2} the test sample shall be subjected to the following cycle test for each, the mode(s) of class C passing beam, the class V passing beam, the class E passing beam and the class W passing beam, whatever is provided or partly provided by the test sample, for the same (equally divided) part of the time specified in paragraph 2.1.:
 - 15 minutes, first, e.g. class C passing beam mode lit with its most power-consuming mode for straight road conditions;
 - 5 minutes, same passing beam mode lit as before and, additionally, all light sources⁴ of the test sample, which are possible to be lit at the same time, according to the applicant's declaration;

after having reached the said (equally divided) part of the time specified in paragraph 2.1., the above test cycle shall be performed with the second, third and fourth class of passing beam, if applicable, in the above order.
- (d) In the case of a headlamp with a front fog lamp and one or more driving-beams:
 - (i) The headlamp shall be subjected to the following cycle until the time specified is reached:

³ Should additional light sources be simultaneously lit when headlamp flashing is used, this shall not be considered as being normal use of light sources.

⁴ All light sources of lighting functions even if no approval is sought according to this Regulation must be taken into account, except those covered by footnote 3.

- 15 minutes, front fog lamp lit;
 - 5 minutes, all functions lit.
- (ii) If the applicant declares that the headlamp is to be used with only the front fog lamp lit or only the driving-beam(s) lit² at a time, the test shall be carried out in accordance with this condition, activating¹ successively the front fog lamp half of the time and the driving-beam(s) (simultaneously) for half the time specified in paragraph 2.1.
- (e) In the case where a test sample includes other grouped lighting function(s), all the individual functions shall be lit simultaneously for the time specified in (a) or (b) above for individual lighting functions, according to the manufacturer's specifications.
- (f) In the case of a headlamp with a passing-beam, one or more driving-beams and a front fog lamp:
- (i) The headlamp shall be subjected to the following cycle until the time specified is reached:
 - 15 minutes, principal passing-beam lit;
 - 5 minutes, all functions lit.
 - (ii) If the applicant declares that the headlamp is to be used with only the passing-beam lit or only the driving-beam(s)² lit at a time, the test shall be carried out in accordance with this condition, activating¹ successively the principal passing-beam half of the time and the driving-beam(s) for half the time specified in paragraph 2.1., while the front fog lamp is subjected to a cycle of 15 minutes off and 5 minutes lit for half of the time and during the operation of the driving-beam;
 - (iii) If the applicant declares that the headlamp is to be used with only the passing-beam lit or only the front fog lamp² lit at a time, the test shall be carried out in accordance with this condition, activating¹ successively the principal passing-beam half of the time and the front fog lamp for half of the time specified in paragraph 2.1., while the driving-beam(s) is(are) subjected to a cycle of 15 minutes off and 5 minutes lit for half of the time and during the operation of the principal passing-beam;
 - (iv) If the applicant declares that the headlamp is to be used with only the passing-beam lit or only the driving-beam(s)² lit or only the front fog lamp² lit at a time, the test shall be carried out in accordance with this condition, activating¹ successively the principal passing-beam one third of the time, the driving-beam(s) one third of the time and the front fog lamp for one third of the time specified in paragraph 2.1.
- (g) In the case of a passing-beam designed to provide bend lighting with the addition of light source(s) or LED module(s), it/they shall be switched on for one minute, and switched off for nine minutes during the activation of the passing-beam only (see Appendix 1 of this Annex).

If the headlamp has several additional light sources used to produce bend lighting, the test shall be carried out with the combination of light source(s) that represents the most severe operating condition.

- (h) In the case that the driving beam uses several light sources and if the applicant declares that a part of the driving beam (one of these additional light sources) will be used exclusively for short time signals (flash to pass), the test shall be carried out without this part of the driving beam.

2.1.1.2. Test voltage

The voltage shall be applied to the terminals of the test sample as follows:

- (a) In case of replaceable filament light source(s) operated directly under vehicle voltage system conditions:

The test shall be performed at 6.3 V, 13.2 V or 28.0 V as applicable except if the applicant specifies that the test sample may be used at a different voltage. In this case, the test shall be carried out with the filament light source operated at the highest voltage that can be used.

- (b) In case of replaceable gas discharge light source(s): The test voltage for the electronic light source control-gear or the light source In case the ballast is integrated with the light source is 13.2 ± 0.1 volts for 12 V vehicle voltage system, or otherwise specified in the application for approval.
- (c) In the case of non-replaceable light source operated directly under vehicle voltage system conditions: All measurements on lighting units equipped with non-replaceable light sources (filament light sources and/ or others) shall be made at 6.3 V, 13.2 V or 28.0 V or at other voltages according to the vehicle voltage system as specified by the applicant respectively.
- (d) In the case of light sources, replaceable or non-replaceable, being operated independently from vehicle supply voltage and fully controlled by the system, or, in the case of light sources supplied by a supply and operating device, the test voltages as specified above shall be applied to the input terminals of that device. The test laboratory may require from the manufacturer the supply and operating device or a special power supply needed to supply the light source(s).
- (e) LED light source(s) and LED module(s) shall be measured at 6.75 V, 13.2 V or 28.0 V respectively, if not otherwise specified within the pertinent Regulation. LED light source(s) and LED module(s) operated by an electronic light source control gear, shall be measured as specified by the applicant.
- (f) Where signalling lamps are grouped, combined or reciprocally incorporated into the test sample and operating at voltages other than the nominal rated voltages of 6 V, 12 V or 24 V respectively, the voltage shall be adjusted as declared by the manufacturer for the correct photometric functioning of that lamp.
- (g) For a gas-discharge light source, the test voltage for the ballast or for the light source in case the ballast is integrated with the light source is 13.2 ± 0.1 volts for 12 V network system, or otherwise specified in the application for approval.

2.1.2. Test results

2.1.2.1. Visual inspection

Once the headlamp has been stabilized to the ambient temperature, the headlamp lens and the external lens, if any, shall be cleaned with a clean, damp cotton cloth. It shall then be inspected visually; no distortion, deformation, cracking or change in colour of either the headlamp lens or the external lens, if any, shall be noticeable.

2.1.2.2. Photometric test

To comply with the requirements, the photometric values shall be verified in the following points:

2.1.2.2.1. In the case of a headlamp with an asymmetrical beam pattern:

(a) Passing-beam, except for AFS system:

- 50 R - B 50 L – 25L for headlamps designed for right-hand traffic;
- 50 L - B 50 R – 25R for headlamps designed for left-hand traffic.

(b) Passing-beam, for AFS system:

Class C passing beam and each specified other passing beam class:
50V, B50L, and 25RR, if applicable

(c) Driving-beam: Point I_{max}

Another aiming may be carried out to allow for any deformation of the headlamp base due to heat (the change of the position of the cut-off line is covered in paragraph 3. of this Annex).

Except for point B 50 L, a 10 per cent discrepancy between the photometric characteristics and the values measured prior to the test is permissible including the tolerances of the photometric procedure. The value measured at point B 50 L shall not exceed the photometric value measured prior to the test by more than 170 cd.

2.1.2.2.2. In the case of a head lamp with a symmetrical beam pattern:

(a) Class B headlamp:

- Passing beam: 50R - 50L - 0.50U/1.5L and 0.50U/1.5R.
- Driving beam: Point of I_{max}

(b) For Classes C, D and E headlamp:

- Passing beam: 0.86D/3.5R - 0.86D/3.5L - 0.50U/1.5L and 1.5R.

(c) Driving beam: Point of I_{max}

Another aiming may be carried out to allow for any deformation of the headlamp base due to heat (the change of the position of the cut-off line is covered in paragraph 3. of this Annex).

Except for points 0.50U/1.5L and 0.50U/1.5R, a 10 per cent discrepancy between the photometric characteristics and the values measured prior to the test is permissible including the tolerances of the photometric procedure. The

value measured at points 0.50U/1.5L and 0.50U/1.5R shall not exceed the photometric value measured prior to the test by more than 255cd.

- 2.1.2.2.3. In the case of front fog lamps on line 5 at point $h = 0$ and the point of I_{\max} in zone D.

Another aiming may be carried out to allow for any deformation of the front fog lamp base due to heat (the change of the position of the cut-off line is covered in paragraph 3. of this Annex).

A 10 per cent discrepancy between the photometric characteristics and the values measured prior to the test is permissible including the tolerances of the photometric procedure.

- 2.2. Dirty headlamp

After being tested as specified in paragraph 2.1., the headlamp shall be operated for one hour as described in paragraph 2.1.1. for each function or class of passing beam⁵ after being prepared as prescribed in paragraph 2.2.1., and checked as prescribed in paragraph 2.1.2., after each test a sufficient cooling down period must be assured.

- 2.2.1. Preparation of the headlamp

- 2.2.1.1. Test mixture:

See Appendix 2 to this Annex

- 2.2.1.2. Application of the test mixture to the headlamp

The test mixture shall be uniformly applied to the entire light-emitting surface of the headlamp and then left to dry. This procedure shall be repeated until the illumination value has dropped to 15-20 per cent of the values measured for each following point under the conditions described below:

- (a) In the case of a headlamp with an asymmetrical beam pattern:
 - (i) Point of I_{\max} in passing-beam/driving-beam and in driving-beam only;
 - (ii) 50 R and 50 V for a headlamp producing only a passing-beam, designed for right-hand traffic;
 - (iii) 50 L and 50 V for a headlamp producing only a passing-beam, designed for left-hand traffic;
 - (iv) 50V for a class C passing beam of AFS system, and each specified passing beam mode.
- (b) In the case of a headlamp with a symmetrical beam pattern:
 - (i) For Class B headlamp:
 - Passing beam / driving beam and driving beam only:
Point of I_{\max}
 - Passing beam only: B 50 and 50 V

⁵ The class W passing beam, if any, is disregarded for lighting units providing or contributing to any other passing beam class or lighting function.

- (ii) For Class C, D and E headlamp:
 - Passing beam/driving beam and driving beam only:
Point of I_{\max}
 - Passing beam only: 0.50U/1.5L and 1.5R and 0.86D/V
 - (c) In the case of a front fog lamps:
 - point of I_{\max} in zone D.
3. Test for change in vertical position of the cut-off line under the influence of heat
- This test consists of verifying that the vertical drift of the cut-off line under the influence of heat does not exceed a specified value for an operating headlamp producing a passing-beam, for front fog lamps, or in the case of an AFS for a system or part(s) of emitting a class C (basic) passing-beam, or each specified passing-beam mode.
- The device tested in accordance with paragraph 2., shall be subjected to the test described in paragraph 3.1., without being removed from or readjusted in relation to its test fixture.
- If the AFS consists of more than one lighting unit or more than one assembly of lighting units which provide a cut-off, each of these is understood to be a test sample for the purpose of this test and must be tested separately.
- If the AFS has a moving optical part, only the position closest to the average vertical angular stroke and/or the initial position according to the neutral state is chosen for this test.
- The test is confined to signal input conditions corresponding to a straight road, only.
- 3.1. Test Procedure
- 3.1.1. For the purpose of this test, the voltage shall be adjusted as specified in paragraph 2.1.1.2.;
- The test shall be carried out in a dry and still atmosphere at an ambient temperature of $23\text{ }^{\circ}\text{C} \pm 5\text{ }^{\circ}\text{C}$.
- The device shall be operated without being dismantled from or readjusted in relation to its test fixture. (For the purpose of this test, the voltage shall be adjusted as specified in paragraph 2.1.1.2.):
- (a) Using a mass production filament light source as submitted with the device, which has been aged for at least 1 hour;
 - (b) Using mass production LED light source(s) and/or the LED module(s) as submitted with the device, which has been aged for at least 48 hours;
 - (c) Using a mass production gas-discharge light source which has been aged for at least 15 hours.
- 3.1.2. In the case of a device with an asymmetrical beam pattern:
- the position of the "cut-off" line in its horizontal part (between V-V and the vertical lines passing through point B 50 L for right-hand traffic or B 50 R for left-hand traffic) shall be verified 3 minutes (r3) and 60 minutes (r60) respectively after operation.

3.1.3. In the case of a headlamp with a symmetrical beam pattern: the position of the "cut-off" line in its horizontal part (between V-V and the vertical lines passing through point 50 L and 50 R for Class BS headlamp, 3.5 L and 3.5 R for Class CS, DS and ES headlamp) shall be verified 3 minutes (r3) and 60 minutes (r60) respectively after operation.

3.1.4. In the case of a front fog lamps: the position of the "cut-off" line between a point situated 3.0 degrees left and a point situated 3.0 degrees right of the cut-off line V-V shall be verified 3 minutes (r3) and 60 minutes (r60) respectively after operation.

The measurement of the variation in the cut-off line position as described above shall be carried out by any method giving acceptable accuracy and reproducible results.

3.2. Test results

3.2.1. The result, expressed in milliradians (mrad), shall be considered as acceptable when:

- (a) In case of headlamps or AFS, the absolute value $\Delta r_1 = |r_3 - r_{60}|$ recorded on the device is not more than 1.0 mrad ($\Delta r_1 \leq 1.0$ mrad) upward and not more than 2.0 mrad ($\Delta r_1 \leq 2.0$ mrad) downwards.
- (b) In case of front fog lamps, the absolute value $\Delta r_1 = |r_3 - r_{60}|$ recorded on this device is not more than 2.0 mrad ($\Delta r_1 \leq 2.0$ mrad).

3.2.2. However, if the result does not comply with the requirements in paragraph 3.2.1. and does not exceed the values in Table A7-1, a further sample mounted on a test fixture representative of the correct installation on the vehicle shall be tested as described in paragraph 3.1. after being subjected three consecutive times to the cycle as described below, in order to stabilise the position of the mechanical parts of the device:

- (a) Operation of the device for one hour (the voltage shall be adjusted as specified in paragraph 2.1.1.2.);
- (b) One hour period with the lamp switched off.

After these three cycles, the device shall be considered as acceptable if the absolute values Δr measured according to paragraph 3.2. on this further sample meet the requirements in paragraph 3.2.1.

Table A7-1
Movement values

<i>Movement</i>	<i>Device</i>	<i>Value</i>
Upward	Headlamp or AFS	1.5 mrad
	Front fog lamp	3.0 mrad
Downward	All	3.0 mrad

Annex 7 - Appendix 1

Overview of operational periods concerning test for stability of photometric performance

Abbreviations: P: passing-beam lamp
 D: driving-beam lamp (D₁ + D₂ means two driving-beams)
 F: front fog lamp
 — — — — — means a cycle of 15 minutes off and 5 minutes lit
 means a cycle of 9 minutes off and 1 minute lit

All following grouped headlamps and front fog lamps together with the added marking symbols are given as examples and are not exhaustive.

1. P or D or F

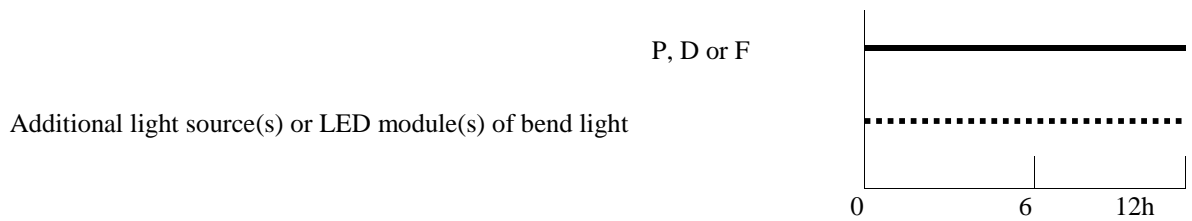

2. P+F or P+D or P+D₁+D₂ or P+D+F or P+D₁+D₂+ F

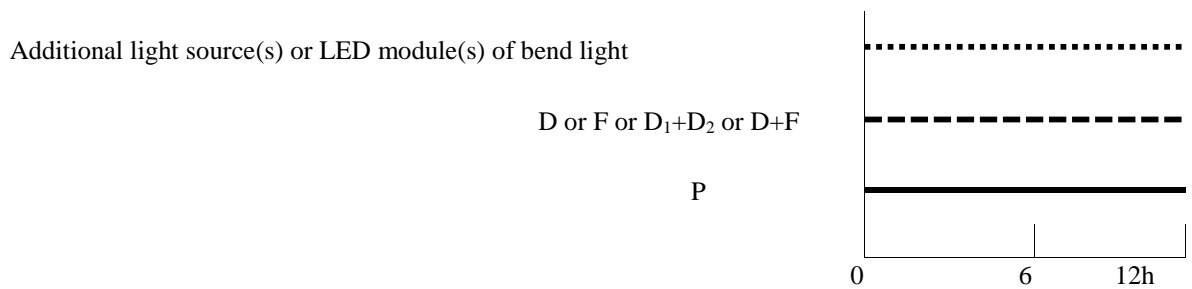

3. P/F or P/D or P/ D₁+D₂

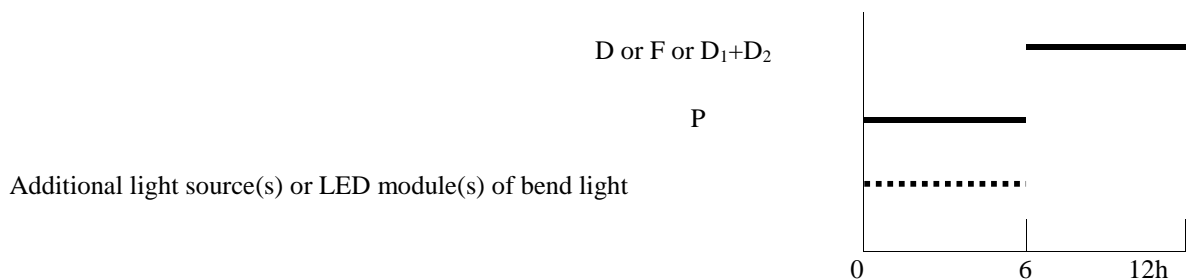

4. $D+F$ or D_1+D_2+F

Additional light source(s) or LED module(s) of bend light

D or D_1+D_2

F

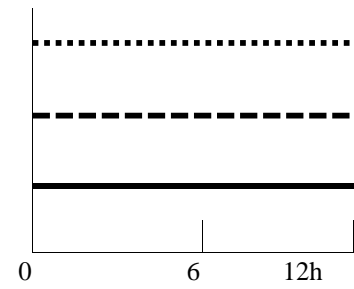

5. D/F or D_1+D_2/F

Additional light source(s) or LED module(s) of bend light

D or D_1+D_2

F

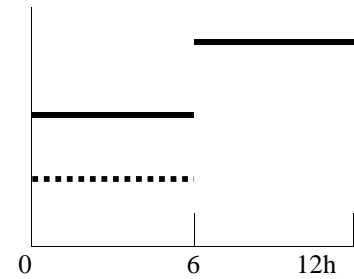

6. $P/D+F$ or P/D_1+D_2+F

Additional light source(s) or LED module(s) of bend light

F

D or D_1+D_2

P

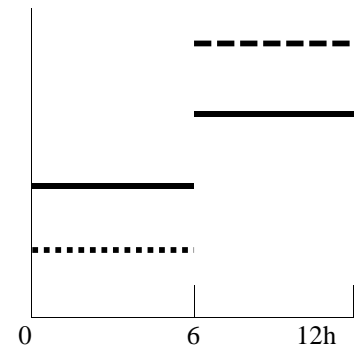

7. $P+D/F$ or $P+D_1+D_2/F$

Additional light source(s) or LED module(s) of bend light

F

D or D_1+D_2

P

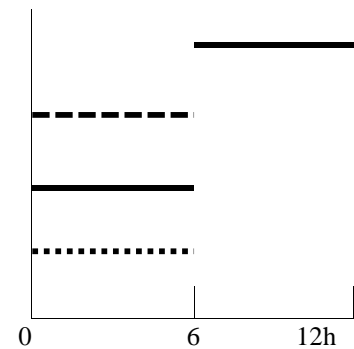

8. P/D/F or P/D₁+D₂/F

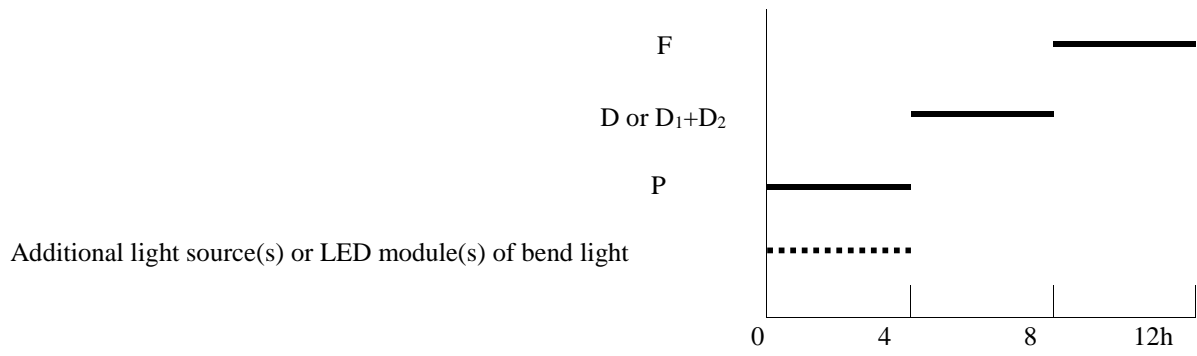

Annex 7 - Appendix 2

Test mixture for dirty headlamp test

1. For devices with the outer lens made of glass:
The mixture of water and a polluting agent to be applied to the device shall be composed of:
 - (a) 9 parts by weight of silica sand with a particle size of 0-100 μm ;
 - (b) 1 part by weight of vegetal carbon dust produced from beech wood with a particle size of 0-100 μm ;
 - (c) 0.2 parts by weight of NaCMC;¹ and
 - (d) 5 parts by weight of sodium chloride (pure at 99 per cent);
 - (e) an appropriate quantity of distilled water, with a conductivity of ≤ 1 mS/m.The mixture shall not be more than 14 days old.
2. For devices with outer lens made of plastic material:
The mixture of water and polluting agent to be applied to the device shall be composed of:
 - (a) 9 parts by weight of silica sand with a particle size of 0-100 μm ;
 - (b) 1 part by weight of vegetal carbon dust produced from beech wood with a particle size of 0-100 μm ;
 - (c) 0.2 parts by weight of NaCMC;¹ and
 - (d) 5 parts by weight of sodium chloride (pure at 99 per cent);
 - (e) 13 parts by weight of distilled water with a conductivity of ≤ 1 mS/m; and
 - (f) 2 ± 1 drops by weight of surfactant.²The mixture shall not be more than 14 days old.

¹ NaCMC represents the sodium salt of carboxymethylcellulose, customarily referred to as CMC. The NaCMC used in the dirt mixture shall have a degree of substitution (DS) of 0.6-0.7 and a viscosity of 200-300 cP for a 2 per cent solution at 20° C.

² The tolerance on quantity is due to the necessity of obtaining a dirt that correctly spreads out on all the plastic lens.

Annex 8

Requirements for road illumination devices (except cornering lamps) incorporating lenses of plastic material - testing of lens or material samples

1. General administrative requirements:
 - 1.1. A test report shall be prepared on the base of this Annex, covering the test and test results as described below for the tests 3.1 to 3.5, which will be added to the test report and the documentation to a specific device for approval.

The road illumination device used for this test shall be noted in the test report.
 - 1.2. Every application for approval shall be accompanied by:
 - 1.2.1. For the test of plastic material of which the lenses are made: Fourteen lenses;
 - 1.2.1.1. Ten of these lenses may be replaced by ten samples of material at least 60 x 80 mm in size, having a flat or convex outer surface and a substantially flat area (radius of curvature not less than 300 mm) in the middle measuring at least 15 x 15 mm;
 - 1.2.1.2. Every such lens or sample of material shall be produced by the method to be used in mass production;
 - 1.2.2. An optical assembly, if applicable, to which the lenses can be fitted in accordance with the manufacturer's instructions.
 - 1.2.3. For testing the ultraviolet (UV)-resistance of light transmitting components made of plastic material against UV radiation of LED modules inside the headlamp:

One sample of each of the relevant material as being used in the road illumination device or one road illumination device sample containing these. Each material sample shall have the same appearance and surface treatment, if any, as intended for use in the headlamp to be approved;

The UV-resistance testing of internal materials to light source radiation is not necessary if no LED modules other than low-UV-types as specified in Annex 9 are being applied or if provisions are taken, to shield the relevant device components from UV radiation, e.g. by glass filters.
2. General requirements
 - 2.1. The samples supplied pursuant to paragraph 1.2. shall satisfy the requirements indicated in paragraphs 3.1. to 3.6.
 - 2.2. The two samples of complete road illumination devices supplied pursuant to paragraph 3.1.3.4. of this Regulation and incorporating lenses of plastic material shall, with regard to the lens material, satisfy the requirements indicated in paragraph 3.7.
 - 2.3. The samples (lenses of plastic material or samples of material) shall be subjected, with the optical assembly to which they are intended to be fitted

(where applicable), to approval tests in the chronological order indicated in Table A8-1.

- 2.4. However, if the lamp manufacturer can prove that the product has already passed the tests prescribed in paragraphs 3.1. to 3.5., or the equivalent tests pursuant to another regulation, those tests need not be repeated; only the tests prescribed in Table A8-2 shall be mandatory.

3. Specific Test Requirements

3.1. Resistance to temperature changes

- 3.1.1. Three new samples (lenses) shall be subjected to five cycles of temperature and humidity (RH = relative humidity) change in accordance with the following programme:

- (a) 3 hours at $40\text{ °C} \pm 2\text{ °C}$ and 85-95 per cent RH;
- (b) 1 hour at $23\text{ °C} \pm 5\text{ °C}$ and 60-75 per cent RH;
- (c) 15 hours at $-30\text{ °C} \pm 2\text{ °C}$;
- (d) 1 hour at $23\text{ °C} \pm 5\text{ °C}$ and 60-75 per cent RH;
- (e) 3 hours at $80\text{ °C} \pm 2\text{ °C}$;
- (f) 1 hour at $23\text{ °C} \pm 5\text{ °C}$ and 60-75 per cent RH;

Before this test, the samples shall be kept at $23\text{ °C} \pm 5\text{ °C}$ and 60-75 per cent RH for at least four hours.

Note: The periods of one hour at $23\text{ °C} \pm 5\text{ °C}$ shall include the periods of transition from one temperature to another which are needed in order to avoid thermal shock effects.

3.1.2. Photometric measurements

- 3.1.2.1. Photometric measurements shall be carried out on the samples before and after the test.

- 3.1.2.2. These measurements shall be made using a standard (étalon) light source and/or LED module(s), or if applicable with a standard gas-discharge light source, as present in the road illumination device, at the following points:

- (a) In the case of classes A, B and D:
 - B 50 L and 50 R for the passing-beam (B 50 R and 50 L in the case of headlamps intended for left-hand traffic);
 - I_{\max} for the driving-beam.
- (b) In the case of AFS:
 - B50L and 50V for the Class C passing-beam lighting;
 - I_{\max} for the driving-beam of a system
- (c) In the case of classes BS, CS, DS and ES:
 - B 50, 50L and 50R for Class BS headlamp, 0.86D/3.5R, 0.86D/3.5L, 0.50U/1.5L and 1.5R for Class CS, DS and ES headlamps for the passing beam or a passing/driving lamp;
 - I_{\max} for the driving beam of a driving lamp or a passing/driving lamp;

- (d) In the case of front fog lamps:
 - intersection VV line with line 6 and
 - intersection VV line with line 4.

3.1.2.3. Results

The variation between the photometric values measured on each sample before and after the test shall not exceed 10 per cent including the tolerances of the photometric procedure.

3.2. Resistance to atmospheric and chemical agents

3.2.1. Resistance to atmospheric agents

Three new samples (lenses or samples of material) shall be exposed to radiation from a source having a spectral energy distribution similar to that of a black body at a temperature between 5,500 K and 6,000 K. Appropriate filters shall be placed between the source and the samples so as to reduce as far as possible radiations with wave lengths smaller than 295 nm and greater than 2,500 nm. The samples shall be exposed to an energetic illumination of $1,200 \text{ W/m}^2 \pm 200 \text{ W/m}^2$ for a period such that the luminous energy that they receive is equal to $4,500 \text{ MJ/m}^2 \pm 200 \text{ MJ/m}^2$. Within the enclosure, the temperature measured on the black panel placed on a level with the samples shall be $50 \text{ }^\circ\text{C} \pm 5 \text{ }^\circ\text{C}$. In order to ensure a regular exposure, the samples shall revolve around the source of radiation at a speed between 1 and 5 1/min.

The samples shall be sprayed with distilled water of conductivity lower than 1 mS/m at a temperature of $23 \text{ }^\circ\text{C} \pm 5 \text{ }^\circ\text{C}$, in accordance with the following cycle:

spraying: 5 minutes; drying: 25 minutes.

3.2.2. Resistance to chemical agents

After the test described in paragraph 3.2.1. and the measurement described in paragraph 3.2.3.1. have been carried out, the outer face of the said three samples shall be treated as described in paragraph 3.2.2.2. with the mixture defined in paragraph 3.2.2.1.

3.2.2.1. Test mixture

The test mixture shall be composed of 61.5 per cent n-heptane, 12.5 per cent toluene, 7.5 per cent ethyl tetrachloride, 12.5 per cent trichloroethylene and 6 per cent xylene (volume per cent).

3.2.2.2. Application of the test mixture

Soak a piece of cotton cloth (as per ISO 105) until saturation with the mixture defined in paragraph 3.2.2.1. and, within 10 seconds, apply it for 10 minutes to the outer face of the sample at a pressure of 50 N/cm^2 , corresponding to an effort of 100 N applied on a test surface of 14 x 14 mm.

During this 10-minute period, the cloth pad shall be soaked again with the mixture so that the composition of the liquid applied is continuously identical with that of the test mixture prescribed.

During the period of application, it is permissible to compensate the pressure applied to the sample in order to prevent it from causing cracks.

3.2.2.3. Cleaning

At the end of the application of the test mixture, the samples shall be dried in the open air and then washed with the solution described in paragraph 3.4.1. (Resistance to detergents) at $23\text{ °C} \pm 5\text{ °C}$.

Afterwards the samples shall be carefully rinsed with distilled water containing not more than 0.2 per cent impurities at $23\text{ °C} \pm 5\text{ °C}$ and then wiped off with a soft cloth.

3.2.3. Results

3.2.3.1. After the test of resistance to atmospheric agents, the outer face of the samples shall be free from cracks, scratches, chipping and deformation, and the mean variation in transmission $\Delta t = \frac{T_2 - T_3}{T_2}$, measured on the three samples according to the procedure described in Appendix 2 to this Annex shall not exceed 0.020 ($\Delta t_m \leq 0.020$).

3.2.3.2. After the test of resistance to chemical agents, the samples shall not bear any traces of chemical staining likely to cause a variation of flux diffusion, whose mean variation $\Delta d = \frac{T_5 - T_4}{T_2}$, measured on the three samples according to the procedure described in Appendix 2 to this Annex shall not exceed 0.020 ($\Delta d_m \leq 0.020$).

3.3. Resistance to light source radiations

If necessary the following test shall be done:

Flat samples of each light transmitting plastic component of the road illumination device are exposed to the light of the light source(s). The parameters such as angles and distances of these samples shall be the same as in the road illumination device. These samples shall have the same colour and surface treatment, if any, as the parts of the road illumination device.

After 1,500 hours of continuous operation, the colorimetric requirements of the transmitted light must be met with a new light source, and the surfaces of the samples shall be free of cracks, scratches, scalings or deformation.

The UV-resistance testing of internal materials to light source radiation is not necessary if light sources according to UN Regulation No. 37 and/or low-UV-type gas discharge light sources and/or low-UV-type LED modules are being applied or if provisions are taken, to shield the relevant system components from UV radiation, e.g. by glass filters.

3.4. Resistance to detergents and hydrocarbons

3.4.1. Resistance to detergents

The outer face of three samples (lenses or samples of material) shall be heated to $50\text{ °C} \pm 5\text{ °C}$ and then immersed for five minutes in a mixture maintained at $23\text{ °C} \pm 5\text{ °C}$ and composed of 99 parts distilled water containing not more than 0.02 per cent impurities and one part alkylaryl sulphonate.

At the end of the test, the samples shall be dried at $50\text{ °C} \pm 5\text{ °C}$. The surface of the samples shall be cleaned with a moist cloth.

3.4.2. Resistance to hydrocarbons

The outer face of these three samples shall then be lightly rubbed for one minute with a cotton cloth soaked in a mixture composed of 70 per cent n-heptane and 30 per cent toluene (volume per cent), and shall then be dried in the open air.

3.4.3. Results

After the above two tests have been performed successively, the mean value of the variation in transmission $\Delta t = \frac{T_2 - T_3}{T_2}$, measured on the three samples

according to the procedure described in Appendix 2 shall not exceed 0.010 ($\Delta t_m \leq 0.010$).

3.5. Resistance to mechanical deterioration

3.5.1. Mechanical deterioration method

The outer face of the three new samples (lenses) shall be subjected to the uniform mechanical deterioration test by the method described in Appendix 3.

3.5.2. Results

After this test, the variations:

in transmission: $\Delta t = \frac{T_2 - T_3}{T_2}$,

and in diffusion: $\Delta d = \frac{T_5 - T_4}{T_2}$,

shall be measured according to the procedure described in Appendix 2 in the area specified in paragraph 1.2.1.1. The mean value of the three samples shall be such that:

$$\Delta t_m \leq 0.100;$$

$$\Delta d_m \leq 0.050.$$

3.6. Test of adherence of coatings, if any

3.6.1. Preparation of the sample

A surface of 20 mm x 20 mm in area of the coating of a lens shall be cut with a razor blade or a needle into a grid of squares approximately 2 mm x 2 mm. The pressure on the blade or needle shall be sufficient to cut at least the coating.

3.6.2. Description of the test

Use an adhesive tape with a force adhesion of 2 N/(cm of width) ± 20 per cent measured under the standardized conditions specified in Appendix 4. This adhesive tape, which shall be at least 25 mm wide, shall be pressed for at least five minutes to the surface prepared as prescribed in paragraph 3.6.1.

Then the end of the adhesive tape shall be loaded in such a way that the force of adhesion to the surface considered is balanced by a force perpendicular to

that surface. At this stage, the tape shall be torn off at a constant speed of 1.5 m/s \pm 0.2 m/s.

3.6.3. Results

There shall be no appreciable impairment of the gridded area. Impairments at the intersections between squares or at the edges of the cuts shall be permitted, provided that the impaired area does not exceed 15 per cent of the gridded surface.

3.7. Tests of the complete road illumination device incorporating a lens of plastic material.

3.7.1. Resistance to mechanical deterioration of the lens surface.

3.7.1.1. Tests

The lens of sample No. 1 shall be subjected to the test described in paragraph 3.5.1. above.

3.7.1.2. Results

3.7.1.2.1 In case of classes A, B and D and AFS, after the test the results of photometric measurements carried out on the headlamp in accordance with this Regulation shall not exceed:

- (a) By more than 30 per cent the maximum values prescribed at points B 50 L and HV and by more than 10 per cent below the minimum values prescribed at point 75 R (in the case of headlamps intended for left-hand traffic, the points to be considered are B 50 R, HV and 75 L)

or

- (b) By more than 10 per cent below the minimum values prescribed for HV in the case of a headlamp producing driving beam only.

3.7.1.2.2. In the case of Classes BS, CS, DS and ES, after the test, the results of photometric measurements carried out on the headlamp in accordance with this Regulation shall not exceed:

- (a) By more than 30 per cent the maximum values prescribed at point HV and not be more than 10 per cent below the minimum values prescribed at point 50 L and 50 R for Class BS headlamp, 0.86D/3.5R, 0.86D/3.5L for Classes CS, DS and ES headlamp

or

- (b) By more than 10 per cent below the minimum values prescribed for HV in the case of a headlamp producing driving beam only.

3.7.1.2.3. In the case of fog lamps, after the test, the results of photometric measurements prescribed for lines 2 and 5 shall not exceed the maximum values prescribed by more than 30 per cent

3.7.2. Test of adherence of coatings, if any

The lens of sample No. 2 shall be subjected to the test described in paragraph 3.6.

4. Verification of the conformity of production
- 4.1. With regard to the materials used for the manufacture of lenses, the road illumination devices or installation units of a series shall be recognised as complying with this Regulation if:
 - 4.1.1. After the test for resistance to chemical agents and the test for resistance to detergents and hydrocarbons, the outer face of the samples exhibits no cracks, chipping or deformation visible to the naked eye (see paras. 3.2.2., 3.4.1. and 3.4.2.);
 - 4.1.2. After the test described in paragraph 3.7.1.1., the photometric values at the points of measurement considered in paragraph 3.7.1.2. are within the limits prescribed for conformity of production by this Regulation.
- 4.2. If the test results fail to satisfy the requirements, the tests shall be repeated on another sample of road illumination devices selected at random.

Annex 8 - Appendix 1

Chronological order of material tests

A. Tests on plastic materials (lenses or samples of material supplied pursuant to paragraph 1.2.).

Table A8-1

Chronological order of material tests

<i>Samples</i>	<i>Lenses or samples of material</i>										<i>Lenses</i>			
	1	2	3	4	5	6	7	8	9	10	11	12	13	14
Limited photometry											X	X	X	
Temperature change											X	X	X	
Limited photometry											X	X	X	
Transmission measurement	X	X	X	X	X	X	X	X	X					
Diffusion measurement	X	X	X				X	X	X					
Atmospheric agents	X	X	X											
Transmission measurement	X	X	X											
Chemical agents	X	X	X											
Diffusion measurements	X	X	X											
Detergents				X	X	X								
Hydrocarbons				X	X	X								
Transmission measurement				X	X	X								
Deterioration							X	X	X					
Transmission measurement							X	X	X					
Diffusion measurement							X	X	X					
Adherence														X
Resistance to light source radiations*										X				

* This test concerns front fog lamps equipped with gas-discharge light sources, headlamps and AFS.

Table A8-2
Tests on complete devices, systems or parts thereof (supplied pursuant to paragraph 3.1.3.4. of this Regulation)

<i>Tests</i>	<i>Complete devices, systems or parts thereof</i>	
	<i>Sample No.</i>	
	<i>1</i>	<i>2</i>
Deterioration	X	
Photometry	X	
Adherence		X

Annex 8 - Appendix 2

Method of measurement of the diffusion and transmission of light

1. Equipment (see figure A8-I)

The beam of a collimator K with a half divergence $\beta/2 = 17.4 \times 10^4$ rd is limited by a diaphragm D_τ with an opening of 6 mm against which the sample stand is placed.

A convergent achromatic lens L_2 , corrected for spherical aberrations links the diaphragm D_τ with the receiver R; the diameter of the lens L_2 shall be such that it does not diaphragm the light diffused by the sample in a cone with a half top angle of $\beta/2 = 14^\circ$.

An annular diaphragm D_D , with angles $\alpha_o/2 = 1^\circ$ and $\alpha_{max}/2 = 12^\circ$ is placed in an image focal plane of the lens L_2 .

The non-transparent central part of the diaphragm is necessary in order to eliminate the light arriving directly from the light source. It shall be possible to remove the central part of the diaphragm from the light beam in such a manner that it returns exactly to its original position.

The distance $L_2 D_\tau$ and the focal length F_2^1 of the lens L_2 shall be so chosen that the image of D_τ completely covers the receiver R.

When the initial incident flux is referred to 1,000 units, the absolute precision of each reading shall be better than 1 unit.

¹ For L_2 it is recommended to use a focal distance of about 80 mm.

Figure A8-I
Optical set up for measurement of variations in diffusion and transmission

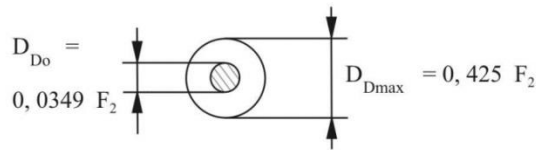
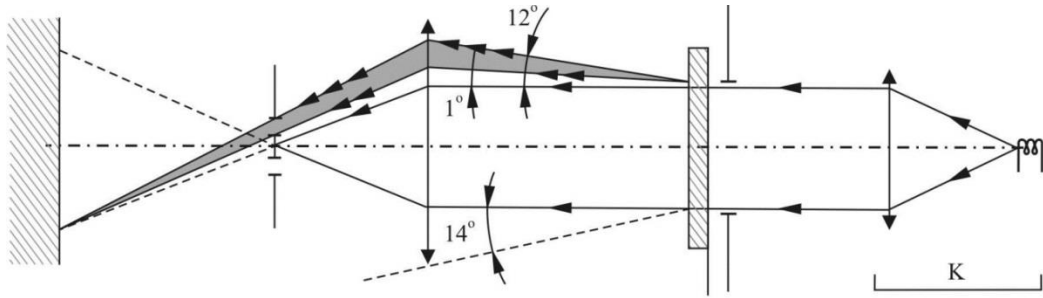

2. Measurements

The following readings shall be taken:

Table A8-3
Readings

Reading	With sample	With central part of D_D	Quantity represented
T ₁	No	No	Incident flux in initial reading
T ₂	Yes (before test)	No	Flux transmitted by the new material in a field of 24°
T ₃	Yes (after test)	No	Flux transmitted by the tested material in a field of 24°
T ₄	Yes (before test)	Yes	Flux diffused by the new material
T ₅	Yes (after test)	Yes	Flux diffused by the tested material

Annex 8 - Appendix 3

Spray testing method

1. Test equipment

1.1. Spray gun

The spray gun used shall be equipped with a nozzle 1.3 mm in diameter allowing a liquid flow rate of 0.24 ± 0.02 l/minute at an operating pressure of 6.0 bars $-0/+0.5$ bar.

Under these operation conditions the fan pattern obtained shall be 170 mm 50 mm in diameter on the surface exposed to deterioration, at a distance of 380 mm 10 mm from the nozzle.

1.2. Test mixture

The test mixture shall be composed of:

- (a) Silica sand of hardness 7 on the Mohr scale, with a grain size between 0 and 0.2 mm and an almost normal distribution, with an angular factor of 1.8 to 2;
- (b) Water of hardness not exceeding 205 g/m^3 for a mixture comprising 25 g of sand per litre of water.

2. Test

The outer surface of the lamp lenses shall be subjected once or more than once to the action of the sand jet produced as described above. The jet shall be sprayed almost perpendicular to the surface to be tested.

The deterioration shall be checked by means of one or more samples of glass placed as a reference near the lenses to be tested. The mixture shall be sprayed until the variation in the diffusion of light on the sample or samples measured by the method described in Appendix 2, is such that:

$$\Delta d = \frac{T_5 - T_4}{T_2} = 0.0250 \pm 0.0025$$

Several reference samples may be used to check that the whole surface to be tested has deteriorated homogeneously.

Annex 8 - Appendix 4

Adhesive tape adherence test

1. Purpose

This method allows to determine under standard conditions the linear force of adhesion of an adhesive tape to a glass plate.
2. Principle

Measurement of the force necessary to unstick an adhesive tape from a glass plate at an angle of 90°.
3. Specified atmospheric conditions

The ambient conditions shall be at $23\text{ °C} \pm 5\text{ °C}$ and 65 ± 15 per cent RH.
4. Test pieces

Before the test, the sample roll of adhesive tape shall be conditioned for 24 hours in the specified atmosphere (see para. 3. above).

Five test pieces each 400 mm long shall be tested from each roll. These test pieces shall be taken from the roll after the first three turns were discarded.
5. Procedure

The test shall be under the ambient conditions specified in paragraph 3.

Take the five test pieces while unrolling the tape radially at a speed of approximately 300 mm/s, then apply them within 15 seconds in the following manner:

Apply the tape to the glass plate progressively with a slight length-wise rubbing movement of the finger, without excessive pressure, in such a manner as to leave no air bubble between the tape and the glass plate.

Leave the assembly in the specified atmospheric conditions for 10 minutes.

Unstick about 25 mm of the test piece from the plate in a plane perpendicular to the axis of the test piece.

Fix the plate and fold back the free end of the tape at 90°. Apply force in such a manner that the separation line between the tape and the plate is perpendicular to this force and perpendicular to the plate.

Pull to unstick at a speed of $300\text{ mm/s} \pm 30\text{ mm/s}$ and record the force required.
6. Results

The five values obtained shall be arranged in order and the median value taken as a result of the measurement. This value shall be expressed in Newtons per centimetre of width of the tape.

Annex 9

Requirements for LED modules and Road Illumination Devices (except cornering lamps) including LED modules and/or LED light sources

1. General requirements for LED modules
 - 1.1. Each LED module sample submitted shall conform to the relevant requirements of this Regulation when tested with the supplied electronic light source control-gear(s), if any.
 - 1.2. LED module(s) shall be so designed as to be and to remain in good working order when in normal use. They shall moreover exhibit no fault in design or manufacture. A LED module shall be considered to have failed if any one of its LEDs has failed.
 - 1.3. LED module(s) shall be tamperproof.
 - 1.4. The design of removable LED module(s) shall be such that:
 - 1.4.1. When the LED module is removed and replaced by another module provided by the applicant and bearing the same light source module identification code, the photometric requirements of the headlamp or AFS system shall be met;
 - 1.4.2. LED modules with different light source module identification codes within the same lamp housing shall not be interchangeable.
2. Manufacture of LED modules
 - 2.1. The LED(s) on the LED module shall be equipped with suitable fixation elements.
 - 2.2. The fixation elements shall be strong and firmly secured to the LED(s) and the LED module.
3. Test conditions
 - 3.1. Application
 - 3.1.1. All samples shall be tested as specified in paragraph 4.
 - 3.1.2. The kind of light sources on a LED module shall be light-emitting diodes (LED) as defined in paragraph 2.7.1. of UN Regulation 48 in particular with regard to the element of visible radiation. Other kinds of light sources are not permitted.
 - 3.2. Operating conditions
 - 3.2.1. LED module operating conditions

All samples shall be tested under the conditions as specified in paragraph 4.6.4. of this Regulation. If not specified differently in this Annex LED modules shall be tested inside the device as submitted by the manufacturer.

3.2.2. LED light source operating conditions

All samples shall be tested under the conditions as specified in paragraph 4.6.3. of this Regulation.

3.2.3. Ambient temperature

For the measurement of electrical and photometric characteristics, the device shall be operated in a dry and still atmosphere at an ambient temperature of $23\text{ °C} \pm 5\text{ °C}$.

3.3. Ageing

Upon the request of the applicant the LED module shall be operated for 15 h and cooled down to ambient temperature before starting the tests as specified in this Regulation.

4. Specific requirements and tests

4.1. Colour rendering

4.1.1. Red content

In addition to provisions as described in paragraph 4.16. of this Regulation.

The minimum red content of the light of a LED module or a device incorporating LED module(s) tested (at 50 V for headlamps and AFS) shall be such that:

$$k_{\text{red}} = \frac{\int_{\lambda=610\text{ nm}}^{780\text{ nm}} E_e(\lambda) V(\lambda) d\lambda}{\int_{\lambda=380\text{ nm}}^{780\text{ nm}} E_e(\lambda) V(\lambda) d\lambda} \geq 0.05$$

where:

$E_e(\lambda)$ (unit: W) is the spectral distribution of the irradiance;

$V(\lambda)$ (unit: 1) is the spectral luminous efficiency;

λ (unit: nm) is the wavelength.

This value shall be calculated using intervals of one nanometre.

4.2. UV-radiation

The UV-radiation of a low-UV-type LED module shall be such that:

$$k_{\text{UV}} = \frac{\int_{\lambda=250\text{ nm}}^{400\text{ nm}} E_e(\lambda) S(\lambda) d\lambda}{k_m \int_{\lambda=380\text{ nm}}^{780\text{ nm}} E_e(\lambda) V(\lambda) d\lambda} \leq 10^{-5} \text{ W / lm}$$

where:

$S(\lambda)$ (unit: 1) is the spectral weighting function;

$k_m = 683 \text{ lm/W}$ is the maximum value of the luminous efficacy of radiation.

(For definitions of the other symbols see paragraph 4.1.1.).

This value shall be calculated using intervals of one nanometre. The UV-radiation shall be weighted according to the values as indicated Table A9-1:

Table A9-1

Table UV

Values according to "IRPA/INIRC Guidelines on limits of exposure to ultraviolet radiation". Wavelengths (in nanometres) chosen are representative; other values should be interpolated.

λ	$S(\lambda)$	λ	$S(\lambda)$	λ	$S(\lambda)$
250	0.430	305	0.060	355	0.000 16
255	0.520	310	0.015	360	0.000 13
260	0.650	315	0.003	365	0.000 11
265	0.810	320	0.001	370	0.000 09
270	1.000	325	0.000 50	375	0.000 077
275	0.960	330	0.000 41	380	0.000 064
280	0.880	335	0.000 34	385	0.000 053
285	0.770	340	0.000 28	390	0.000 044
290	0.640	345	0.000 24	395	0.000 036
295	0.540	350	0.000 20	400	0.000 030
300	0.300				

4.3. Temperature stability for device including LED light source(s) and/or LED module(s)

4.3.1. Luminous intensity

4.3.1.1. A photometric measurement of the device shall be made after 1 minute of operation for the specific function at the test point specified below. For these measurements, the aim can be approximate but must be maintained for before and after ratio measurements.

Test points to be measured:

Passing-beam: 25R in case of headlamps of classes A, B and D
50V in case of headlamps of classes AS, BS, CS, DS, ES
25RR in case of AFS

Driving-beam: H – V

Front fog lamps: horizontal 0° vertical 2.5°D

4.3.1.2. The lamp shall continue operation until photometric stability has occurred. The moment at which the photometry is stable is defined as the point in time at which the variation of the photometric value is less than 3 per cent within any 15 minutes period. After stability has occurred, aim for complete photometry shall be performed in accordance with the requirements of the specific device. Photometer the lamp at all test points required for the specific device.

- 4.3.1.3. Calculate the ratio between the photometric test point value determined in paragraph 4.3.1.1. and the point value determined in paragraph 4.3.1.2.
- 4.3.1.4. Once stability of photometry has been achieved, apply the ratio calculated above to each of the remainder of the test points to create a new photometric table that describes the complete photometry based on one minute of operation.
- 4.3.1.5. The luminous intensity values, measured after one minute and after photometric stability has occurred, shall comply with the minimum and maximum requirements.
- 4.3.2. Colour
 - The colour of the light emitted measured after one minute and measured after photometric stability has been obtained, as described in paragraph 4.3.1.2., shall both be within the required colour boundaries.
- 5. The measurement of the objective luminous flux of LED module(s) producing the principal passing-beam shall be carried out as follows:
 - 5.1. The LED module(s) shall be in the configuration as described in the technical specification as defined in paragraph 3.1.3. of this Regulation. Optical elements (secondary optics) shall be removed by the Technical Service at the request of the applicant by the use of tools. This procedure and the conditions during the measurements as described below shall be described in the test report.
 - 5.2. One module of each type shall be submitted by the applicant with the light source control gear, if applicable, and sufficient instructions.
 - Suitable thermal management (e.g. heat sink) may be provided, to simulate similar thermal conditions as in the corresponding headlamp or AFS application.
 - Before the test each LED module shall be aged at least for seventy-two hours under the same conditions as in the corresponding headlamp application.
 - In the case of use of an integrating sphere, the sphere shall have a minimum diameter of one meter, and at least ten times the maximum dimension of the LED module, whichever is the largest. The flux measurements can also be performed by integration using a goniophotometer. The prescriptions in CIE - Publication 84 - 1989, regarding the room temperature, positioning, etc., shall be taken into consideration.
 - The LED module shall be burned in for approximately one hour in the closed sphere or goniophotometer.
 - The flux shall be measured after stability has occurred, as explained in paragraph 4.3.1.2.

Annex 10**A general illustration for principal passing-beam and beam contributors and correlated light source options**

Figure A10-I
General illustration

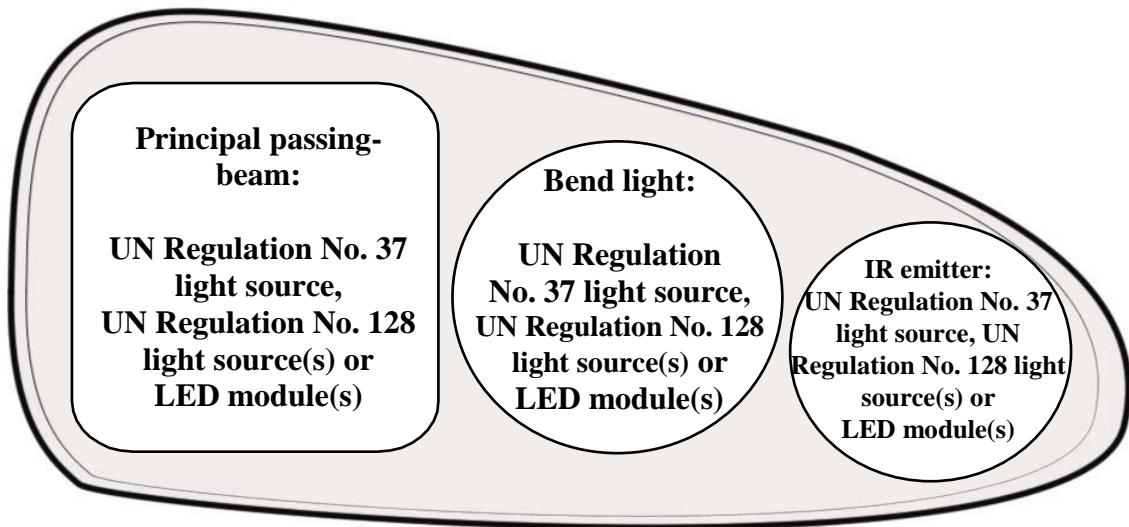

Annex 11

Centre of reference

In the case it is required:

Figure A11-I

Centre of reference

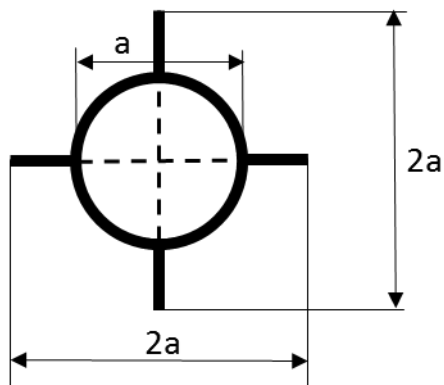

$a = 2 \text{ mm min.}$

This optional mark of the centre of reference shall be positioned on the lens at its intersection with the reference axis of the passing beam and also on the lenses of the driving beams when they are neither grouped nor combined nor reciprocally incorporated with a passing beam and on the lens of a front fog lamp.

Figure A11-I represents the mark of the centre of reference as projected on a plane substantially tangent to the lens about the centre of the circle. The lines constituting this mark may either be solid or dotted.

Annex 12

Voltage markings

Figure A12-I
Voltage marking A

nn V

This marking must be placed on the main body of each headlamp containing only gas discharge light sources and ballast, and on each external part of the ballast.

The ballast(s) is(are) designed for a network system of nn Volts.

Figure A12-II
Voltage marking B

nn $\overline{24}$ V

This marking must be placed on the main body of each headlamp containing at least one gas discharge light source and ballast.

The ballast(s) is(are) designed for a network system of nn Volts.



None of the filament light sources which the headlamp contains is designed for a 24 Volts network system.

Annex 13

Arrangement of approval marks

The following approval mark arrangements are given merely as examples and any other arrangement made in accordance with paragraph 3.3. of this Regulation is acceptable.

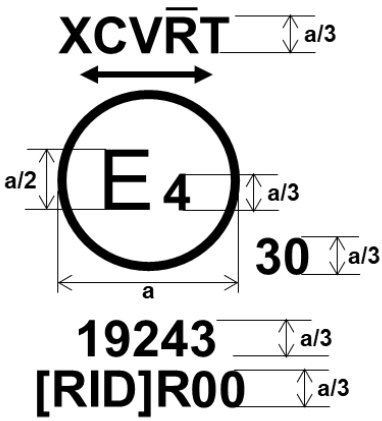
1. Approval mark of a single road illumination device

<p>Figure A13-I - Marking example 1</p>  <p>a = see Par. 3.2.4.3 of this Regulation</p>	<p>The device bearing the approval mark shown on the left is an installation unit of an AFS approved in the Netherlands (E4) under approval number 19243 pursuant to this Regulation.</p> <p>The number after [RID]R indicates that approval was granted in accordance with the requirements of this Regulation in its original form (00).</p> <p>The functions identification symbols show that the approval was granted in respect of the driving-beam (R) and the Class C and Class V passing-beam. The double pointed arrow shows that the passing beam is suitable for both traffic systems by means of an appropriate adjustment of the setting of the optical element or the light source on the vehicle. Class C passing-beam, Class V passing-beam and driving-beam comply to bending lighting provisions, as indicated by the letter "T". The score above the letter "R" indicates that the driving-beam function is provided by more than one installation unit on that side of the system.</p> <p>Number 30 indicates that the maximum luminous intensity of the driving-beam is between 123,625 and 145,125 candelas.</p>
<p>Figure A13-II - Marking example 2</p> 	<p>The lamp bearing the approval mark shown on the left is a gas-discharge passing beam headlamp (DC) for left-hand traffic only (arrow) using a plastic lens (PL) approved in France (E2) pursuant to this Regulation ([RID]R) as set in the original series of amendments (00) combined with a front position lamp (A) as set in the original series of amendments (00) of the Regulation on Light Signalling Devices ([LSD]R). Both lamps (functions) are approved under approval number 3223.</p>

2. Approval mark of grouped, combined or reciprocally incorporated lamps

Note: The vertical and horizontal lines schematize the shape of the light-signalling lamp. These lines are not part of the approval mark.

Figure A13-III
Marking example 3

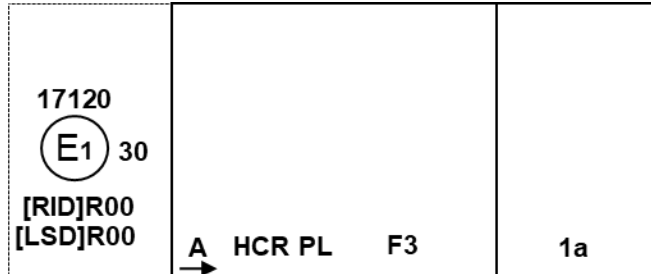
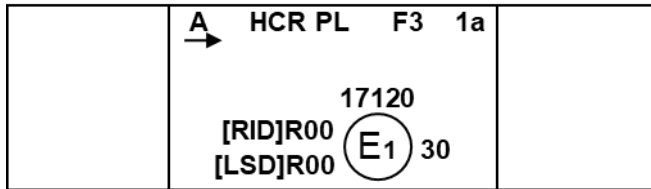

Figure A13-IV
Marking example 4



Note: The examples in Figures A13-III and A13-IV correspond to a lighting device bearing an approval mark comprising:

- (a) A front position lamp approved in accordance with the 00 series of amendments to UN Regulation No. [LSD]. The horizontal arrow indicates the side on which the required photometric specifications are met up to an angle of 80° H;
- (b) A headlamp, Class B, with a passing-beam designed for right-hand traffic only and a driving-beam with a maximum intensity comprised between 123,625 and 145,125 candelas (as indicated by the number 30), approved in accordance with the requirements of this Regulation, as amended by the 00 series of amendments and incorporating a lens of plastic material;
- (c) A front fog lamp approved in accordance with the 00 series of amendments of this Regulation and incorporating a lens of plastic material;
- (d) A front direction indicator lamp of category 1a approved in accordance with the 00 series of amendments to UN Regulation No. [LSD].

3. Identification code of light source modules

Figure A13-V
Light source module marking

MD E3 17325

The light source module bearing the identification code shown in Figure A13-V has been approved together with a lamp approved in Italy (E3) under approval number 17325.

4. Additional lighting units designed to provide bend lighting

Figure A13-VI

Lighting unit marking

ALU E43 1234

The additional lighting unit bearing the identification code shown in Figure A13-VI has been approved together with a headlamp initially approved in Japan (E43) under approval number 1234.

Annex 14

Description forms

Maximum format: A4 (210 x 297 mm)

Adaptive front-lighting system description form No. 1

AFS control signals relevant to the lighting functions, and modes of functions provided by the system

AFS Control Signal	Function/mode(s) of, being influenced by the signal ¹					Technical characteristics ² (use separate sheet, if needed)
	Passing-beam				Driving-beam	
	Class C	Class V	Class E	Class W		
None / default	<input checked="" type="checkbox"/>				<input type="checkbox"/>	
V-Signal	<input type="checkbox"/>	<input type="checkbox"/>	<input type="checkbox"/>	<input type="checkbox"/>	<input type="checkbox"/>	
E-Signal	<input type="checkbox"/>	<input type="checkbox"/>	<input type="checkbox"/>	<input type="checkbox"/>	<input type="checkbox"/>	
W-Signal	<input type="checkbox"/>	<input type="checkbox"/>	<input type="checkbox"/>	<input type="checkbox"/>	<input type="checkbox"/>	
T-Signal	<input type="checkbox"/>	<input type="checkbox"/>	<input type="checkbox"/>	<input type="checkbox"/>	<input type="checkbox"/>	
Other Signals ³	<input type="checkbox"/>	<input type="checkbox"/>	<input type="checkbox"/>	<input type="checkbox"/>	<input type="checkbox"/>	

¹ Mark in the respective box(es) with an cross (X) the combination(s) which apply.

² To be indicated in terms of:

- (a) Physical nature (electrical current/ voltage, optical, mechanical, hydraulic, pneumatic, ...).
- (b) Information type (continuous/analogous, binary, digitally coded,..).
- (c) Time dependent properties (time constant, resolution, ..).
- (d) Signal status when the respective conditions according to paragraph 6.22.7.4. of UN Regulation No. 48 are fulfilled.
- (e) Signal status in case of failure (with reference to the system input).

³ According to the applicants description; use separate sheet, if needed.

Adaptive front-lighting system description form No. 2

Cut-off status, adjustment devices and adjustment procedures relevant to the lighting units

Lighting unit No. ⁴	Cut-off status ⁵		Adjustment device				Characteristics & additional provisions(if any) ⁸
	The lighting unit provides or contributes to one or more passing-beam cut-off(s),		vertical		horizontal		
	as defined in Annex 5 to this Regulation ⁶	and provisions of paragraph 5.3.5.1. of this Regulation apply ⁶	Individual ("master") ^{6,9}	linked to "master" unit No. ⁷	Individual ("master") ^{6,9}	linked to "master" unit No. ⁷	
1	yes / no	yes / no	yes / no	yes / no	
2	yes / no	yes / no	yes / no	yes / no	
3	yes / no	yes / no	yes / no	yes / no	
4	yes / no	yes / no	yes / no	yes / no	
5	yes / no	yes / no	yes / no	yes / no	
6	yes / no	yes / no	yes / no	yes / no	
7	yes / no	yes / no	yes / no	yes / no	

⁴ Designation of each individual lighting unit of the system as indicated in Annex 1 to this Regulation and as shown in the drawing according to paragraph 3.1.2. of this Regulation; use separate sheet(s) if needed.

⁵ Relevant to provisions of paragraph 6.22.6.1.2. of UN Regulation No. 48.

⁶ Strike out what does not apply.

⁷ Indicate corresponding lighting unit(s) number(s), if applicable.

⁸ Information such as e.g.: the order of adjustment of lighting units or assemblies of lighting units, any additional provisions for the adjustment process.

⁹ The adjustment of a "master" lighting unit may also adjust (an) other lighting unit(s).