

## **Draft New Simplified UN Regulation on Light Signalling Devices (LSD).**

**This text is NOT the final version. It is intended to show how the new LSD Regulation will look like with the purpose of collecting constructive comments from GRE.**

**This text includes the introduction of the Unique Identifier (UI) and the amendments adopted by GRE-76.**

### **Agreement**

#### **Concerning the Adoption of Uniform Technical Prescriptions for Wheeled Vehicles, Equipment and Parts which can be Fitted and/or be Used on Wheeled Vehicles and the Conditions for Reciprocal Recognition of Approvals Granted on the Basis of these Prescriptions\***

(Revision 2, including the amendments which entered into force on 16 October 1995)

---

#### **Addendum: XXX: Regulation: LSD**

Date of entry into force as an annex to the Agreement: **Date**

#### **Uniform provisions concerning the approval of light signalling lamps for power-driven vehicles and their trailers**



UNITED NATIONS

---

\* Former title of the Agreement: Agreement Concerning the Adoption of Uniform Conditions of Approval and Reciprocal Recognition of Approval for Motor Vehicle Equipment and Parts, done at Geneva on 20 March 1958.



## Regulation No. **LSD**

### Uniform provisions concerning the approval of light-signalling lamps for power-driven vehicles and their trailers

#### Contents

	<i>Page</i>
Regulation	
1. Scope .....	4
2. Definitions.....	5
3. Administrative Provisions .....	5
4. General Technical Requirements .....	14
5. Specific Technical Requirements .....	21
6. Transitional Provisions.....	30
Annexes	
1 Communication .....	31
2 Light distribution in space, horizontal and vertical .....	35
3 Standard light distributions .....	37
4 Minimum requirements for conformity of production control procedures.....	46
5 Minimum requirements for sampling by an inspector.....	49
6 Heat resistance test for rear fog lamps and daytime running lamps .....	51
7 Arrangement of Approval Marks .....	52

## Introduction

This regulation is the outcome of the decision to simplify the UN lighting and light-signalling regulations by combining the provisions of the individual UN Regulations 4,6,7,23,38,50,77,87 and 91 into a single regulation. The objective was to reduce the number of regulations through an editorial exercise without changing any of the detailed technical requirements already in force up to the date of entry into force of this regulation.

Although this regulation departs from the traditional approach of having a separate regulation for each lamp, by combining all light signalling lamps into a single regulation, this simplified regulation will contain all provisions and operate according to the existing structure of series of amendments, their transitional provisions and supplements. The transitional provisions associated with a new series of amendments of the regulations will be identified for each class of the lamp as applicable. The section of the Regulation concerning the transitional provisions also includes a list of lamps and their applicable series of amendments.

It is expected that all contracting parties to the 1958 agreement will adopt this regulation but they still have the freedom to choose to adopt, or not to adopt, particular lamps. These decisions will be registered in ECE/TRANS/WP.29/343 that records the status of the annexed Regulations and of the amendments).

Regarding the requirements for approval markings, this regulation includes the requirements for conventional markings and also allows, at the request of the applicant and if the UN secure internet database is operative, the use of the "Unique Identifier". When the "Unique Identifier" is used there is no requirement for the lamps to carry the traditional type approval markings. These markings are replaced by access to the UN secure internet database (in accordance with Schedule 5 of the 1958 Agreement) where all type approval documentation is held.

## 1. Scope

This Regulation applies to the following lamps:

- Rear-registration plate illuminating devices
- Direction indicator lamps
- Front position lamps
- Rear position lamps
- Stop lamps
- End outline marker lamps
- Reversing lamps
- Manoeuvring lamps
- Rear fog lamps
- Parking lamps
- Daytime running lamps
- Side marker lamps

## 2. Definitions

For the purposes of this Regulation:

- 2.1 All the definitions given in UN Regulation No. 48 and its series of amendments in force at the time of application for type approval shall apply, except:
- 2.1.1 "*Lamp*" means light-signalling devices except retro-reflecting devices and marking plates/devices/materials.
- 2.1.2. "*Lamps of different type*" means lamps, which differ in such essential respects as:
- a) the trade name or mark:
    - (i) lamps bearing the same trade name or mark but produced by different manufacturers are considered as being of different types;
    - (ii) lamps produced by the same manufacturer differing only by the trade name or mark are considered as being of the same type.
  - b) the characteristics of the optical system (levels of intensity, light distribution angles, , inclusion or elimination of components capable of altering the optical effects by reflection, refraction, absorption and/or deformation during operation, etc.).
  - c) the category or categories of light source(s) used and/or the specific identification code (s) of the light source module(s).
  - d) the category of the lamp, if any;
  - e) the variable intensity control, if any;
  - f) the sequential activation of light sources, if any.
- Nevertheless, direction indicators capable of being activated in different modes (sequential or not) without any modification of the optical characteristics of the lamp do not constitute "Direction indicators of different types
- A change of the colour of the light source or the colour of any filter does not constitute a change of type.
- 2.1.3 "Rear registration plate lamp" means the device which illuminates the rear registration plate by reflection. For the approval of this lamp, the illumination of the space to be occupied by the plate is determined.

### **3. Administrative Provisions**

- 3.1. APPLICATION FOR APPROVAL
- 3.1.1 The application for type approval shall be submitted by the holder of the trade name or mark or by his duly accredited representative.
- 3.1.2 It shall be accompanied by:
- 3.1.2.1 drawings, sufficiently detailed to permit identification of the type and, if applicable, of the category of the lamp, showing:
- a) geometrically in what position(s) the lamp (and if applicable for category S3 or S4 lamps the rear window) may be mounted on the vehicle;

- b) the axis of observation to be taken as the axis of reference in the tests (horizontal angle  $H = 0^\circ$ , vertical angle  $V = 0^\circ$ ); and the point to be taken as the centre of reference during the tests;
  - c) the limit of the apparent surface of the function(s);
  - d) The position intended for the “Unique Identifier”.
  - e) in case of LED module(s) also the space reserved for the specific identification code(s) of the module(s);
  - f) in the case of an interdependent lamp system, the interdependent lamp or the combination of interdependent lamps;
- 3.1.2.2. a brief technical description stating in particular, with the exception of lamps with non-replaceable light sources:
- a) the category or categories of filament light source(s) prescribed; this filament light source category shall be one of those contained in UN Regulation No. 37;
  - b) the category or categories of LED light source(s) prescribed; this LED light source category shall be one of those contained in UN Regulation No. 128;
  - c) the light source module specific identification code;
- 3.1.2.3. However, in the case of a type of lamp differing only by the trade name or mark from a type that has already been approved it is sufficient that the application is accompanied by:
- 3.1.2.3.1. a declaration by the lamp manufacturer that the type submitted is identical (except in the trade name or mark) with and has been produced by the same manufacturer as the type already approved, the latter being identified by its approval code;
- 3.1.2.3.2. two samples bearing the new trade name or mark or equivalent documentation.
- 3.1.2.4. in the case of a lamp with variable intensity, a concise description of the variable intensity control. For a double-intensity lamp, an arrangement diagram and a specification of the characteristics of the system ensuring the two levels of intensity;
- 3.1.2.5. if applicable in the case of a non-replaceable filament light source(s) or light source module(s) equipped with non-replaceable filament light source(s), the documents according to paragraph 3.3.5.4. of this UN Regulation;
- 3.1.2.6. at the discretion of the applicant, the description may specify if the lamp may be installed on the vehicle with different inclinations of the reference axis in respect to the vehicle reference planes and to the ground, or rotate around its reference axis; these different conditions of installation shall be indicated in the communication form.
- 3.1.2.7. If not otherwise specified for the relevant lamp, the following samples:
- a) two complete samples of the lamp.
- If application is made for the approval of lamps which are not identical but are symmetrical and suitable for mounting one on the left and one on the right side of the vehicle, the two samples submitted

may be identical and be suitable for mounting only on the right or only on the left side of the vehicle.

- b) for a variable-intensity lamp, a sample of the variable intensity control or a generator providing the same signal(s).

3.1.2.8. In the case of a category S3 or S4 stop lamp which is intended to be mounted inside the vehicle, a sample plate or sample plates (in case of different possibilities) having the equivalent optical properties corresponding to those of the actual rear window(s).

## 3.2. APPROVAL

3.2.1 A separate approval is required for each lamp listed in paragraph 1

3.2.2 When two or more lamps are part of the same unit of grouped, combined or reciprocally incorporated lamps, approval may be granted only if each of these lamps satisfy the provisions set out in this Regulation or in another Regulation. Lamps not satisfying the provisions of any of those Regulations shall not be part of such unit of grouped, combined or reciprocally incorporated lamps.

3.2.3. If the type of lamp(s) submitted for approval in pursuance of paragraph 3.1. meet the requirements of this Regulation:

3.2.3.1. approval shall be granted;

3.2.3.2. notice of approval or of extension or refusal or withdrawal of approval or production definitely discontinued of a type of a lamp pursuant to this UN Regulation shall be communicated to the Contracting Parties to the 1958 Agreement which apply this UN Regulation, by means of a form conforming to the model in Annex 1;

3.2.3.3. An approval number shall be assigned to each type approved and shall be indicated on the "Communication concerning approval" provided in Annex 1.

A contracting party may assign the same approval number to light-signalling lamps or systems incorporating a number of lamps but shall not assign the same number to another type of lamp of the same function.”

3.2.3.4. The identification symbols to be referenced in the paragraph 9.1. of Annex 1 shall be as follows:

Light Signalling Function	Symbol	Paragraph
Daytime running lamp	RL	5-4
Front direction indicator lamp to be installed between 40 mm and 20 mm from dipped beam headlamp or front fog lamp	1a	5-6
Front direction indicator lamp to be installed less than 20 mm from dipped beam headlamp or front fog lamp	1b	5-6
Front direction indicator lamp to be installed more than 40 mm from dipped beam headlamp or front fog lamp	1	5-6
Front direction indicator lamp to be installed on vehicles of category L	11	5-6
Front end-outline marker lamp	AM	5.1

Front position (Motorcycle)	AM	5.1
Front position lamp	A	5.1
Manoeuvring lamp	ML	5-10
Parking lamp (Forward and rearward facing)	77R	5-3
Rear direction indicator lamp (steady luminous intensity)	2a	5-6
Rear direction indicator lamp (variable luminous intensity)	2b	5-6
Rear direction indicator lamp to be installed on vehicles of category L	12	5-6
Rear end-outline marker lamp (steady luminous intensity)	RM1	5-2
Rear end-outline marker lamp (variable luminous intensity)	RM2	5-2
Rear fog lamp (steady luminous intensity)	F1	5-9
Rear fog lamp (variable luminous intensity)	F2	5-9
Rear position (Motorcycle)	MR	5.2
Rear position lamp (steady luminous intensity)	R1	5-2
Rear position lamp (variable luminous intensity)	R2	5-2
Rear registration plate illuminating device: Illuminated area for use on a vehicle mounted a registration plate, the size of which is 340 x 240 mm or less (tall plate).	L-1a	5-11
Rear registration plate illuminating device: Illuminated area for use on a vehicle mounted a registration plate, the size of which is 520 x 120 mm or less (wide plate).	L-1b	5-11
Rear registration plate illuminating device: Illuminated area for use on a vehicle mounted a registration plate, the size of which is 255 x 165 mm or less (plate for agricultural or forestry tractors).	L-1c	5-11
Rear registration plate illuminating device: Illuminated area for use on a vehicle mounted a registration plate, the size of which is 330 x 165 mm or less.	L-2a	5-11
Rear registration plate illuminating device: Illuminated area for use on a vehicle mounted a registration plate, the size of which is 440 x 220 mm or less.	L-2b	5-11
Reversing lamp	AR	5-8
Side direction indicator lamp for vehicles M1 and vehicles N1, M2 and M3 up to 6000 mm in length	5	5-6
Side direction indicator lamp for vehicles N2 and N3 and vehicles N1, M2 and M3 more than 6000 mm in length	6	5-6
Side marker lamp for all vehicle categories	SM1	5-7
Side marker lamp for M1 vehicles	SM2	5-7
Stop lamp (central high mounted) (steady luminous intensity)	S3	5-5



Stop lamp (central high mounted) (variable luminous intensity)	S4	5-5
Stop lamp (Motorcycle)	MS	5-5
Stop lamp (steady luminous intensity)	S1	5-5
Stop lamp (variable luminous intensity)	S2	5-5

### 3.3 APPROVAL MARK

#### 3.3.1. General provisions

3.3.1.1. Every lamp belonging to an approved type shall comprise the international approval mark or, at the request of the applicant, the Unique Identifier (UI) mark as referred to in Schedule 5 of the 1958 Agreement.

3.3.1.2. Examples of the arrangement of the markings are shown in Annex 7.

3.3.2. The International approval mark shall consist of:

3.3.2.1. A circle surrounding the letter "E" followed by the distinguishing number of the country which has granted approval.

3.3.2.2. The approval number prescribed in paragraph 3.2.1.3.

3.3.2.2.1. For parking lamps in addition, the number of this Regulation followed by the letter "R", a dash and the approval number;

3.3.2.3. The symbols identifying the light signalling lamps prescribed in paragraphs 3.2.1.5.

3.3.2.4. The two digits of the approval number which indicate the series of amendments in force at the time of issue of the approval.

3.3.2.4.1. The two digits indicating the series of amendments in force are:

Lamp	Series of amendments
Daytime running lamp	00
Front direction indicator lamp	00
Front direction indicator lamp (Motorcycle)	00
Front end-outline marker lamp	00
Front position (Motorcycle)	00
Front position lamp	00
Manoeuvring lamp	00
Parking lamp	00
Rear direction indicator lamp	00
Rear direction indicator lamp (Motorcycle)	00
Rear end-outline marker lamp	00
Rear fog lamp	00
Rear position (Motorcycle)	00
Rear position lamp	00
Rear registration plate illuminating device	00
Rear-registration plate illuminating device	00
Reversing lamp	00
Side direction indicator lamp	00

Side marker lamp	00
Stop lamp	00
Stop lamp (central high mounted)	00
Stop lamp (Motorcycle)	00

- 3.3.2.5. The following additional symbol (or symbols):
- 3.3.2.5.1. On lamps which cannot be mounted on either side of the vehicle indiscriminately, a horizontal arrow showing in which position the lamp is to be mounted.
- 3.3.2.5.1.1. the arrow shall be directed outwards from the vehicle in the case of:
- direction indicators categories 1, 1a, 1b, 2a and 2b.
  - front or rear position lamps
  - reversing lamps
- 3.3.2.5.1.2. towards the front of the vehicle in the case of direction indicators of categories 3, 4, 5 and 6.
- 3.3.2.5.1.3. For direction indicators of category 6 an indication "R" or "L" shall in this case be shown on the lamp, indicating the right or left side of the vehicle.
- 3.3.2.5.2. If applicable, to the right side of the symbol mentioned in paragraph 3.2.1.5.:
- (a) The additional letter "D", on lamps which may be used as part of an assembly of two lamps.
- (b) The additional letter "Y", on lamps which may be used as part of an interdependent lamps system.
- 3.3.2.5.3. On lamps with reduced light distribution, see paragraph 4.7.5.1., a vertical arrow starting from a horizontal segment and directed downwards.
- 3.3.2.5.4. The approval mark and the additional symbols shall be placed close to the circle prescribed in paragraph 3.3.2.1. and either above or below the letter "E", or to the right or left of that letter. The digits of the approval number shall be on the same side of the letter "E" and face the same direction. The use of Roman numerals as approval numbers should be avoided so as to prevent any confusion with other symbols.
- 3.3.3. The Unique Identifier mark shall follow the format in the example shown below:

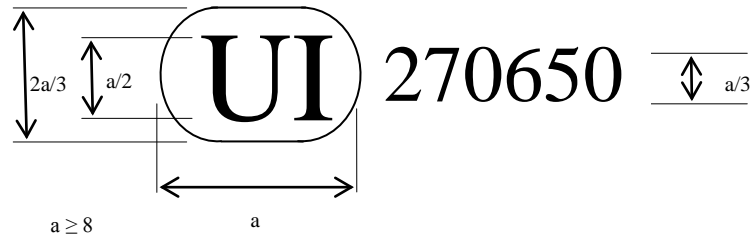

The above Unique Identifier marked on the lamp shows that the type concerned has been approved and that the relevant information on that type approval can be accessed on the UN secure internet database by using 270650 as the Unique Identifier.

#### 3.3.4. MARKING REQUIREMENTS

Lamps submitted for approval shall:

- 3.3.4.1. Comprise a space of sufficient size for the approval marking and the additional symbols as prescribed in paragraph 3.3.2. or the Unique Identifier as prescribed in paragraph 3.3.3.; this space shall be shown in the drawings mentioned in paragraph 3.1.2.1.
  - 3.3.4.1.1. In any case the approval mark and the additional symbols or the Unique Identifier shall be visible when the lamp is fitted on the vehicle or when a movable part such as the hood or boot lid or a door is opened.
  - 3.3.4.1.2. The approval mark and the additional symbols shall be placed on an inner or outer part (transparent or not) of the lamp which cannot be separated from the transparent part of the lamp emitting the light.
- 3.3.4.2. Bear the trade name or mark of the applicant; this marking shall be clearly legible and indelible;
- 3.3.4.3. With the exception of lamps with non-replaceable light sources, bear a clearly legible and indelible marking indicating:
  - (a) The category or categories of light source(s) prescribed; and/or
  - (b) The light source module specific identification code
- 3.3.4.4. In the case of lamps with:
  - (a) an electronic light source control gear; or
  - (b) a variable luminous intensity control; and/or
  - (c) a secondary operating mode; and/or
  - (d) non-replaceable light sources; and/or
  - (e) light source module(s);bear marking of the rated voltage or the range of voltage;
- 3.3.4.5. In the case of lamps with light source module(s) on the light source module(s) marking of:
  - (a) the trade name or mark of the applicant;
  - (b) the specific identification code of the module;. This specific identification code shall comprise the starting letters "MD" for

“MODULE” followed by the approval mark without the circle as prescribed in paragraph 3.3.2. or by the UI without the truncated circle as prescribed in paragraph 3.3.3 The approval mark or the UI does not have to be the same as the one on the lamp in which the module is used, but both marks shall be from the same applicant;

(c) the rated voltage or the range of voltage.

3.3.4.6. On the electronic light source control gear or a variable luminous intensity control being part of the lamp but not included into the lamp body, marking of the name of the manufacturer and its identification number.

3.3.4.7. The markings in paragraphs 3.3.4.2. to 3.3.4.6. shall be affixed in an indelible and clearly legible manner on the lamp but do not need to fulfil the requirements of paragraph 3.3.4.1.

3.3.5. **GROUPED, COMBINED OR RECIPROCALLY INCORPORATED LAMPS**

3.3.5.1. Where grouped, combined or reciprocally incorporated lamps have been found to comply with the requirements of several Regulations, a single international approval mark may be affixed, consisting of a circle surrounding the letter "E" followed by the distinguishing number of the country which has granted the approval, and an approval number. This approval mark may be located anywhere on the grouped, combined or reciprocally incorporated lamps, provided that:

3.3.5.1.1. It is visible after their installation;

3.3.5.1.2. No part of the grouped, combined or reciprocally incorporated lamps that transmits light can be removed without at the same time removing the approval mark.

3.3.5.2. The identification symbol for each lamp together with the corresponding series of amendments incorporating the most recent major technical amendments to the Regulation at the time of issue of the approval and, if necessary, the required additional symbols shall be marked:

3.3.5.2.1. Either on the appropriate light-emitting surface,

3.3.5.2.2. Or in a group, in such a way that each of the grouped, combined or reciprocally incorporated lamps may be clearly identified.

3.3.5.3. The size of the components of a single approval mark shall not be less than the minimum size required for the smallest of the individual marks under which approval has been granted.

3.3.5.4. Annex 7 to this Regulation gives examples of approval marks for grouped, combined or reciprocally incorporated lamps with all the above mentioned additional symbols.

3.4 MODIFICATIONS OF A TYPE OF LAMP FOR MOTOR VEHICLES AND THEIR TRAILERS AND EXTENSION OF APPROVAL

3.4.1. Every modification of a type of lamp shall be notified to the Type Approval Authority which approved the type. The Authority may then either:

3.4.1.1. Consider that the modifications made are unlikely to have an appreciable adverse effect and that in any case the lamp still complies with the requirements; or

3.4.1.2. Require a further test report from the technical service responsible for conducting the tests.

3.4.2. Confirmation or refusal of approval, specifying the alterations, shall be communicated by the procedure specified in paragraph 3.2.1.4. to the Contracting Parties to the 1958 Agreement applying this UN Regulation.

3.4.3. The Type Approval Authority issuing the extension of approval shall assign a series number for such an extension and inform thereof the other Contracting Parties to the 1958 Agreement applying the UN Regulation under which the approval has been granted by means of a communication form conforming to the model in Annex 1 to this UN Regulation.

3.5. CONFORMITY OF PRODUCTION

The conformity of production procedures shall comply with those set out in the Agreement, Appendix 2 (E/ECE/324-E/ECE/TRANS/505/Rev.2), with the following requirements:

3.5.1. Lamps shall be so manufactured as to conform to the type approved under this regulation. The compliance with the requirements set forth in paragraphs 4 and 5 shall be verified as follows:

3.5.1.1. The minimum requirements for conformity of production control procedures set forth in Annex 4 shall be complied with;

3.5.1.2. The minimum requirements for sampling by an inspector set forth in Annex 5 shall be complied with;

3.5.2. The authority which has granted type approval may at any time verify the conformity control methods applied in each production facility. The normal frequency of these verifications shall be once every two years.

The Contracting Parties to the 1958 Agreement to which this UN Regulation is annexed are not precluded by Article 3 of that Agreement from prohibiting, for lamps installed on vehicles registered by them, certain colours for which provision is made in this Regulation, or from prohibiting for all categories or for certain categories of vehicles registered by them stop-lamps having only steady luminous intensity.

3.5.3. In the case of non-replaceable filament light source(s) or light source module(s) equipped with non-replaceable filament light source(s), the applicant shall annex to the type approval documentation a report, acceptable to the Authority responsible for type approval that demonstrates compliance of these non-replaceable filament light source with the requirements as specified in paragraph 4.11 of IEC 60809, Edition 3.

3.6. PENALTIES FOR NON-CONFORMITY OF PRODUCTION

- 3.6.1 The approval granted may be withdrawn if the requirements in this UN Regulation are not met;
- 3.6.2 If a Contracting Party to the 1958 Agreement which applies this UN Regulation withdraws an approval it has previously granted, it shall forthwith so notify the other Contracting Parties applying this UN Regulation, by means of a communication form conforming to the model in Annex 1.
- 3.7 **PRODUCTION DEFINITELY DISCONTINUED**
- If the holder of the approval completely ceases to manufacture a lamp approved in accordance with this UN Regulation, he shall so inform the authority which granted the approval. Upon receiving the relevant communication, that authority shall inform thereof the other Contracting Parties to the 1958 Agreement applying this UN Regulation by means of a communication form conforming to the model in Annex 1.
- 3.8. **NAMES AND ADDRESSES OF TECHNICAL SERVICES RESPONSIBLE FOR CONDUCTING APPROVAL TESTS, AND OF ADMINISTRATIVE DEPARTMENTS**
- The Contracting Parties to the 1958 Agreement which apply a Regulation shall communicate to the United Nations Secretariat the names and addresses of the Technical Services responsible for conducting approval tests and of the Administrative Departments which grant approval and to which forms certifying approval or extension or refusal or withdrawal of approval, or the definitive discontinuation of production issued in other countries, are to be sent.

## **4. General Technical Requirements**

Each lamp submitted for approval shall conform to the requirements set forth in paragraphs 4 and 5.

- 4.1 The requirements contained in sections 4 "General technical requirements" and 5 "Specific technical requirements" and in the Annexes referenced in the said sections of UN Regulations Nos. 48, 53, 74 or 86, and their series of amendments in force at the time of application for the lamp type approval shall apply to this UN Regulation.
- The requirements pertinent to each lamp and to the category/ies of vehicle on which the lamp is intended to be installed shall be applied, where its verification at the moment of lamp type approval is feasible.
- 4.2 The lamps must be so designed and constructed that in normal conditions of use, and notwithstanding the vibrations to which they may be subjected in such use, their satisfactory operation remains assured and they retain the characteristics prescribed by this UN Regulation.
- 4.3 Light sources:
- 4.3.1 In the case of replaceable light source(s):

- 4.3.1.1 Any category or categories of light source(s) approved according to UN Regulation No. 37 and/or UN Regulation No. 128 may be used, provided that no restriction on the use is made in UN Regulation No. 37 and its series of amendments in force at the time of application for type approval or in UN Regulation No. 128 and its series of amendments in force at the time of application for type approval.
- 4.3.1.2. In the case of a light source category or categories or type(s) is restricted for use in lamps on vehicles in use and originally equipped with such lamps, the applicant for type approval of the lamp shall declare that the lamp is only intended for installation on those vehicles; this shall be noted in the communication form.
- 4.3.1.3. The design of the lamp shall be such that the light source(s) can be fixed in no other position but the correct one.
- 4.3.1.4. The light source(s) holder shall conform to the characteristics given in IEC Publication 60061. The holder data sheet relevant to the category of light source(s) used, applies.
- 4.3.2 In the case of light source modules, it shall be checked that:
- 4.3.2.1 The design of the light source module(s) shall be such as:
- (a) That each light source module can only be fitted in no other position than the designated and correct one and can only be removed with the use of tool(s);
  - (b) If there are more than one light source module used in the housing for a lamp, light source modules having different characteristics can not be interchanged within the same lamp housing.
- 4.3.2.2. The light source module(s) shall be tamperproof.
- 4.3.2.3. A light source module shall be so designed that regardless of the use of tool(s), it shall not be mechanically interchangeable with any replaceable approved light source.
- 4.3.2.4. In the case of non-replaceable filament light source(s) or light source module(s) equipped with non-replaceable filament light source(s), the applicant shall annex to the type approval documentation a report, acceptable to the Authority responsible for type approval, that demonstrates compliance of these non-replaceable filament light source(s) with the requirements as specified in paragraph 4.11 of IEC 60809, Edition 3.
- 4.4. INDEPENDENT AND INTERDEPENDENT LAMPS
- 4.4.1. An assembly of two independent lamps to be type approved as lamp marked "D" is applicable to front and rear position lamps, stop lamps, and direction indicator lamps of categories 1, 1a, 1b, 2a, 2b;
- 4.4.2. An interdependent lamp system is applicable to front and rear position lamps, daytime running lamps and direction indicator lamps of categories 2a, 2b.
- 4.5. LAMPS AS SUCH OR GROUPED, COMBINED, RECIPROCALLY INCORPORATED:
- 4.5.1. Lamps having been approved as front or rear position lamps, are deemed being also approved end-outline marker lamps.

- 4.5.2. Front and rear position lamps which are grouped or combined or reciprocally incorporated may also be used as end-outline marker lamps.
- 4.5.3. Position lamps or daytime running lamps, which are reciprocally incorporated with another function, using a common light source, and designed to operate permanently with an additional system to regulate the intensity of the light emitted, are permitted.
- 4.5.4. However, in the case of rear position lamp reciprocally incorporated with a stop lamp, the lamp shall either:
- (a) Be a part of a multiple light source arrangement, or
  - (b) Be intended for use in a vehicle equipped with a failure monitoring system for that function.
- In either case, a note shall be made within the communication document.
- 4.5.5. If the front position lamp incorporates one or more infrared radiation generators, the photometric and colour requirements for this front position lamp shall be met with and without the operation of the infrared radiation generator(s).
- 4.6. FAILURE PROVISIONS
- 4.6.1. Failure of a single lamp containing more than one light source
- 4.6.1.1. In a single lamp containing more than one light source, a group of light sources, wired so that the failure of any one of them causes all of them to stop emitting light, shall be considered to be one light source.
- 4.6.1.2. In case of failure of any one light source in a single lamp containing more than one light source, at least one of the following provisions shall apply:
- (a) The light intensity complies with the minimum intensity required in the table of standard light distribution in space as shown in Annex 3, or



- (b) A signal for activation of a tell-tale indicating failure, as indicated in paragraphs 6.7.8., 6.9.8, 6.10.8. and 6.13.8. of Regulation No. 48, is produced, provided that the luminous intensity in the axis of reference is at least 50 per cent of the minimum intensity required. In this case a note in the communication form states that the lamp is only for use on a vehicle fitted with a tell-tale indicating failure

These requirements do not apply to Daytime Running Lamps that shall comply with the requirements of paragraph 5.4.5.

4.6.2. In case of failure of the variable intensity control of:

- (a) A rear position lamp category R2 emitting more than the maximum value of category R or R1;
- (b) A rear end-outline marker lamp category RM2 emitting more than the maximum value of category RM1;
- (c) A stop lamp category S2 emitting more than the maximum value of category S1;
- (d) A stop lamp category S4 emitting more than the maximum value of category S3;
- (e) A direction indicator of category 2b emitting more than the maximum value of category 2a,

Requirements of steady luminous intensity of the respective category shall be fulfilled automatically.

4.7. TEST CONDITIONS

4.7.1. All measurements, photometric and colorimetric, shall be made:

4.7.1.1. In case of a lamp with replaceable light source, if not supplied by an electronic light source control gear or a variable intensity control, with an uncoloured or coloured standard filament light source of the category prescribed for the lamp, supplied with the voltage necessary to produce the reference luminous flux required for that category of filament light source,

4.7.1.2. In the case of a light source, which is operated independently from vehicle supply voltage and fully controlled by the system, or in the case of a light source supplied by a special power supply, the test voltage as specified by the applicant shall be applied to the input terminals of the light source or 6.75 V, 13.5 V or 28.0 V shall be applied to the input terminals of that system/power supply. The test laboratory may require from the manufacturer this special power supply needed to supply the light sources.

4.7.1.3. In the case of a lamp equipped with non-replaceable light sources (filament light sources and other), with the light sources present in the lamp.

4.7.1.3.1. If operating directly under vehicle voltage system conditions:

All measurements on lamps equipped with non-replaceable light sources shall be made at 6.75 V, 13.5 V or 28.0 V, or at a voltage as specified by the applicant with respect to any other vehicle voltage system.

- 4.7.1.3.2. If operated independently from vehicle supply voltage and fully controlled by the system, or in the case of a light source supplied by a special power supply, the test voltage as specified in paragraph 3.7.1.3.1. of this UN Regulation shall be applied to the input terminals of that system/power supply. The test laboratory may require from the manufacturer this special power supply needed to supply the light sources.
- 4.7.1.4. In the case of a system that uses an electronic light source control gear or a variable intensity control, being part of the lamp applying at the input terminals of the lamp the voltage declared by the manufacturer or, if not indicated, 6.75 V, 13.5 V or 28.0 V respectively.
- 4.7.1.5. In the case of a system that uses an electronic light source control gear or a variable intensity control, not being part of the lamp the voltage declared by the manufacturer shall be applied to the input terminals of the lamp.
- 4.7.2. However, in the case of light sources operated by a variable intensity control to obtain variable luminous intensity, photometric measurements shall be performed according to the applicant's description.
- 4.7.3. The test laboratory shall require from the manufacturer the light source control gear or a variable intensity control needed to supply the light source and the applicable functions.
- 4.7.4. The voltage to be applied to the lamp shall be noted in the communication form in Annex 1 to this UN Regulation.
- 4.7.5. The limits of the apparent surface in the direction of the reference axis of a light-signalling lamp shall be determined.
- 4.7.5.1. However, in the case where a lamp is intended to be installed at a mounting height (reference axis specified by the manufacturer) of equal to or less than 750 mm above the ground, the photometric intensity is verified only up to an angle of 5° downwards.
- 4.7.6. In the case of a category S3 or S4 stop lamp, which is intended to be mounted inside the vehicle a sample plate or sample plates (in case of different possibilities) as supplied (see paragraph 2.1.4.6. of this UN Regulation) shall be positioned in front of the lamp to be tested, in the geometrical position(s) as described in the application drawing(s) (see paragraph 2.1.3.1. of this UN Regulation).
- 4.8 PHOTOMETRIC MEASUREMENTS
- 4.8.1. Measurement provisions
- 4.8.1.1. During photometric measurements, stray reflections shall be avoided by appropriate masking.
- 4.8.1.2. In case the results of measurements should be challenged, measurements shall be carried out in such a way as to meet the following requirements:
- 4.8.1.2.1. The distance of measurement shall be such that the law of the inverse of the square of the distance is applicable;
- 4.8.1.2.2. The measuring equipment shall be such that the angular aperture of the receiver viewed from the reference centre of the light is comprised between 10' and 1 degree;

- 4.8.1.2.3. The intensity requirement for a particular direction of observation shall be deemed to be satisfied if that requirement is met in a direction deviating by not more than one-quarter of a degree from the direction of observation.
- 4.8.1.3. In the case where the lamp may be installed on the vehicle in more than one or in a field of different positions the photometric measurements shall be repeated for each position or for the extreme positions of the field of the reference axis specified by the manufacturer.
- 4.8.2. Measurement methods
- 4.8.2.1. The photometric performance shall be checked in accordance with the relevant sub-paragraph of paragraph 3.7.
- 4.8.2.2. For multiple replaceable light sources:
- When equipped with light source(s) at 6.75 V, 13.5 V or 28.0 V, the luminous intensity values produced shall be corrected. For these replaceable filament light sources the correction factor is the ratio between the reference luminous flux and the mean value of the luminous flux found at the voltage applied (6.75 V, 13.5 V or 28.0 V).
- For LED light sources the correction factor is the ratio between the objective luminous flux and the mean value of the luminous flux found at the voltage applied (6.75 V, 13.5 V or 28.0 V).
- The actual luminous fluxes of light source used shall not deviate more than 5 per cent from the mean value. Alternatively and in case of filament light sources only, a standard filament light source may be used in turn, in each of the individual positions, operated at its reference flux, the individual measurements in each position being added together.
- 4.8.2.3. Each signalling lamp shall conform to the intensities of light emitted outside the reference axis and within the angular fields defined in the diagrams in Annex 2 to this Regulation, the intensity of the light emitted by each of the two lamps supplied shall:
- 4.8.2.3.1. In each direction corresponding to the points in the light distribution table reproduced in Annex 3 to this Regulation, be not less than the product of the minimum specified in the table of each function below, by the percentage specified in the said table of the direction in question;
- 4.8.2.3.2. In no direction within the space from which the light-signalling lamp is visible, exceed the maximum specified in the table of each function below;
- 4.8.3. When an assembly of two independent lamps, to be type approved as lamps marked "D" and having the same function, is deemed to be a single lamp, it shall comply with the requirements for:
- (a) Maximum intensity if all lamps together are lit;
- (b) Minimum intensity if either lamp has failed.
- 4.8.4. Interdependent lamp system:
- An interdependent lamp system shall meet the requirements when all its interdependent lamps are operated together. However if the interdependent lamp system, providing one of the lamp functions listed in paragraph 3.2.1.5. is partly mounted on the fixed component and partly mounted on a movable component, the interdependent lamp(s) specified by the Applicant shall meet

the outboard geometric visibility, colorimetric and photometric requirement, at all fixed positions of the movable component(s). In this case, the inboard geometric visibility requirement is deemed to be satisfied if this (these) interdependent lamp(s) still conform to the photometric values prescribed in the field of light distribution for the approval of the lamp, at all fixed positions of the moveable component(s).

- 4.8.5 The provisions of the relevant paragraphs of Annex 3 to this UN Regulation on local variations of intensity must be observed.
- 4.8.6 If not otherwise specified, the intensities shall be measured with the light source continuously alight and, in the case of lamps emitting red light, in coloured light.
- 4.8.7 In the case of lamps of categories R2, RM2, S2, S4 and 2b, the time that elapses between energising the light source(s) and the light output measured on the reference axis to reach 90 per cent of the value measured in accordance with paragraph 5 shall be measured for the extreme levels of luminous intensity produced by the lamp. The time measured to obtain the lowest luminous intensity shall not exceed the time measured to obtain the highest luminous intensity.
- 4.8.8 The variable intensity control shall not generate signals which cause luminous intensities:
- 4.8.8.1 Outside the range specified in paragraph 5 and
- 4.8.8.2 Exceeding the respective steady luminous intensity maximum specified in paragraph 5 below for the specific lamp:
- (a) For systems depending only on daytime and night time conditions: under night time conditions;
- (b) For other systems: under standard conditions<sup>1</sup>.
- 4.8.9 Particulars of the methods of measurement to be used are given in Annex 3.
- 4.8.10 If a rear position lamp is reciprocally incorporated with a stop-lamp producing either steady or variable luminous intensity, the ratio between the luminous intensities actually measured of the two lamps when turned on simultaneously at the intensity of the rear position lamp when turned on alone should be at least 5: 1 in the field delimited by the straight horizontal lines passing through  $\pm 5^\circ$  V and the straight vertical lines passing through  $\pm 10^\circ$  H of the light distribution table.
- 4.9 COLOUR OF LIGHT EMITTED

The colour of the light emitted shall be measured inside the field of the light distribution grid defined for the specific function in the relevant paragraph of Annex 3. To check these colorimetric characteristics the test procedure described in paragraph 4.7. shall be applied. Outside this field no sharp variation of colour shall be observed.

---

<sup>1</sup> Good visibility (meteorological optical range MOR > 2,000 m defined according to WMO, Guide to Meteorological Instruments and Methods of Observation, Sixth Edition, ISBN: 92-63-16008-2, pp 1.9.1/1.9.11, Geneva 1996 ) and clean lens.

However, for lamps equipped with non-replaceable light sources, the colorimetric characteristics should be verified with the light sources present in the lamp, in accordance with relevant subparagraphs of paragraph 4.7. of this Regulation.

## 5. Specific Technical Requirements

### 5.1 TECHNICAL REQUIREMENTS CONCERNING FRONT POSITION LAMPS, (SYMBOLS A,) AND FRONT END-OUTLINE MARKER LAMPS, (SYMBOLS AM)

5.1.1. The light emitted by each of the two lamps supplied shall be not less than the minimum intensity in the reference axis as indicated in the table below and not more than the maximum luminous intensity in any direction the lamp is visible as indicated in the table below:

	<i>Minimum luminous intensity in cd</i>	<i>Maximum luminous intensity in cd when used as</i>	
		<i>A single lamp</i>	<i>A lamp marked "D" (paragraph 3.3.2.5.2.)</i>
Front position lamps, front end-outline marker lamp A or AM	4	140	70
Front end-outline marker lamp MA	4	140	N.A.
Front position lamps incorporated in a headlamp	4	140	N.A.

5.1.2. Outside the reference axis the intensity of the light emitted by each lamp must in each direction corresponding to the points in the table of standard light distribution reproduced in Paragraph 2 of Annex 3, be not less than the minimum specified in paragraph 4.1.1. above, multiplied by the percentage specified in the said table of the direction in question.

5.1.3. Throughout the fields defined in the diagrams in Part A of Annex 2, the luminous intensity of the light emitted must be not less than 0.05 cd for front position lamps and front end-outline marker lamps;

5.1.4. The colour of the light emitted shall be white.

### 5.2 TECHNICAL REQUIREMENTS CONCERNING REAR POSITION LAMPS, (SYMBOLS R1, R2, MR) AND REAR END-OUTLINE MARKER LAMPS, (SYMBOLS RM1, RM2)

5.2.1. The light emitted by each of the two lampssupplied shall be not less than the minimum intensity in the reference axis as indicated in the table below and not more than the maximum luminous intensity in any direction the lamp is visible as indicated in the table below:

	<i>Minimum luminous intensity in cd</i>	<i>Maximum luminous intensity in cd when used as</i>	
		<i>A single lamp</i>	<i>A lamp marked "D" (paragraph 3.3.2.5.2.)</i>
Rear position lamps, rear end-outline marker lamp			
R1 or RM1 (steady)	4	17	8.5
MR	4	17	N.A.
R2 or RM2 (variable)	4	42	21

5.2.2. Outside the reference axis the intensity of the light emitted by each lamp must in each direction corresponding to the points in the table of standard light distribution reproduced in Paragraph 2 of Annex 3, be not less than the minimum specified in paragraph 5.2.1., multiplied by the percentage specified in the said table for the direction in question.

5.2.3. However, a luminous intensity of 60 cd shall be permitted for rear position lamps reciprocally incorporated with stop-lamps below a plane forming an angle of 5° with and downward from the horizontal plane;

5.2.4. Throughout the fields defined in the diagrams in Part A of Annex 2, the luminous intensity of the light emitted must be not less than 0.05 cd for rear position lamps and end-outline marker lamps,

5.2.5. The colour of light emitted shall be red.

This requirement shall also apply within the range of variable luminous intensity produced by:

- (a) Rear position lamps of category R2;
- (b) Rear end-outline marker lamps of category RM2;

### 5.3. TECHNICAL REQUIREMENTS CONCERNING PARKING LAMPS (SYMBOL 77R)

5.3.1. The light emitted by each of the two lampss supplied shall be not less than the minimum intensity in the reference axis as indicated in the table below and not more than the maximum luminous intensity in any direction the lamp is visible as indicated in the table below:

	<i>Minimum luminous intensity in cd</i>	<i>Maximum luminous intensity in cd</i>
forward facing parking lamps	2	60
rearward facing parking lamps	2	30

5.3.2. Outside the reference axis the intensity of the light emitted by each lamp shall, in each direction corresponding to the points in the table of standard light distribution reproduced in Paragraph 2 of Annex 3 , be not less than the

minimum specified in paragraph 5.3.1., multiplied by the percentage specified in the said table for the direction in question.

5.3.3. Throughout the fields defined in the diagrams in Part B of Annex 2, the luminous intensity of the light emitted must be not less than 0.05 cd for front and rear parking lamps and end-outline marker lamps;

5.3.4. The colour of light emitted shall:

- a) for forward facing parking lamps be white;
- b) for rearward facing parking lamps be red.

5.4. TECHNICAL REQUIREMENTS CONCERNING DAYTIME RUNNING LAMPS (SYMBOLS RL)

5.4.1. The light emitted by each of the two lamps supplied shall be not less than the minimum intensity in the reference axis as indicated in the table below and not more than the maximum luminous intensity in any direction the lamp is visible as indicated in the table below:

	<i>Minimum luminous intensity in cd</i>	<i>Maximum luminous intensity in cd</i>
Daytime running lamps	400	1200

5.4.2. Outside the reference axis the intensity of the light emitted by each lamp must, in each direction corresponding to the points in the table of standard light distribution reproduced in Paragraph 2 of Annex 3, be not less than the minimum specified in paragraph 5.4.1., multiplied by the percentage specified in the said table of the direction in question.

5.4.3. Moreover, throughout the field defined in the diagram in Part B of Annex 2, the intensity of the light emitted shall not be less than 1.0 cd.

5.4.4. In the case of a daytime running lamp containing more than one light source, the daytime running lamp shall comply with the minimum intensity required and the maximum intensity shall not be exceeded when all light sources are activated.

5.4.5. In case of failure of any one light source in a single lamp containing more than one light source, one of the following provisions shall apply:

- (a) The light intensity at the points of standard light distribution defined in Paragraph 2.1 of Annex 3 shall be at least 80 per cent of the minimum intensity required, or
- (b) The light intensity in the axis of reference shall be at least 50 per cent of the minimum intensity required, provided that a note in the communication form states that the lamp is only for use on a vehicle fitted with an operating tell-tale.

5.4.6. The colour of the light emitted shall be white.

5.4.7. The daytime running lamp shall be subjected to the heat resistance test specified in Annex 6

## 5.5 TECHNICAL REQUIREMENTS CONCERNING STOP-LAMPS (SYMBOLS S1, S2, S3, S4 MS)

5.5.1. : The light emitted by each of the two lampss supplied shall be not less than the minimum intensity in the reference axis as indicated in the table below and not more than the maximum luminous intensity in any direction the lamp is visible as indicated in the table below:

	<i>Minimum luminous intensity in cd</i>	<i>Maximum luminous intensity in cd when used as</i>	
		<i>A single lamp</i>	<i>A lamp marked "D" (paragraph 3.3.2.5.2.)</i>
Stop-lamps			
S1 (steady)	60	260	130
S2 (variable)	60	730	365
S3 (steady)	25	110	55
S4 (variable)	25	160	80
MS (steady)	40	185	N.A.

5.5.2. Outside the reference axis the intensity of the light emitted by each lamp shall, in each direction corresponding to the points in the table of standard light distribution reproduced in Paragraph 2 of Annex 3 (for S1, S2 and MS stop lamps), or Paragraph 3 of Annex 3 (for S3 and S4 stop lamps), be not less than the minimum specified in paragraph 4.5.1., multiplied by the percentage specified in the said table of the direction in question.

5.5.3. Throughout the fields defined in the diagrams in Part A of Annex 2, the luminous intensity of the light emitted shall be not less than 0.3 cd for stop-lamps;

5.5.4. The colour of the light emitted shall be red.

In the case of a category S3 or S4 stop lamp, which is intended to be mounted inside the vehicle, the colorimetric characteristics shall be verified with the worst case combination(s) of lamp and rear window(s) or sample plate(s).

These requirements shall also apply within the range of variable luminous intensity produced by Stop lamps of categories S2 and S4.

## 5.6 TECHNICAL REQUIREMENTS CONCERNING DIRECTION-INDICATOR LAMPS (Symbols 1, 1a, 1b, 2a, 2b, 5, 6, 11, 11a, 11b, 11c, 12)

5.6.1. The light emitted by each of the two lamps supplied shall be not less than the minimum intensity in the reference axis as indicated in the table below and not more than the maximum luminous intensity in any direction the lamp is visible as indicated in the table below: and:

- a) in the case of direction indicators of categories 1, 1a, 1b, 2a, 2b, 11, 11a, 11b, 11c, 12 in the reference axis not less than the minimum intensity, or
- b) in the case of direction indicators of categories 5 or 6 in direction A according to Annex 2 not less than the minimum intensity.

<i>Direction</i>	<i>Minimum luminous</i>	<i>Maximum luminous intensity in cd when used as</i>
------------------	-------------------------	--



<i>indicator of category</i>	<i>intensity in cd</i>	<i>A single lamp</i>	<i>A lamp marked "D" (paragraph 3.3.2.5.2.)</i>
1	175	1000	500
1a	250	1200	600
1b	400	1200	600
2a (steady)	50	500	250
2b (variable)	50	1000	500
5	0.6	280	140
6	50	280	140
11	90	1000	N.A.
11a	175	1000	N.A.
11b	250	1200	N.A.
11c	400	1200	N.A.
12	50	500	N.A.

5.6.2. Outside the reference axis the intensity of the light emitted by each lamp shall, in each direction corresponding to the points in the table of standard light distribution reproduced in

- a) Paragraph 2.1 of Annex 3 for categories 1, 1a, 1b, 2a, 2b, 11, 11a, 11b, 11c, 12. or
- b) Paragraph 2.3 of Annex 3 for category 5, or
- c) Paragraph 2.4 of Annex 3 for category 6,

be not less than the minimum specified in paragraph 4.6.1., multiplied by the percentage specified in the said table of the direction in question.

5.6.3. Failure provisions

For direction-indicator lamps of categories 1, 1a, 1b, 2a and 2b a signal for activation of the tell-tale prescribed in paragraph 6.5.8. of Regulation No. 48 shall be produced if (notwithstanding the provisions stated in paragraph 4.6):

- (a) Any one light source has failed, or
- (b) In the case of a lamp designed for only two filament light sources, the intensity in the axis of reference is less than 50 per cent of the minimum intensity, or
- (c) As a consequence of a failure of one or more light sources, the intensity in one of the following directions as indicated in Annex 4 to this Regulation is less than the minimum intensity required:
  - (i)  $H=0^\circ, V=0^\circ$
  - (ii)  $H=20^\circ$  to the outside of the vehicle,  $V=+5^\circ$
  - (iii)  $H=10^\circ$  to the inside of the vehicle,  $V=0^\circ$ .

- 5.6.4. Test procedure:
- 5.6.4.1. In divergence from paragraphs 3.8.2.3. and 3.8.2.3.1., for category 5 direction indicators, to the rear, a minimum value of 0.6 cd is required throughout the fields specified in Part A of Annex 2;
- 5.6.5. Throughout the fields defined in the diagrams in Part A of Annex 2, the intensity of the light emitted shall be not less than 0.7 cd for lamps of category 1b, not less than 0.3 cd for lamps of categories 1, 1a, 2a, 11, 11a, 11b, 11c, 12 and for those of category 2b by day; it shall not be less than 0.07 cd for lamps of category 2b by night;
- 5.6.6. In general the intensities shall be measured with the light source(s) continuously alight.
- However, depending on the construction of the lamp, for example, the use of light-emitting diodes (LED), or the need to take precautions to avoid overheating, it is allowed to measure the lamps in flashing mode.
- a) This shall be achieved by switching with a frequency of  $f = 1.5 \pm 0.5$  Hz with the pulse width greater than 0.3 s, measured at 95 per cent peak light intensity. In all other cases the voltage as required in paragraph 4.7.1. shall be switched with a rise time and fall time shorter than 0.01 s; no overshoot is allowed.
- b) In the case of measurements taken in flashing mode the reported luminous intensity shall be represented by the maximum intensity.
- 5.6.7. In the case of lamps of category 2b the time that elapses between energizing the light source(s) and the light output measured on the reference axis to reach 90 per cent of the value measured in accordance with paragraph 4.8.3.2. shall be measured for the extreme levels of luminous intensity produced by the direction indicator. The time measured to obtain the lowest luminous intensity shall not exceed the time measured to obtain the highest luminous intensity.
- 5.6.8. The variable intensity control shall not generate signals which cause luminous intensities outside the range specified in paragraph 5.6.1. and exceeding the category 2a maximum specified in paragraph 5.6.1.:
- (a) For systems depending only on daytime and night time conditions: under night time conditions;
- (b) For other systems: under reference conditions as demonstrated by the manufacturer.<sup>2</sup>
- 5.6.9. The colour of the light emitted shall be amber.
- 5.6.10. For any direction indicator lamp except those equipped with filament light source(s), the luminous intensities measured after one minute and after 30 minutes of operation in flashing mode ( $f = 1.5$  Hz, duty factor 50 per cent), shall comply with the minimum and maximum requirements. The luminous intensity distribution after one minute of operation can be calculated by

---

<sup>2</sup> Good visibility (meteorological optical range MOR > 2,000 m defined according to WMO, Guide to Meteorological Instruments and Methods of Observation, Sixth Edition, ISBN: 92-63-16008-2, pp 1.9.1/1.9.11, Geneva 1996 ) and clean lens.

applying at each test point the ratio of luminous intensity measured in HV after one minute and after 30 minutes of operation as above described.

5.6.11. For direction indicator lamps of categories 1, 1a, 1b, 2a or 2b the flash may be produced by sequential activation of their light sources if the following conditions are met:

- (a) Each light source, after its activation, shall remain lit until the end of the ON cycle;
- (b) The sequence of activation of the light sources shall produce a signal which proceeds in a uniform progressive manner from inboard towards the outboard edge of the light emitting surface when fitted on the vehicle;
- (c) It shall be one signal with no interruption and no vertical oscillations (e.g. not more than one change of direction along the vertical axis). The distance between two adjacent/tangential distinct parts of the light emitting surface of the sequential direction indicator shall not exceed 50 mm, when measured perpendicularly to the reference axis, instead of the values defined in paragraph 5.7.2. of Regulation No. 48. These interruptions of the signal shall not create any overlap in the vertical axis between the different parts, from inboard towards the outboard of the vehicle, and shall not be used for any other lighting or light signalling functions;
- (d) The variation shall finish no more than 200 ms after the beginning of the ON cycle;
- (e) The orthogonal projection of the light emitting surfaces of the direction indicator in the direction of the axis of reference shall be circumscribed by a rectangle on a plane normal to the axis of reference and having its longer sides parallel to the H-plane. The ratio of the horizontal to the vertical sides shall not be less than 1.7;
- (f) A direction indicator capable of being activated in different modes (sequential or not) shall not mix both signals simultaneously. The front or the rear direction indicators installed on the same side of the vehicle shall not operate in different modes.

Compliance to the conditions mentioned above shall be verified in flashing mode.

5.7. TECHNICAL REQUIREMENTS CONCERNING SIDE MARKER LAMPS (SYMBOLS SM1, SM2)

5.7.1. The light emitted by each of the two lamps supplied shall be not less than the minimum intensity in the reference axis as indicated in the table below and not more than the maximum luminous intensity in any direction the lamp is visible as indicated in the table below:

Side-Marker Lamp Category		SM1	SM2
Minimum intensity	In the axis of reference	4.0 cd	0.6 cd
	Within the specified angular field, other than above	0.6 cd	0.6 cd

Side-Marker Lamp Category		SM1	SM2
Maximum intensity	Within the specified angular field <sup>1</sup>	25.0 cd	25.0 cd
Angular field	Horizontal	±45 deg.	±30 deg.
	Vertical	±10 deg.	±10 deg.

<sup>1</sup> In addition, for red side-marker lamp, in the angular field from 60° to 90° in horizontal direction and ±0° in vertical direction towards the front of the vehicle, the maximum intensity is limited to 0.25 cd.

5.7.2. Outside the reference axis and within the angular fields defined in the diagrams in Part C of Annex 2, the intensity of the light emitted by each of the two side-marker lamps supplied shall:

- a) in each direction corresponding to the points in the light distribution table reproduced in Paragraph 2.7 of Annex 3, be not less than the product of the minimum specified in paragraph 5.7.1. by the percentage specified in the said table for the direction in question;
- b) in no direction within the space from which the side-marker lamp is visible, exceed the maximum specified in paragraph 5.7.1.

5.7.3. For SM1 and SM2 categories of side-marker lamps it may be sufficient to check only five points selected by the Type Approval Authority.

5.7.4. The colour of the light emitted shall be amber. However it can be red, if the rearmost side-marker lamp is grouped or combined or reciprocally incorporated with the rear position lamp, the rear end-outline marker lamp, the rear fog lamp, the stop lamp, or is grouped with or has part of the light emitting surface in common with the rear retro-reflector.

#### 5.8. TECHNICAL REQUIREMENTS CONCERNING REVERSING LAMPS (SYMBOLS AR)

5.8.1. The light emitted by each of the two lamps supplied shall be in the reference axis, of not less than the minimum intensity and of not more than the maximum intensity specified below: The light emitted by each of the two lamps supplied shall be not less than the minimum intensity in the reference axis as indicated in the table below and not more than the maximum luminous intensity in any direction the lamp is visible as indicated in the table below:

	<i>Minimum luminous intensity in cd</i>	<i>Maximum luminous intensity in cd</i>		
		in or above the h plane	below the h plane, down to 5°D	below 5°D
Reversing lamps	80	300	600	8000

5.8.2. The light intensity at the points of standard light distribution is defined in Paragraph 2.5 of Annex 3

5.8.3 The colour of the light emitted shall be white.

5.9 TECHNICAL REQUIREMENTS CONCERNING REAR FOG LAMPS (SYMBOLS F1, F2)

5.9.1. The light emitted by each of the two lamps supplied shall be not less than the minimum intensity in the reference axis as indicated in the table below and not more than the maximum luminous intensity in any direction the lamp is visible as indicated in the table below:

	<i>Minimum luminous intensity in cd</i>	<i>Maximum luminous intensity in cd</i>
F1 rear fog lamps (steady luminous intensity)	150	300
F2 rear fog lamps (variable luminous intensity)	150	840

5.9.2. The light intensity at the points of standard light distribution is defined in Paragraph 2.6 of Annex 3

5.9.3. The variable intensity control shall not generate signals which cause luminous intensities outside the range specified in paragraph 5.9.1. and exceeding the category F1 maximum specified in paragraph 5.9.1.:

- (a) for systems depending only on daytime and night time conditions: under night time conditions;
- (b) for other systems: under standard conditions<sup>3</sup>

5.9.4. The apparent surface in the direction of the reference axis shall not exceed 140 cm<sup>2</sup>.

5.9.5. The colour of the light emitted shall be red.

5.9.6. The rear fog lamp shall be subjected to the test specified in Annex 6.

5.10. TECHNICAL REQUIREMENTS CONCERNING MANOEUVRING LAMPS (SYMBOLS ML)

5.10.1. The intensity of light emitted shall not exceed 500 cd in all directions in which the light can be observed, when installed in any mounting position specified by the applicant.

5.10.2. The lamp must be so designed that the light emitted directly towards the side, the front or the rear of the vehicle does not exceed 0.5 cd within the angular field as defined below.

- (a) The vertical minimum angle  $\varphi_{\min}$  (in degrees) is:  
 $\varphi_{\min} = \arctan (1\text{-mounting height})/10$ ; where h is mounting height in m
- (b) The vertical maximum angle  $\varphi_{\max}$  (in degrees) is:  $\varphi_{\max} = \varphi_{\min} + 11.3$

<sup>3</sup> Good visibility (meteorological optical range MOR > 2,000 m defined according to WMO, Guide to Meteorological Instruments and Methods of Observation, Sixth Edition, ISBN: 92-63-16008-2, pp .9.1/1.9.11, Geneva 1996.) and clean lens.

The measurement shall be limited to a horizontal angle ranging from +90° to -90° with respect to the line which cuts the reference axis and which is perpendicular to the vertical longitudinal plane of the vehicle.

The measurement distance shall be 3.0 m minimum.

5.10.3. The colour of the light emitted shall be white.

5.11. TECHNICAL REQUIREMENTS CONCERNING REAR-REGISTRATION PLATE ILLUMINATING DEVICES (SYMBOL "L-1A", L-1B, L-1C, L-2A, L-2B)

The devices for the illumination of rear-registration plates shall be so constructed that the whole surface of the plate will be visible within the angles given in Part D of Annex 2.

5.11.1. Measuring procedure

However, the luminance measurements shall be made on a diffuse colourless surface with known diffuse reflection factor<sup>4</sup>. The diffuse colourless surface shall have the dimensions of the registration plate or the dimension exceeding one measuring point. Its centre shall be placed in the centre of the positions of the measuring points.

This diffuse colourless surface(s) shall be placed in the position normally occupied by the registration plate and 2 mm in front of its holder.

Luminance measurements shall be made perpendicularly to the surface of the diffuse colourless surface with the tolerance of 5° in each direction at the points shown in Paragraph 3 Annex 3, each point representing a circular area of 25 mm in diameter. The measured luminance shall be corrected for the diffuse reflection factor 1.0.

5.11.2. Photometric characteristics

At each of the points of measurement shown in Paragraph 3 Annex 3, the luminance B shall be at least equal to 2.5 cd/m<sup>2</sup>.

The gradient of the luminance between the values B<sub>1</sub> and B<sub>2</sub>, measured at any two points 1 and 2 selected from among those mentioned above, shall not exceed 2 x B<sub>0</sub>/cm, B<sub>0</sub> being the minimum luminance measured at the various points, i.e.:

$$\frac{B_2 - B_1}{\text{distance 1 - 2 in cm}} \leq 2 \times B_0/\text{cm}$$

5.11.3. The colour of the light emitted shall be white.

## 6. Transitional Provisions

This section is reserved for future use

<sup>4</sup> CIE Publication No.17 –1970, paragraph 45-20-040

## Annex 1

### Communication

(Maximum format: A4 (210 x 297 mm))

	issued by:	Name of Administration: ..... ..... ..... .....
	Concerning <sup>2</sup> :	Approval granted Approval extended Approval refused Approval withdrawn Production definitively discontinued
of a type of lamp pursuant to Regulation No. <b>LSD</b>		
Lamp <sup>2</sup> :	Rear-registration plate illuminating device Direction indicator Stop lamp Position lamp End-outline marker lamp Reversing lamp Manoeuvring lamp Rear fog lamp Parking lamp Daytime running lamp Side marker lamp	for a vehicle / motorcycle
Approval No:	Extension No:	
Unique Identifier (UI) (If applicable)		

<sup>1</sup> Distinguishing number of the country which has granted/extended/refused/withdrawn approval (see approval provisions in the Regulation)

<sup>2</sup> Strike out what does not apply.

1. Trade name or mark of the lamp: .....
2. Manufacturer's name for the type of lamp: .....
3. Manufacturer's name and address: .....
4. If applicable, name and address of the manufacturer's representative: .....  
.....
5. Submitted for approval on: .....
6. Technical Service responsible for conducting approval tests: .....
7. Date of report issued by that Service: .....
8. Number of report issued by that Service: .....
9. Concise description:
  - 9.1. In case of
    - 9.1.1. A rear-registration plate illuminating device: .....  
Geometrical conditions of installation (position(s) and inclination(s) of the device in relation to the space to be occupied by the registration plate and/or different inclinations of this space): .....
    - 9.1.2. A direction indicator: .....  
Sequential activation of light sources: yes/no<sup>2</sup>
    - 9.1.3. A reversing lamp:  
The lamp shall be installed on a vehicle only as part of a pair of lamps: yes/no<sup>2</sup>
    - 9.1.4. A manoeuvring lamp:  
The maximum mounting height: .....
  - 9.2. By light signalling function and category:  
For mounting either outside or inside or both<sup>2</sup>  
Colour of light emitted: red/white/amber/colourless<sup>2</sup>  
Number, category and kind of light source(s): .....  
Voltage and wattage: .....  
Light source module: yes/no<sup>2</sup>  
Light source module specific identification code: .....  
Only for installation on M<sub>1</sub> and/or N<sub>1</sub> category vehicles: yes/no<sup>2</sup>  
Only for limited mounting height of equal to or less than 750 mm above the ground, if applicable: yes/no<sup>2</sup>.....  
Geometrical conditions of installation and relating variations, if any: .....  
Application of an electronic light source control gear/variable intensity control:
    - (a) Being part of the lamp: yes/no<sup>2</sup>
    - (b) Being not part of the lamp: yes/no<sup>2</sup>



- 
- Input voltage(s) supplied by an electronic light source control gear/variable intensity control: .....
- Electronic light source control gear/variable intensity control manufacturer and identification number (when the light source control gear is part of the lamp but is not included into the lamp body): .....
- Variable luminous intensity, if applicable: yes/no<sup>2</sup>
- Function(s) produced by an interdependent lamp forming part of an interdependent lamp system, if applicable: .....
10. Position of the approval mark: .....
11. Reason(s) for extension (if applicable): .....
- .....
12. Approval granted/extended/refused/withdrawn<sup>2</sup>: .....
13. Place: .....
14. Date: .....
15. Signature: .....
16. The list of documents deposited with the Type Approval Authority which has granted approval is annexed to this communication and may be obtained on request.
- .....
- .....
- .....
- .....
- .....

## Annex 2

### Light distribution in space, horizontal and vertical

The angles shown in these arrangements are correct for lamps to be mounted on the right side of the vehicle.

#### Part A: Position, end-outline marker, stop, front and rear direction indicators, daytime running and front and rear parking lamps

Required light-distribution in space – Horizontal and Vertical

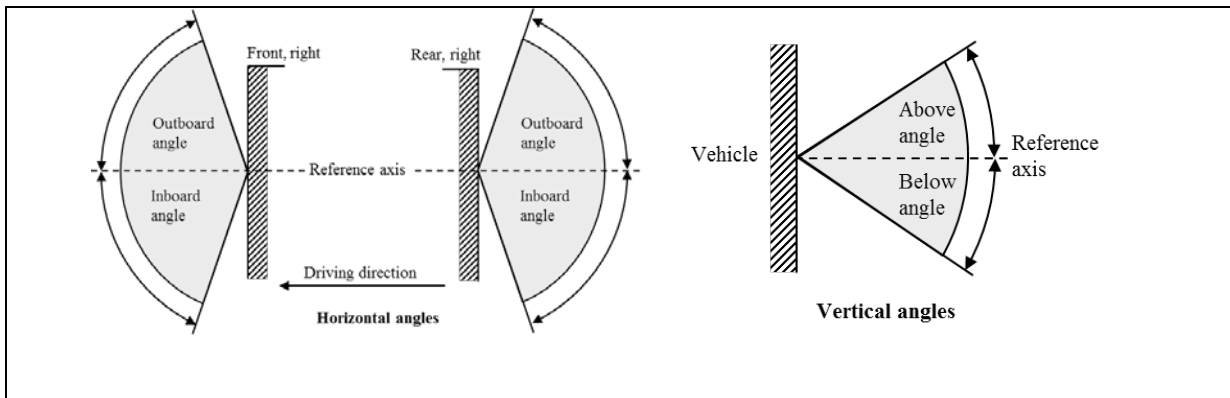

Lamp	Minimum horizontal angles (inboard / outboard)	Minimum vertical angles (above / below)	Additional information
Front direction indicator (1, 1a, 1b)	45° / 80° 20° / 80° <sup>2</sup>	15° / 15° 15° / 5° <sup>3</sup>	-
Rear direction indicator (2a, 2b)	45° / 80° 20° / 80° <sup>5</sup>	15° / 15° 15° / 5° <sup>3</sup> 5° / 15° <sup>4</sup>	-
Front direction indicator (11, 11a, 11b, 11c) Rear direction indicator (12)	20° / 80°	15° / 15°	-
Front position singular (MA) Rear position singular (MR)	80° / 80°	15° / 10°	
Front position pair (MA) Rear position pair (MR)	45° / 80°	15° / 10°	
Stop (MS) Rear position (R, R1, R2)	45° / 45°	15° / 10°	
Front parking (77R) Rear parking (77R)	0° / 45°	15° / 15° 15° / 5° <sup>3</sup>	-
Front end-outline marker (AM) Rear end-outline marker (RM1, RM2)	0° / 80°	15° / 15° 15° / 5° <sup>3</sup>	-

<sup>3</sup> For lamps to be installed with the H-plane of the lamp at a mounting height of less than 750 mm

<sup>4</sup> Optional lamps to be installed with the H-plane of the lamp at a mounting height of more than 2100 mm

		5° / 15° <b>Errore. Il segnalibro non è definito.</b>	
Front position (A) Rear position (R, R1, R2)	45° / 80° 20° / 80° <sup>5</sup>	15° / 15° 15° / 5° <sup>3</sup> 5° / 15° <b>Errore. Il segnalibro non è definito.</b>	-
Stop lamp (S1, S2)	45° / 45° 20° / 45° <sup>5</sup>	15° / 15° 15° / 5° <sup>3</sup> 5° / 15° <b>Errore. Il segnalibro non è definito.</b>	
High mounted stop lamp (S3, S4)	10° / 10°	10° / 5°	-
Daytime running lamps (RL)	20° / 20°	10° / 5°	

## Part B: Side direction indicators and side parking lamps<sup>6</sup>

Required light-distribution in space – Horizontal and Vertical

Lamp	Horizontal angles (A/B)	Min. vertical angles (above/below)	Additional information
Side direction indicators (5)	Max. 5° / Min. 55°	15° / 15°	Horizontal angles apply to
Side direction indicators (6)	Max. 5° / Min. 55°	30° / 5°	Direction A
Side parking	Max. 0° / Min. 45°	15° / 15° 15° / 5° <sup>3</sup>	Horizontal angles apply to front and rear

<sup>5</sup> Below the H-plane for lamps mounted with the H-plane below 750 mm

<sup>6</sup> Side parking lamps are a combination of front and rear facing parking lamps

## Part C: Side marker lamps

Required light-distribution in space – Horizontal and Vertical

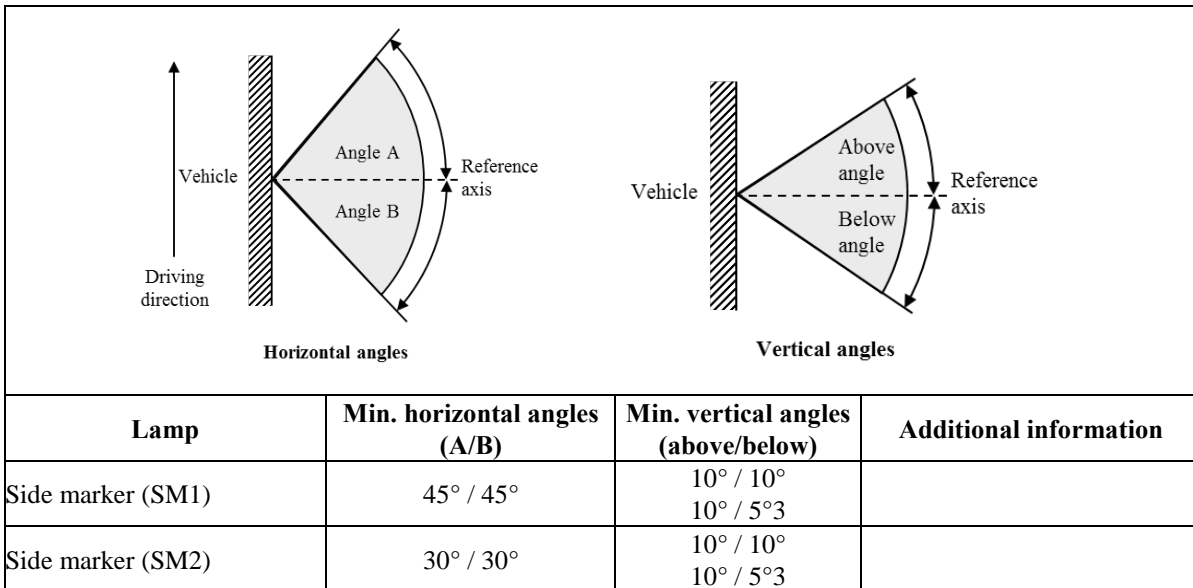

## Part D: Rear-registration plate illuminating devices, field of visibility

Required light-distribution in space – Horizontal and Vertical

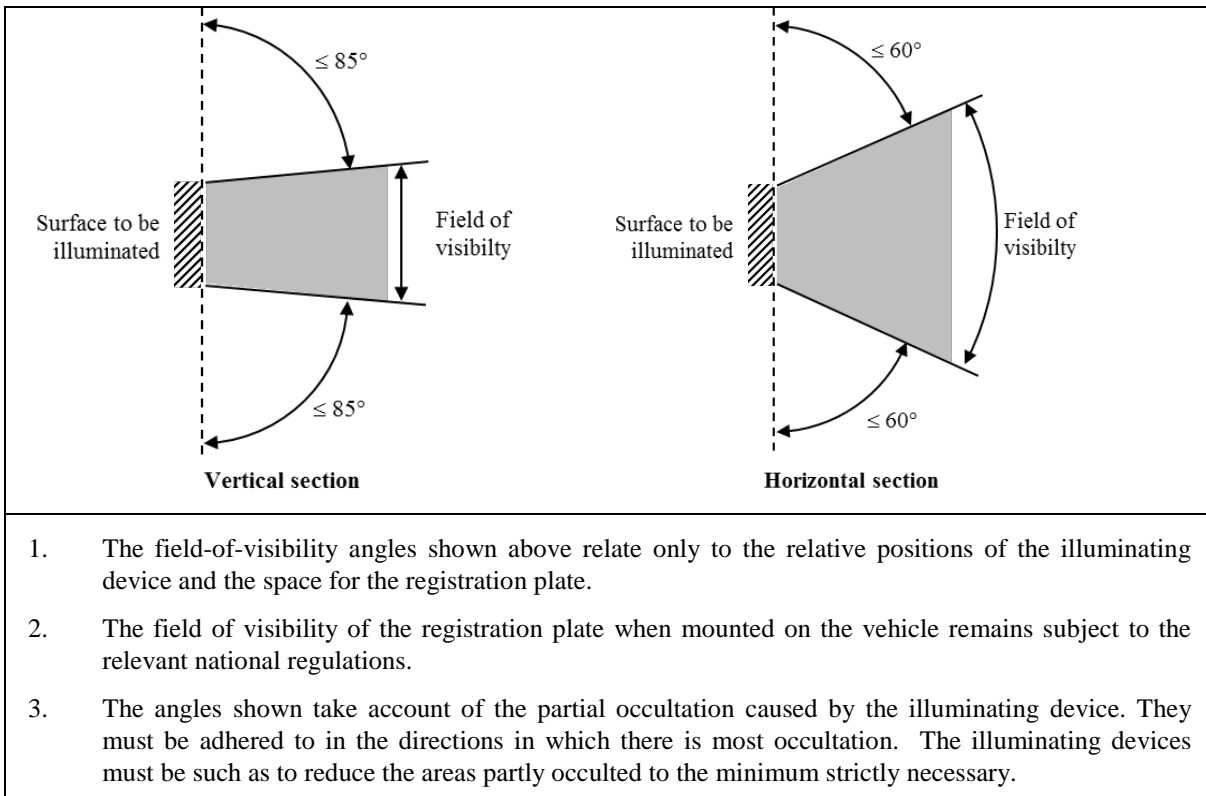

## Annex 3

### Standard light distributions

1. If not otherwise specified:
  - 1.1. The direction  $H = 0^\circ$  and  $V = 0^\circ$  corresponds to the reference axis. (On the vehicle, it is horizontal, parallel to the median longitudinal plane of the vehicle and oriented in the required direction of visibility.) It passes through the centre of reference. The values shown in the tables give, for the various directions of measurement, the minimum intensities as a percentage of the minimum intensities required.
  - 1.2. Within the field of light distribution schematically shown as a grid, the light pattern should be substantially uniform, i.e. the light intensity in each direction of a part of the field formed by the grid lines shall meet at least the lowest minimum value being shown on the grid lines surrounding the questioned direction as a percentage.
2. Standard light distribution
  - 2.1 Standard light distribution for front and rear position lamps, stop lamps (S1, S2 and MS) and direction indicator lamps of categories 1, 1a, 1b, 2a, 2b, 11, 11a, 11b, 11c, 12.

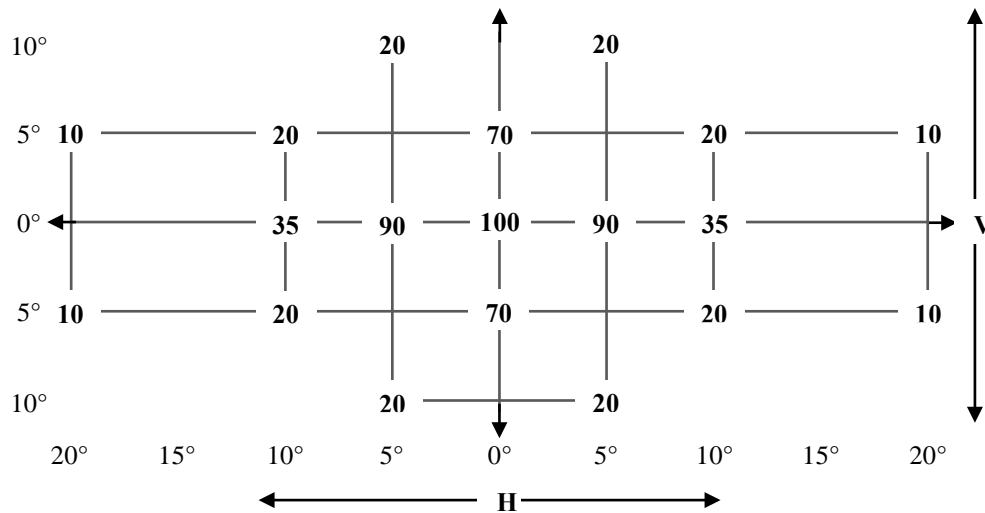

- 2.1 Standard light distribution for Daytime Running Lamps

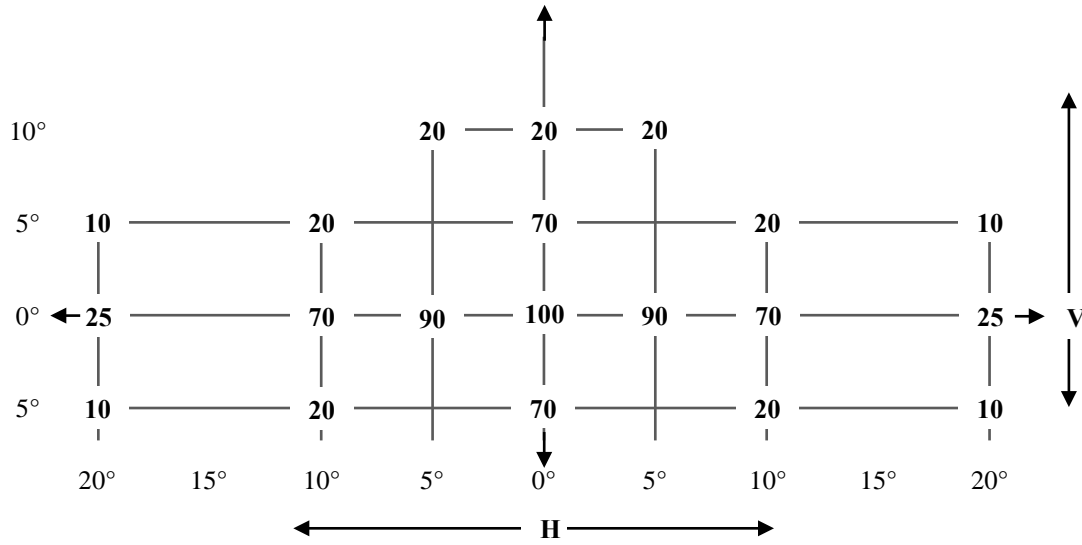

2.2 Standard light distribution for category S3 and S4 stop-lamp

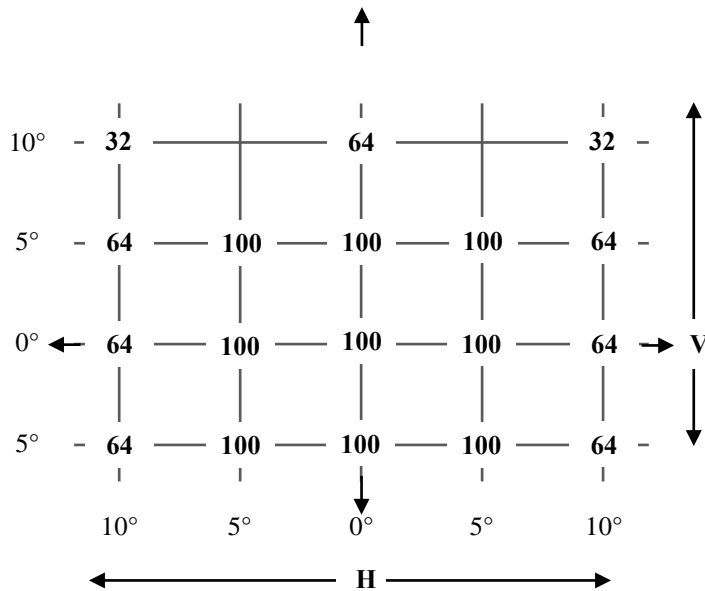

2.3 Standard light distribution for direction indicators of category 5

The reference axis,  $H = 0^\circ$  and  $V = 0^\circ$ , corresponds to the direction A as prescribed in Annex 2

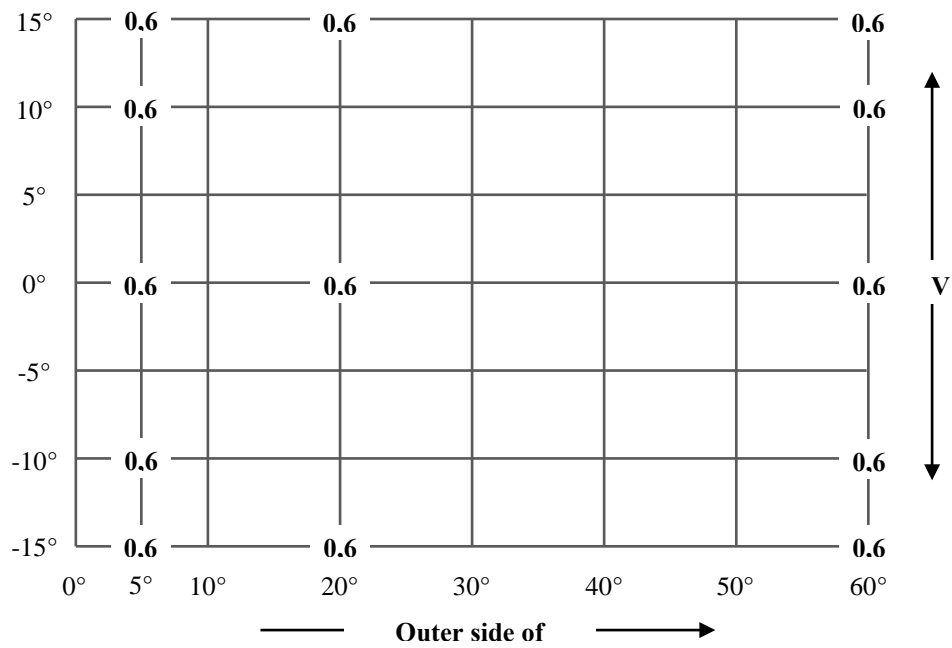

#### 2.4 Standard light distribution for direction indicators of category 6

The reference axis,  $H = 5^\circ$  and  $V = 0^\circ$ , corresponds to the direction A as prescribed in Annex 2

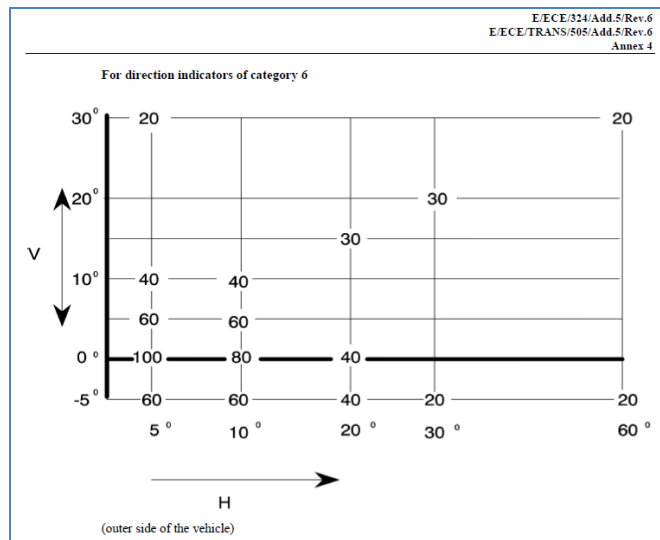
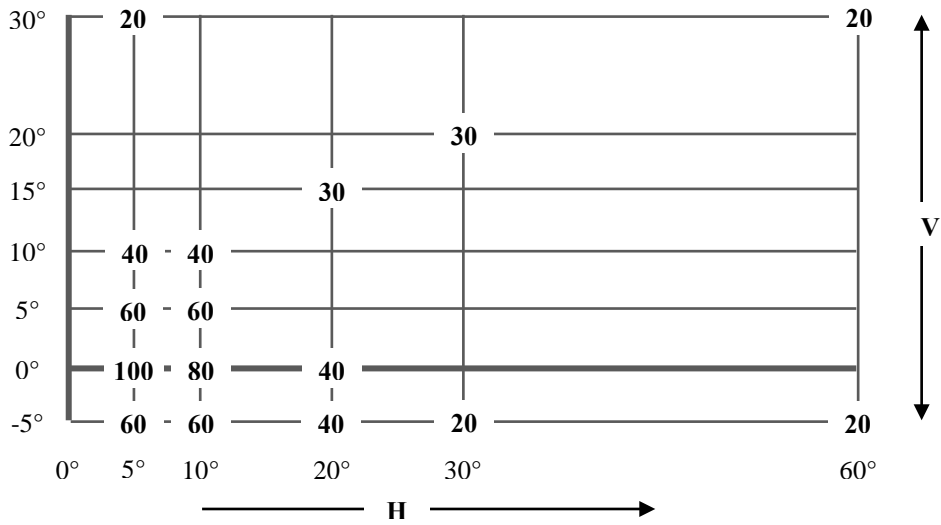

(outer side of the vehicle)

## 2.5 Standard light distribution for reversing lamps

The measuring points expressed in degrees of angle with the axis of reference and values of the minimum intensities of the light emitted.



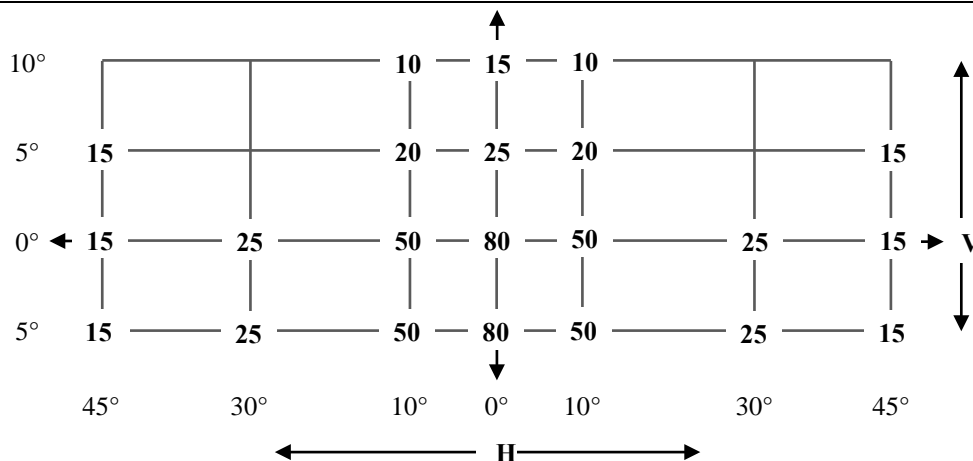

The values inside the table are in cd.

The directions  $H = 0^\circ$  and  $V = 0^\circ$  correspond to the axis of reference. On the vehicle they are horizontal, parallel to the median longitudinal plane of the vehicle and oriented in the required direction of visibility. They pass through the centre of reference. The values shown in the table give, for the various directions of measurement, the minimum intensities in cd.

## 2.6 Standard light distribution for rear fog lamps

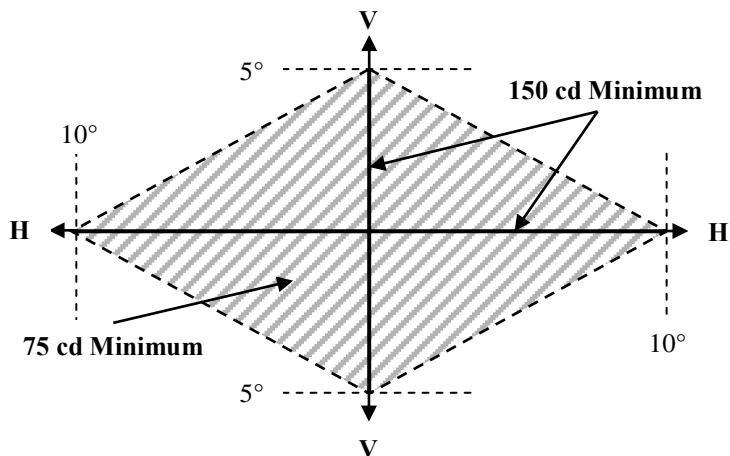

If visual examination of a light appears to reveal substantial local variations of intensity, a check shall be made to ensure that, outside the axes, no intensity measured within the rhombus defined by the extreme directions of measurement is below 75 cd (see diagram above).

## 2.7. Standard light distribution for side-marker lamps

### 2.7.1. SM1 category of side-marker lamps

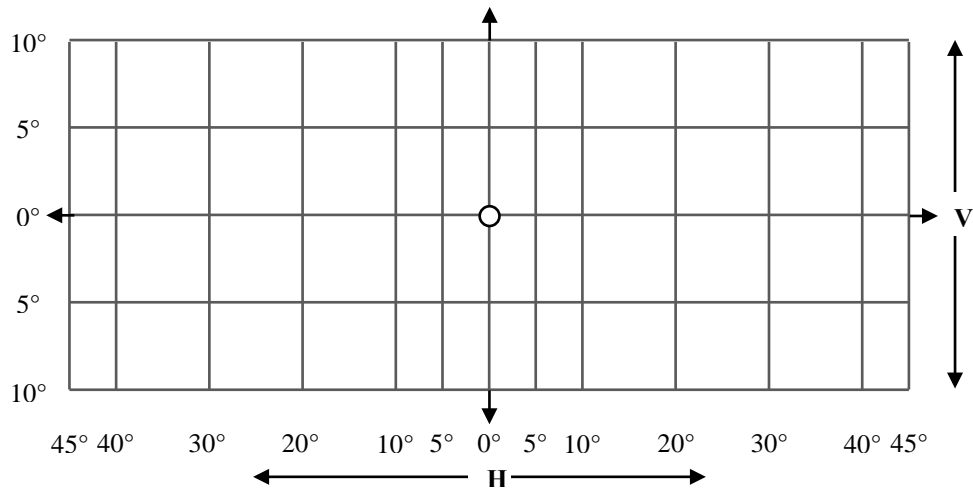

2.7.2. SM2 category of side-marker lamps

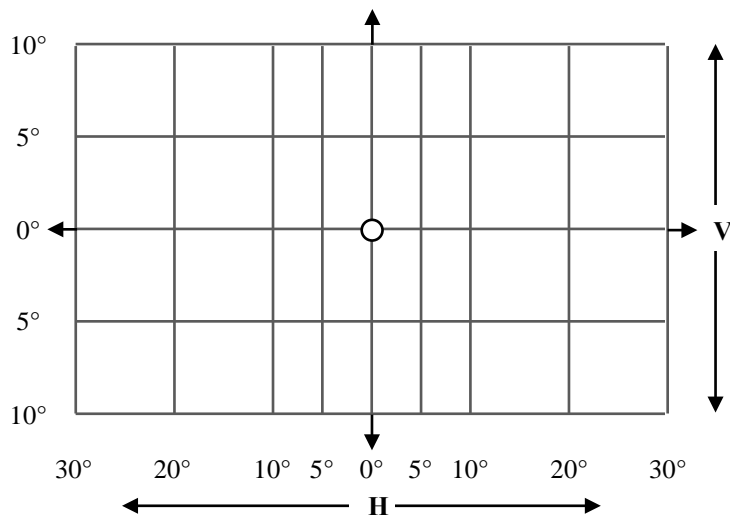

2.7.3. SM1 and SM2 category of side-marker lamps

For SM1 and SM2 category of side-marker lamps it may be sufficient to check only five points selected by the Type Approval Authority.

3. Measurement points for rear-registration plate illuminating devices

3.1 Category 1a - tall plate (340 x 240 mm)

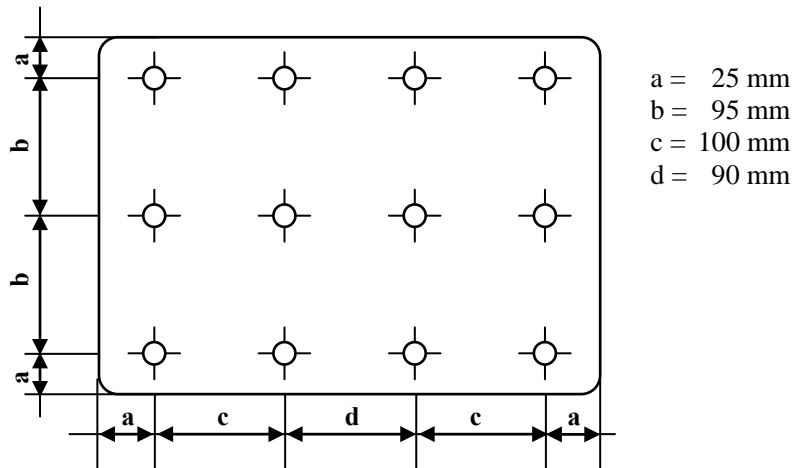

3.2 Category 1b - wide plate (520 x 120 mm)

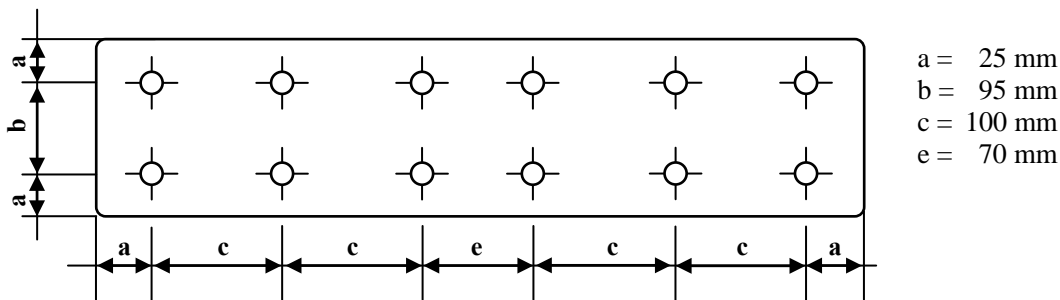

3.3. Category 1c - plate for agricultural or forestry tractors (255 x 165 mm)

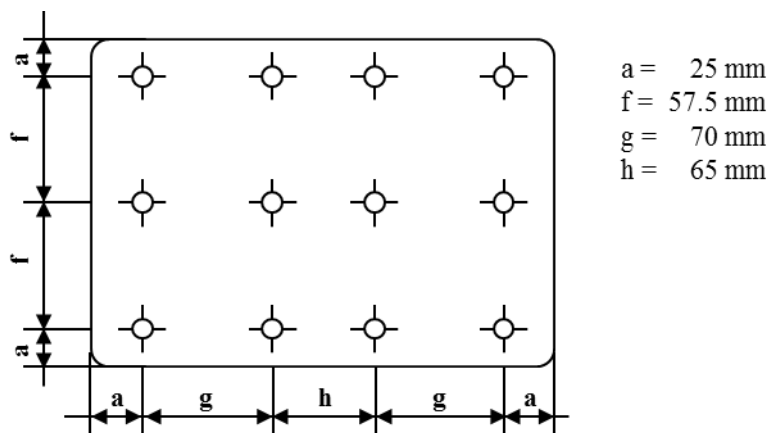

3.4. Category 2a - small plate (330 x 165 mm)

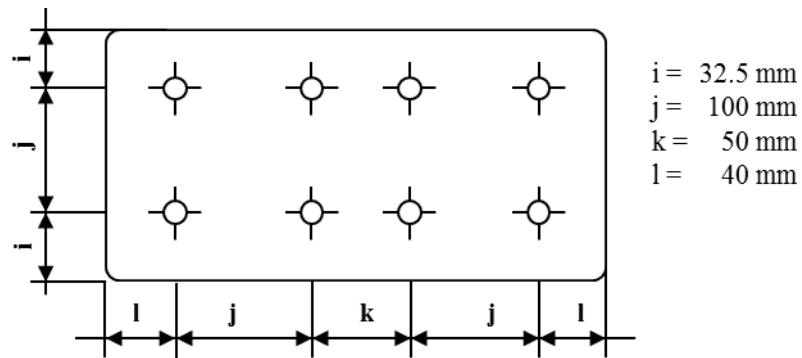

3.5. Category 2b – wide plate (440 x 220 mm)

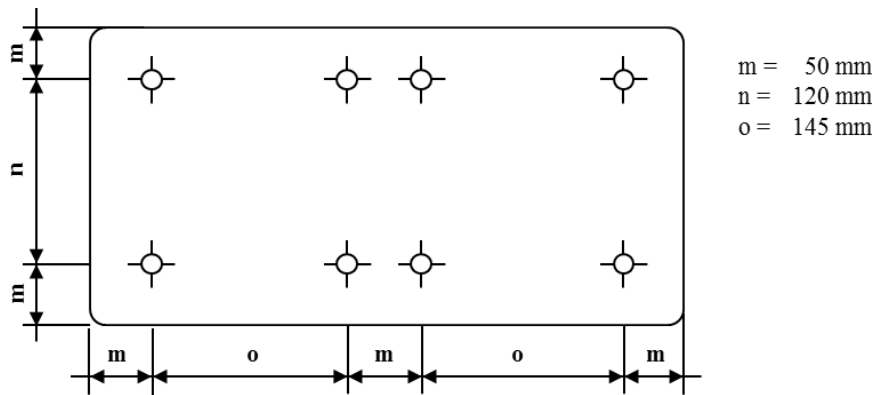

*Note:* In the case of devices for illuminating two or all of the plates, the measurement points used are obtained by combining the corresponding drawings above in accordance with the outline indicated by the make or manufacturer; however, if two measurement points are less than 30 mm apart, only one shall be used.

3.6. Category 1 (240 x 130 mm) for vehicles of class L

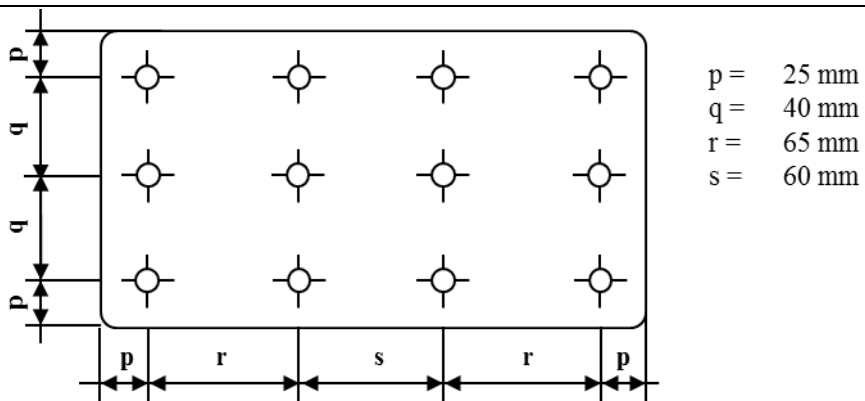

3.7. Category 2 (280 x 200 mm) for vehicles of class L

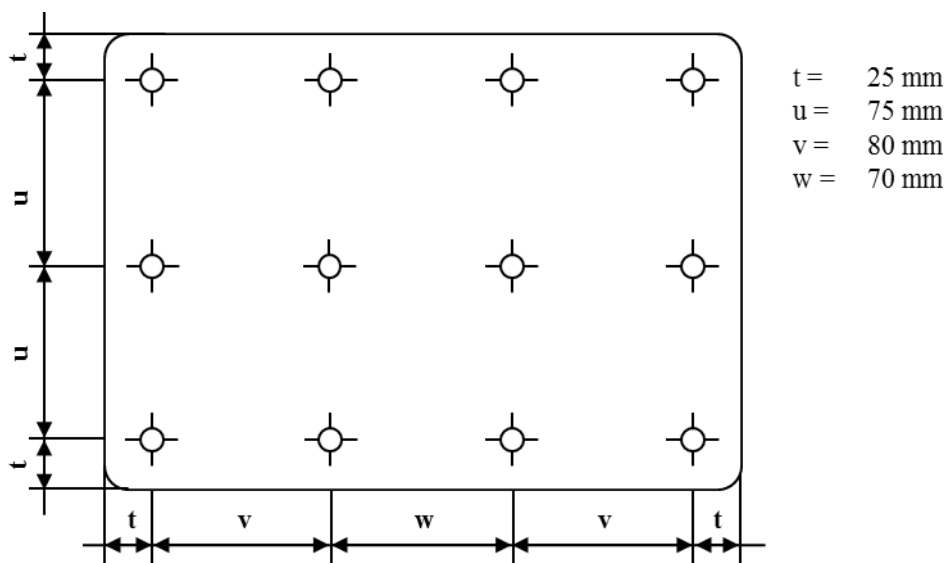

## Annex 4

### Minimum requirements for conformity of production control procedures

1. General
  - 1.1. The conformity requirements shall be considered satisfied from a mechanical and geometric standpoint, if the differences do not exceed inevitable manufacturing deviations within the requirements of this Regulation.
  - 1.2. With respect to photometric performances, the conformity of mass-produced lamps shall not be contested if, when testing photometric performances of any lamp chosen at random according to paragraph 3.7 of this Regulation.
    - 1.2.1. No measured value deviates unfavourably by more than 20% from the values prescribed in this Regulation

For the minimum values required throughout the fields specified in Annexes 2 and 3 the respective maximum deviations of the measured values shall correspond to the values shown in the table below:

Required minimum value	Equivalent 20 per cent	Equivalent 30 per cent
cd	cd	cd
0,7	0,5	0,3
0,6	0,4	0,2
0,3	0,2	0,1
0,07	0,05	0,03
0,05	0,03	0,02

- 1.2.1.1. For rear-registration plate illuminating devices:  
With respect to the gradient of luminance the unfavourable deviation shall be:

Unfavourable deviation		
2.5 x Bo/cm	comparable to	20 per cent
3.0 x Bo/cm	comparable to	30 per cent

- 1.2.2. If, in the case of a lamp equipped with a replaceable light source and if results of the test described above do not meet the requirements, tests on lamps shall be repeated using another standard light source.
- 1.3. The chromaticity coordinates shall be complied with when tested under conditions of paragraph 4.7 of this Regulation.
- 1.4. In the case of non-replaceable filament light source(s) or light source module(s) equipped with non-replaceable filament light source, at any conformity of production check:

- 
- 1.4.1. the holder of the approval mark shall demonstrate the use in normal production and show the identification of the non-replaceable filament light source(s) as indicated in the type approval documentation;
- 1.4.2. in the case where doubt exists in respect to compliance of the non-replaceable filament light source(s) with lifetime requirements and/or, in the case of colour coated filament light sources, with colour endurance requirements, as specified in paragraph 4.11 of IEC 60809, Edition 3, conformity shall be checked as specified in paragraph 4.11 of IEC 60809, Edition 3.
2. Minimum requirements for verification of conformity by the manufacturer
- For each type of lamp the holder of the approval mark shall carry out at least the following tests, at appropriate intervals. The tests shall be carried out in accordance with the provisions of this Regulation.
- If any sampling shows non-conformity with regard to the type of test concerned, further samples shall be taken and tested. The manufacturer shall take steps to ensure the conformity of the production concerned.
- 2.1. Nature of tests
- Tests of conformity in this Regulation shall cover the photometric and colorimetric characteristics.
- 2.2. Methods used in tests
- 2.2.1. Tests shall generally be carried out in accordance with the methods set out in this Regulation.
- 2.2.2. In any test of conformity carried out by the manufacturer, equivalent methods may be used with the consent of the competent authority responsible for approval tests. The manufacturer is responsible for proving that the applied methods are equivalent to those laid down in this Regulation.
- 2.2.3. The application of paragraphs 2.2.1 and 2.2.2 requires regular calibration of test apparatus and its correlation with measurements made by a competent authority.
- 2.2.4. In all cases the reference methods shall be those of this Regulation, particularly for the purpose of administrative verification and sampling.
- 2.3. Nature of sampling
- Samples of lamps shall be selected at random from the production of a uniform batch. A uniform batch means a set of lamps of the same type, defined according to the production methods of the manufacturer.
- The assessment shall in general cover series production from individual factories. However, a manufacturer may group together records concerning the same type from several factories, provided these operate under the same quality system and quality management.
- 2.4. Measured and recorded photometric and colorimetric characteristics
- The sampled lamp shall be subjected to photometric measurements for the minimum values at the points listed in Annex 3. and the required chromaticity coordinates.
- 2.5. Criteria governing acceptability

The manufacturer is responsible for carrying out a statistical study of the test results and for defining, in agreement with the competent authority, criteria governing the acceptability of his products in order to meet the requirements laid down for verification of conformity of products in paragraph 2.5.1 of this Regulation .

The criteria governing the acceptability shall be such that, with a confidence level of 95%, the minimum probability of passing a spot check in accordance with Annex 5 would be 0.95.



## Annex 5

### Minimum requirements for sampling by an inspector

1. General provisions
  - 1.1. The conformity requirements shall be considered satisfied from a mechanical and a geometric standpoint, in accordance with the requirements of this Regulation, if any, if the differences do not exceed inevitable manufacturing deviations.
  - 1.2. With respect to photometric performance, the conformity of mass-produced lamps shall not be contested if, when testing the photometric performances set forth in Paragraph 3.7 of this Regulation of any lamp chosen at random:
    - (a) No measured value deviates from the values prescribed in Paragraph 1.2.1. in Annex 4 .
    - (b) If, in the case of a lamp equipped with a replaceable light source and if results of the test described above do not meet the requirements, tests on lamps shall be repeated using another standard light source.
  - 1.3. Lamps with apparent defects are disregarded.
  - 1.4. The chromaticity coordinates shall be complied when tested under conditions of paragraph 4.7. of this Regulation.
2. First sampling

Four lamps are selected at random. The first sample of two is marked A, the second sample of two is marked B.

  - 2.1. The conformity of mass-produced lamps shall not be contested if the deviation of any specimen of samples A and B (all four lamps) is not more than 20 per cent.

In the case, that the deviation of both lamps of sample A is not more than 0 per cent the measurement can be terminated.
  - 2.2. The conformity of mass-produced lamps shall be contested if the deviation of at least one specimen of samples A or B is more than 20 per cent.

The manufacturer shall be requested to bring his production in line with the requirements and a repeated sampling according to paragraph 3 shall be carried out within two months' time after the notification. The samples A and B shall be retained by the Technical Service until the entire COP process is finished.
3. First repeated sampling

A sample of four lamps is selected at random from stock manufactured after alignment. The first sample of two is marked C, the second sample of two is marked D.

  - 3.1. The conformity of mass-produced lamps shall not be contested if the deviation of any specimen of samples C and D (all four lamps) is not more than 20 per cent.

In the case, that the deviation of both lamps of sample C is not more than 0 per cent the measurement can be terminated.

- 3.2. The conformity of mass-produced lamps shall be contested if the deviation of at least one specimen of samples C or D is:
- 3.2.1. More than 20 per cent but the deviation of all specimens of these samples is not more than 30 per cent.
- The manufacturer shall be requested again to bring his production in line with the requirements (alignment).
- A second repeated sampling according to paragraph 4 shall be carried out within two months' time after the notification. The samples C and D shall be retained by the Technical Service until the entire COP process is finished.
- 3.2.2. One specimen of samples C or D is more than 30 per cent. In this case the approval shall be withdrawn and paragraph 5 shall be applied.
4. Second repeated sampling
- A sample of four lamps is selected at random from stock manufactured after alignment. The first sample of two is marked E, the second sample of two is marked F.
- 4.1. The conformity of mass-produced lamps shall not be contested if the deviation of any specimen of samples E and F (all four lamps) is not more than 20 per cent. In the case, that the deviation of both lamps of sample E is not more than 0 per cent the measurement can be terminated.
- 4.2. The conformity of mass-produced lamps shall be contested if the deviation of at least one specimen of samples E or F is more than 20 per cent. In this case the approval shall be withdrawn and paragraph 5 shall be applied.
5. Approval withdrawn
- As required according to paragraphs 4.1. and 4.2., approval shall be withdrawn according to paragraph 3.7 of this Regulation.

---

## Annex 6

### Heat resistance test for rear fog lamps and daytime running lamps

- 1.1. The lamp shall be subjected to a one-hour test of continuous operation following a warm-up period of 20 minutes. The ambient temperature shall be  $23\text{ °C} \pm 5\text{ °C}$ . The light source used shall be a light source of the category specified for the lamp, and shall be supplied with a current at a voltage such that it gives the specified average power at the corresponding test voltage. However, for lamps equipped with non-replaceable light sources (filament light sources and other), the test shall be made with the light sources present in the lamp, in accordance with paragraph 3.7 of this Regulation.
- 1.2. Where only the maximum power is specified, the test shall be carried out by regulating the voltage to obtain a power equal to 90 per cent of the specified power. The specified average or maximum power referred to above shall in all cases be chosen from the voltage range of 6, 12 or 24 V at which it reaches the highest value; for lamps equipped with non-replaceable light sources the test conditions set in paragraph 3.7 of this Regulation shall be applied.
- 1.3. After the lamp has been stabilized at the ambient temperature, no distortion, deformation, cracking or colour modification shall be perceptible. In case of doubt the intensity of light shall be measured according to paragraph 4 of this Regulation. At that measurement the values shall reach at least 90 per cent of the values obtained before the heat resistance test on the same lamp.

## Annex 7

### ARRANGEMENT OF APPROVAL MARKS

The following approval mark arrangements are given merely as examples and any other arrangement made in accordance with paragraph 2.3 of this Regulation is acceptable.

#### 1. APPROVAL MARK OF A SINGLE LIGHT SIGNALLING LAMP

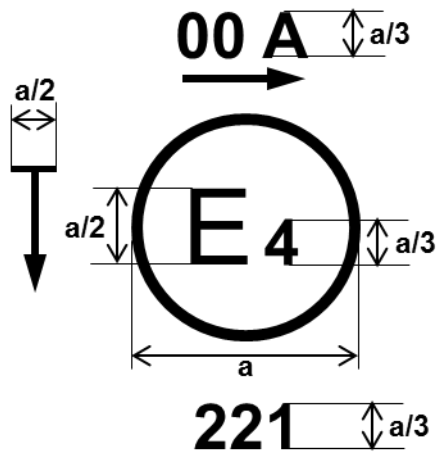

##### Example 1:

The lamp bearing the approval mark shown on the left is a front position lamp (A) approved in the Netherlands (E4), under approval number 221 pursuant to this Regulation.

The number (00) mentioned close to the symbol "A" indicates that approval was granted in accordance with the requirements of this Regulation as set in the original series of amendments. The horizontal arrow indicates the outwards of the vehicle. The vertical arrow starting from a horizontal segment and directed downwards indicates a lamp with reduced light distribution (vertically downwards and/or horizontally below the H plane).

$a \geq 5 \text{ mm}$



##### Example 2:

The lamp bearing the approval mark shown on the left is a rear direction indicator (category 2A) approved in France (E2), under approval number 3223 pursuant to this Regulation as set in the original series of amendments (00).

The additional letter "Y" indicates this direction indicator as being a part of an interdependent lamp system.

#### 2. APPROVAL MARK OF GROUPED, COMBINED OR RECIPROCALLY INCORPORATED LAMPS.

Note: The vertical and horizontal lines schematize the shape of the light-signalling lamp. These lines are not part of the approval mark.

##### Example 3:

	3333 IA 2b R2 00 00 00 E4			
	F2 AR S2 00 00 00			

IA 2b R2 00 00 00 F2 AR S2 00 00 00 3333 E4			

These examples of approval marks represent three possible solutions for the marking of a light signalling lamp where two or more lamps are part of the same assembly of grouped, combined or reciprocally incorporated lamps.

They indicate that the lamp was approved in the Netherlands (E4) under approval number 3333 and comprises:

- (a) A retro-reflector of class 1A approved in accordance with the 02 series of amendments;
- (b) A rear direction indicator lamp with variable luminous intensity (category 2b) approved in accordance with the 01 series of amendments;
- (c) A rear position lamp with variable luminous intensity (R2) approved in accordance with the 02 series of amendments;
- (d) A rear fog lamp with variable luminous intensity (F2) approved in accordance with the original version;
- (e) A reversing lamp (AR) approved in accordance with the original version;
- (f) A stop-lamp with variable luminous intensity (S2) approved in accordance with the 02 series of amendments.

3. APPROVAL MARK OF A LAMP WHERE THE LENS IS INTENDED TO BE USED IN DIFFERENT TYPES OF LAMPS.

Example 4:

**F1 2a AR R1 S1**  
**00 00 00 00 00**



**1432**

This example corresponds to the marking of a lens intended to be used in different types of light signalling lamps. The approval marks indicate that the lamp was approved in Spain (E9) under approval number 1432 and may comprise all listed different functions.

The main body of the lamp shall bear the only valid approval mark.

#### 4. IDENTIFICATION CODE OF LIGHT SOURCE MODULES

Example 5:

**MD E3 17325**

The light source module bearing the identification code shown above has been approved together with a lamp approved in Italy (E3) under approval number 17325.

---