

Proposal for a Supplement to the 01 series of amendments to Regulation No. 112 (Headlamps emitting an asymmetrical passing-beam)

The text reproduced below was prepared by the expert from Poland to replace a requirement 1000 lm for LED light source in headlamp which was vicariously introduced the Regulation to prevent very minimalistic performance of LED headlamps worse than base on H4 halogen. The modifications to the existing text of the Regulation are marked in bold for new or strikethrough for deleted characters.

I. Proposal

Paragraph 5.3.2.3., amend to read:

“5.3.2.3. The total objective luminous flux of all LED modules producing the principal passing beam and measured as described in paragraph 5. of Annex 10 shall be equal or greater than 1,000 lumens **when apply photometric requirements according p. 6.2.4. Above requirements (1,000 lumens) does not apply when illumination of headlamp equipped with LED light source(s) is tested according photometric requirements of p. 6.2.4.1. The choice of set of photometric requirements is left to applicant discretion.**

Add a new paragraph 6.2.4.1., to read:

6.2.4.1. The passing-beam equipped with LED light source(s) may alternatively meet the luminous intensities described as follows:

For right hand traffic luminous intensities at all points in the area described on the graph (Fig.1.) and in Tables 1. and 2. below should be equivalent to vertical illumination at the relevant distance at the road surface defined for direction parallel to headlamp optical axis. For left hand traffic all points and values should be mirrored with respect to X-X line.

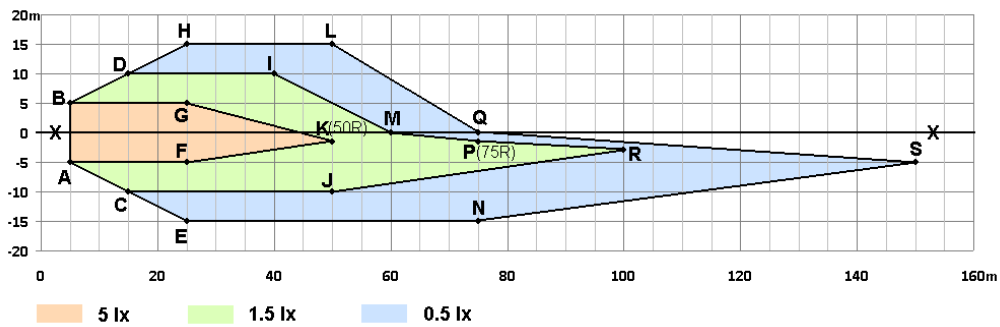

Fig 1. Vertical illumination at the road surface to be recalculated for luminous intensities for single headlamp. Side: + Left , -Right

For recalculation of the vertical illumination at the road surface to luminous intensities in angular system the position of optical centre of headlamp should be taken as 0.75 m above point 0,0 (Fig. 1.) of the road surface.

Cut-off shall be aimed one per cent (0.57 degrees) below the H-H line according p. 6.2.2. Measurements shall be done by standard photogoniometric equipment in spherical coordinate measuring system as described in Annex 3. Luminous intensities reflecting illumination of all the points in the Table 1 shall be measured.

Measurements should be done by standard photogoniometric equipment in spherical coordinate measuring system as described in Annex 3. Luminous intensities reflecting illumination of all the points (A to S) in the Table 2 shall be measured.

Table. 1. Co-ordinates of points limiting requirements for areas.

Point	Side position (m)	Beyond headlamp (m)	Height (m)
Headlamp centre	0	0	0.75
A	-5	5	0
B	5	5	0
C	-10	15	0
D	10	15	0
E	-15	25	0
F	-5	25	0
G	5	25	0
H	15	25	0
I	10	40	0
J	-10	50	0
K(50R)	-1.5	50	0
L	15	50	0
M	0	60	0
N	-15	75	0
P(75R)	-1.5	75	0
Q	0	75	0
R	-3	100	0
S	-5	150	0

Table.2. Required vertical illumination(lux) at the road surface

Area restricted by points	Minimum required value (lux)
A, F, K, G, B, A	5.0
A, C, J, R, P, M, I, D, B, G, K, F, A	1.5
C, E, N, S, Q, L, H, D, I, M, P, R, J, C	0.5

For reduction of quantity of measurements random procedure can be used which, however, provides reliable results and which cannot be influenced by anybody including technical service and applicant. The resolution of goniophotometer measurements should reflect similar and uniform density on whole equivalent road surface. At least one random measurement should be taken for farthest side from the lamp of each rectangle reflecting 1.0 m in width and 2.0m in length of road surface area. Any visible diversity on the vertical screen illuminated by headlamp should be additionally verified by measurements of darkest visible points and areas as well as for any other doubts.

Moreover the passing-beam shall meet the luminous intensities at the test points referred to in the tables 3 and 4 below and in Annex 3 Figure B (or mirrored about the VV line for left-hand traffic):

Table.3.

<i>Headlamps for RH Traffic**</i>							<i>LED Headlamp</i>
<i>Test point designation</i>		<i>Test point angular coordinates - Degrees</i>					<i>Required luminous intensity cd</i>
							<i>Max</i>
B 50 L		0.57U, 3.43L					350
BR		1.0 U, 2.5R					1,750
75 L		0.57D, 3.43L					10,600
50 L		0.86D, 3.43L					13,200***
Any point in zone III (bounded by the following coordinates in degrees)							625
8 L	8 L	8 R	8 R	6 R	1.5 R	V-V	
1 U	4 U	4 U	2 U	1.5 U	1.5 U	H-H	
Any point in zone I (1.72D to 4D, 9 L to 9 R)							< 2I*

Note: In the table:

Letter L means that the point is located on the left of VV line.

Letter R means that the point is located on the right of VV line.

Letter U means the point is located above HH line

Letter D means the point or segment is located below HH line

* Actual measured value at points 50R / 50L respectively

** For left-hand traffic, the letter R shall be replaced by letter L and vice versa.

*** In case where a headlamp in which LED modules are producing a passing-beam in conjunction with an electronic light source control gear, the measured value shall not be more than 18,500 cd.

Table.4.

<i>Headlamps for RH Traffic**</i>		
<i>Test point</i>	<i>Angular coordinates Degrees</i>	<i>Required luminous intensity- cd Min</i>
1	4U, 8L	Points 1+2+3 190
2	4U, 0	
3	4U, 8R	
4	2U, 4L	Points 4+5+6 375
5	2U, 0	
6	2U, 4R	
7	0, 8L	65
8	0, 4L	125

II. Justification

1000 lm luminous flux required for LED modules is substitute to flux required for halogen light sources (Reg. 37) used in passing beam headlamps. From one side such requirement does not guarantee good road illumination because it depend on optical design of headlamp and light distribution which for LED can significantly differ from incandescent lamp. From the other side with 1000lm requirement there is no motivation to use effective optical LED designs which can allow for better road illumination with less luminous flux and energy saving.

Present minimum photometric requirements for halogen passing beam headlamps require very basic road illumination (compare Fig. 1.). The key point is that it is possible to fulfill minimum photometric requirements of present Reg. No 112 by LED's with significantly less flux than 1000lm.

Most of contemporary halogen headlamps allow to significant better road illumination than minimum one. In such situation **removing flux** criterion for LED's **without appropriate additional criterion** could cause **significant deterioration** of road illumination in far distances and road traffic safety because it will lead to optimization of production costs not the lamp performance.

This is internal weakness of present photometric requirements (Reg. No 112 and the other). Moreover the luminous flux in any form cannot be appropriate parameter to guarantee proper road illumination from the basic reasons (e.g. as proposed in French document ECE/TRANS/WP.29/GRE/2015/22). It is because very detailed flux distribution (not only the value) is responsible for road illumination and safety. Therefore neither lux value at the vertical screen nor cd intensity in angular system will guarantee good illumination. The best way to verify quality of road illumination is to describe it by **vertical illumination (lux) at the road surface**. This way of presentation **is commonly used** from many years by manufacturers and laboratories to compare beam patterns. Also CIE advice use this road isolux lines for headlights assessment. Moreover it is clear "performance" description

independent on headlamp design, light source etc. It can be very simple and easy reversely recalculated to the vertical screen and subsequently to photo-goniometric angular system.

As a base to prepare above photometric requirements there were used results of halogen headlamps measurements which were also base for CIE S 021/E:2011 assessment standard. Below are presented plots of road surface vertical illumination isolux lines of halogen headlamps used to prepare TC4-45 standard:

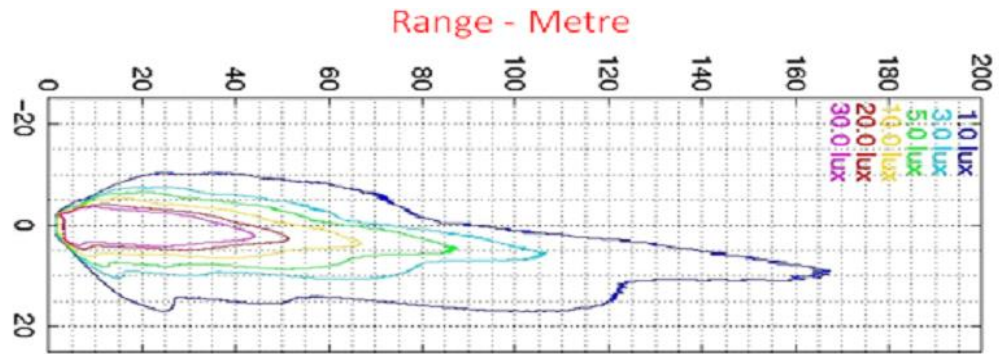

Headlamp System 1

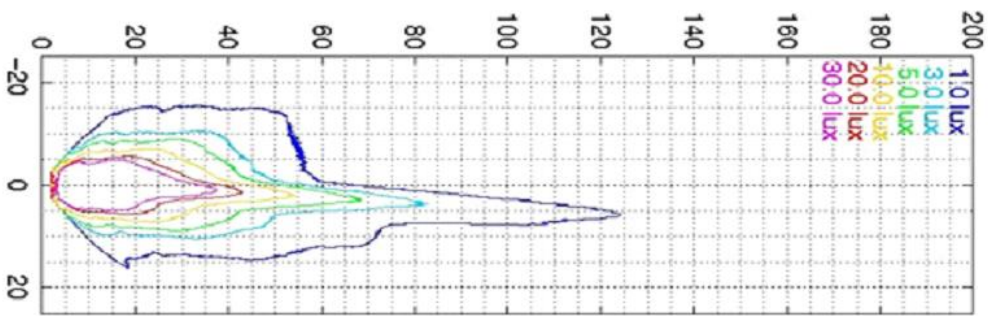

Headlamp System 2

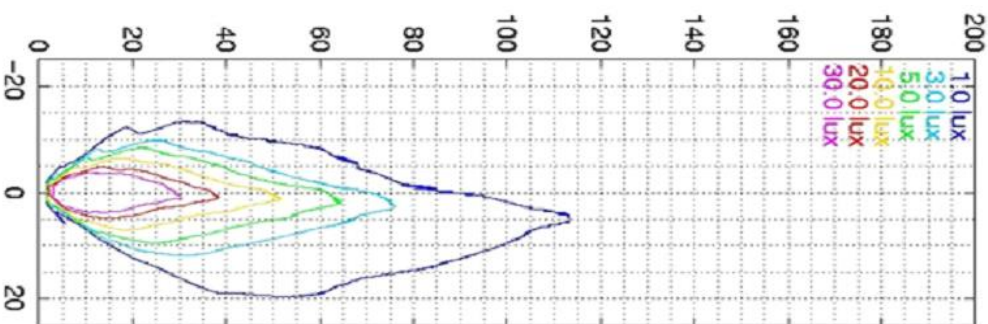

Headlamp System 4

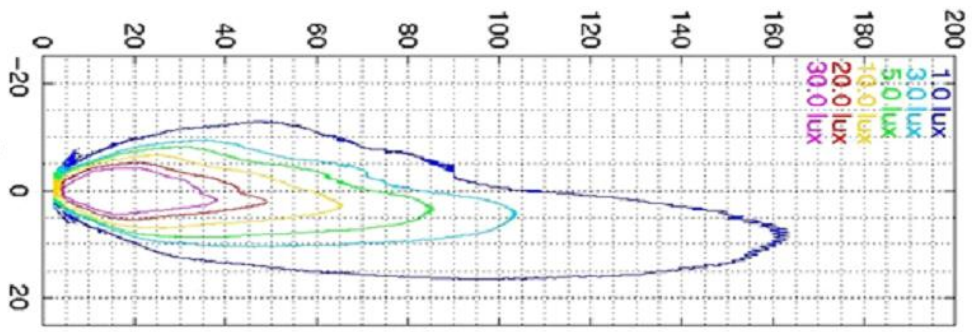

Headlamp System 8

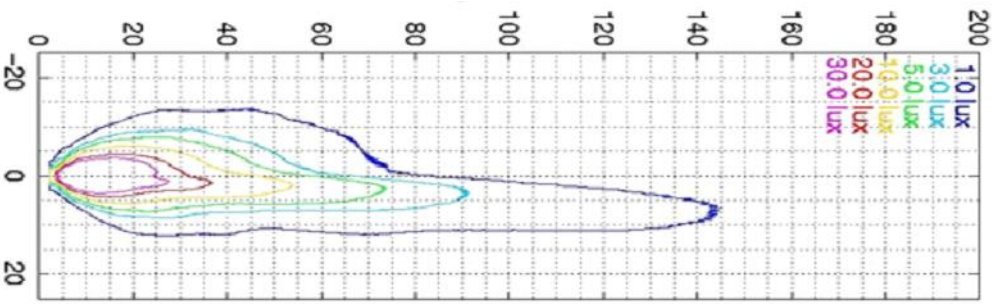

Headlamp System 9

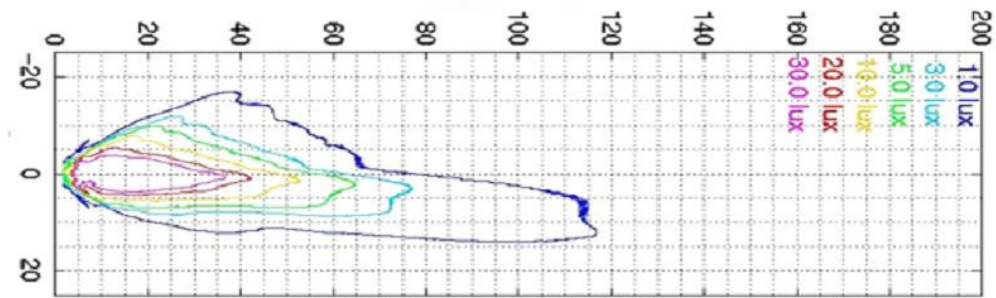

Headlamp System 13

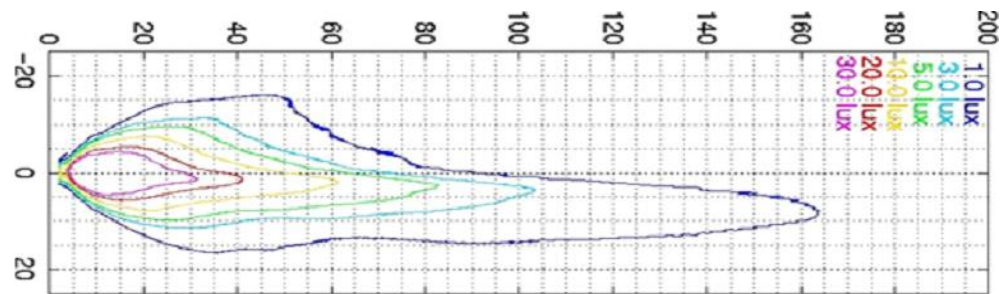

Headlamp System 14

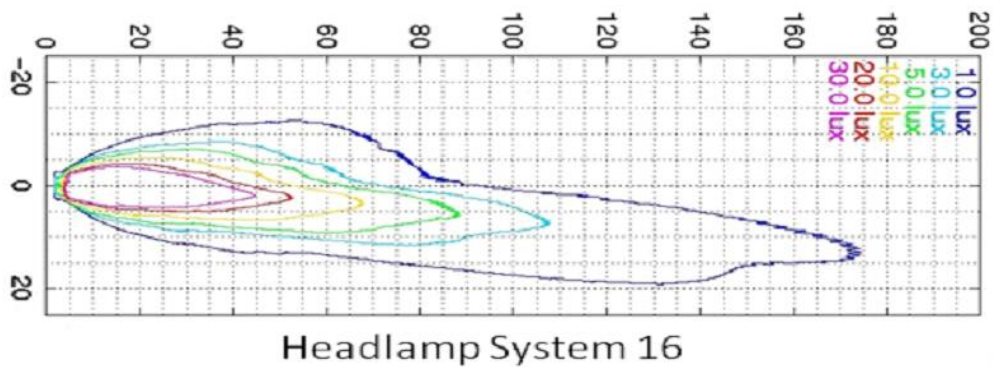

At the Fig. 1. is shown area at the road surface where requirements are defined according Reg. 112 (see GRE 72-24).

“A”

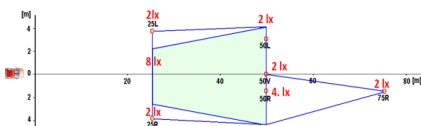

“B”

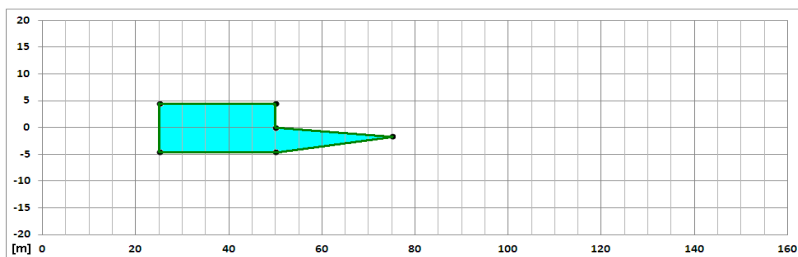

Fig. 1 Presently required illuminated area according Reg. 112 (GRE 72-24) for reference. Distances at “B” are comparable to plots above.

It is easy to see that area and values required by Reg. No 112 are much lower and at smaller area than contemporary halogen headlamps possibilities. Because of safety reasons there is reasonable to require at least **similar to halogen level of road illumination by LED headlamps**. Especially because in common understanding LED technology is better than HID. For today it is unfortunately not general truth.

Based on above examples of real headlamps and take into account CIE standard expectations regarding range and width it is proposed to define requirements according Fig. 2. below.

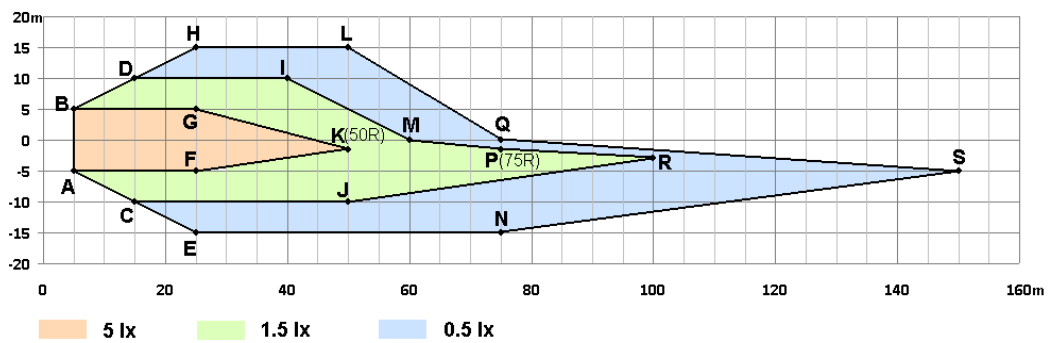

Fig. 2. Proposed areas and vertical illumination at road surface.(For two headlamps on the vehicle values **will be doubled**).

It represent reasonable good (not the highest) level of contemporary halogen headlamp performance. When comparing above real examples and the lux values of proposal (Fig. 2.) **proposed values shall be multiplied by two** because requirements are described for single headlamp when in the vehicle pair of headlamp is installed.

The proposed lux values follows CIE standard: 1lx and 3lx for “range” and “width” and 10 lx for central and foreground area.

On Fig. 3 is shown present required area on the background of the proposed. It easy to see the difference between contemporary “halogen level” and suggested by other proposals “minimum LED level”. If will be **removed 1000lm LED requirement** from Reg.112 without any additional road illumination requirements the **range will be decreased 2 times and width 3 times** comparing present average road situation.

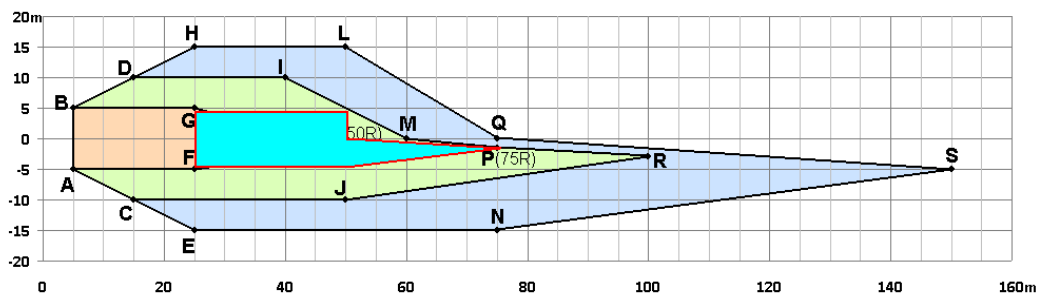

Fig. 3. Present requirements on the background of proposed.

In addition proposed changes will help to solve “unsolvable” **beam [pattern homogeneity] problem** because optimizing of flux will lead to uniform light distribution on the road.

If LED headlamp will illuminate the road as above or better there **will be no need to require minimum value of luminous flux**.

Practically it is possible easily to obtain above (Fig.2.) values by effective LED headlamp design with light source flux less than 500 lm.

ADVANTAGES OF PROPOSAL

The most important is **voluntariness of choice**:

- Manufacturers who prefer testing LED headlamps as before can do it but still will be obliged to provide 1000 lm light source flux.
- Manufacturers who prefer produce effective LED headlamps but with restricted flux will have freedom to do it but they will be obliged to guarantee at least **contemporary halogen quality** level.

This way of introducing new requirements will show after some time preferences and motivation of manufacturers. They **will have choice, time and freedom** to test and accept the new solution without the need for transitional provisions and rapid technology changes or production conditions. If will be interest in new more free and “performance oriented” way it will open the way to **simplification of other headlamps regulation**.

Proposal should restrict access to the market **very cheap and poor** aftermarket LED headlamps what is **beneficial for industry and for road traffic safety**.

TECHNICAL SERVICE EXPLANATIONS

Proposed way of defining requirements **does not make significant difference** during laboratory measurements. Fig. 4. shows the relations.

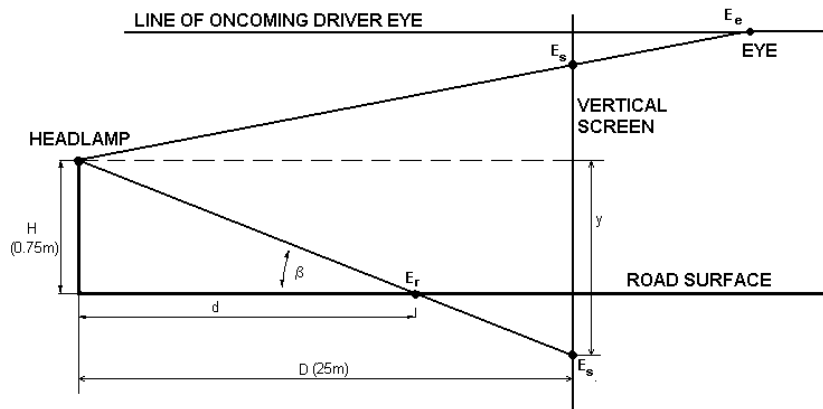

Fig. 4. Relations between screen and road requirements.

There is no need to describe values on the screen. They can be simply recalculated according formula:

$$E_e = E_r \cdot d^2 / 625$$

Where:

E_s - equivalent screen illumination in [lx]

E_r - required road illumination in [lx]

d - distance on the road in front of the vehicle in [m]

Vertical position on the screen y equivalent to road distance d can be calculated:

$$y = -0.75 \cdot 25/d = -18.75/d$$

Plot of this equation is presented on Fig. 5.

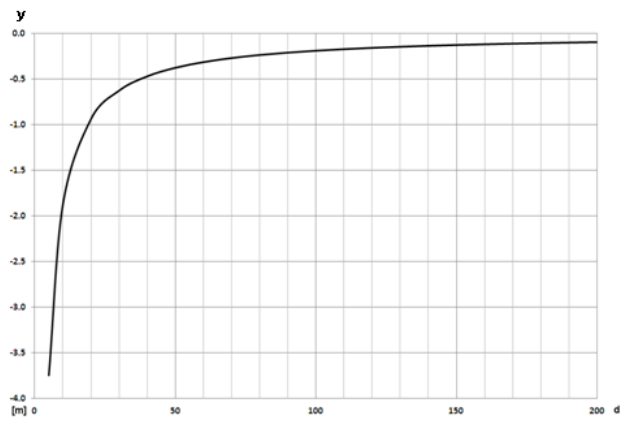

Fig 5. Road distance in front of the vehicle d translated to vertical position V at the 25m screen.

Below on Fig. 6. to 8. are presented plots of relation between screen vertical position and illumination for the proposed three road areas.

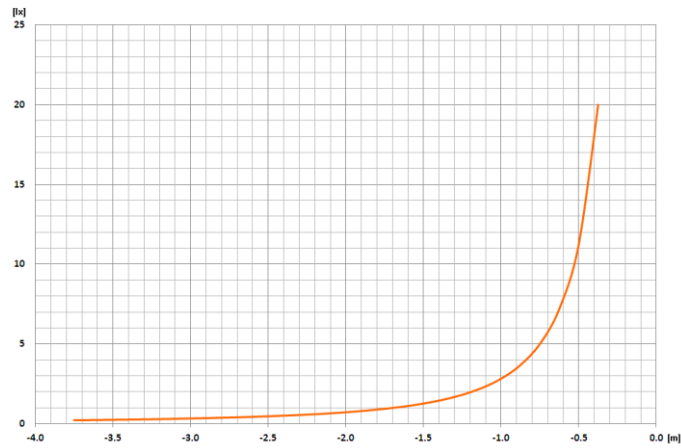

Fig. 6. The 5 lx road area converted to illumination at the screen vertical position.

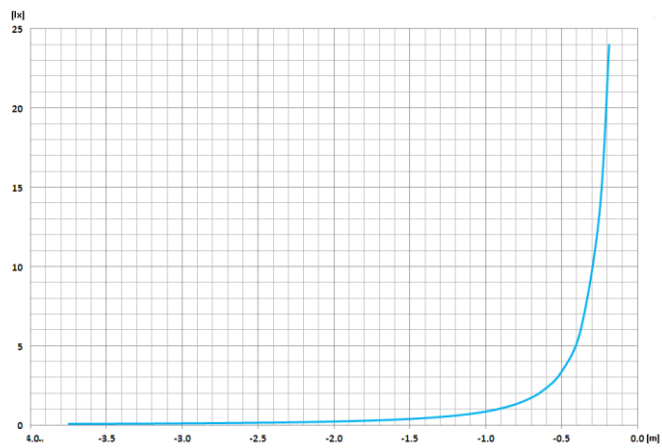

Fig 7. 1.5 lx road area converted to illumination at the screen vertical position.

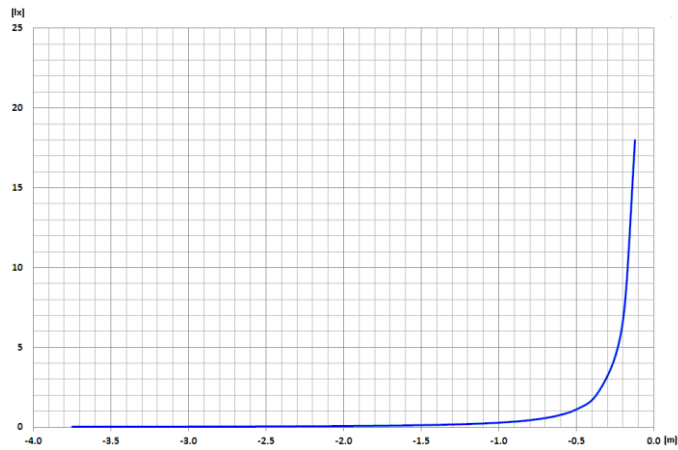

Fig 8. 0.5 lx road area converted to illumination at the screen vertical position.

All above presented graphs are **highly nonlinear**. It is the explanation why **present requirements for the screen areas make troubles** with flux, light sources, homogeneity etc.

Above graphs and formulas explain how to translate road lux requirements to screen and then to photogoniometer angular system.

It is not technical problem because all contemporary photogoniometer are computerized and all this recalculation will be done automatically without problem to technical service. Presently to find max. or min. intensity in areas high density scanning is required which is time consuming.

In proposed situation it is possible to use random measurements which significantly reduce time needed for measurements. Moreover the density of measurements is related to the road not the screen allowing for better matching light to the driver needs.