

Submitted by the expert from Hungary

Informal document GRSG-103-02  
103<sup>rd</sup> GRSG, 2-5 October 2012  
Agenda item: 2

**Background information to the problems of emergency exits  
and ejection of passengers in buses**

This document is a FISITA paper which will be presented in November, at the FISITA 2012 Congress in Beijing. It is sent to GRSG, not for direct discussion, but rather providing background information and justification to the discussion of the two other informal documents GRSG-103-03 and GRSG-103-04, dealing with the subjects, mentioned in the title.

## **PASSENGER'S EJECTION IN BUS ROLLOVER ACCIDENT**

Dr Matolcsy Mátyás  
GTE, Hungary

**KEY WORDS:**

bus, rollover, ejection, safety belt, emergency window

**ABSTRACT**

The rollover is the most severe, dangerous bus accident. If the weak superstructure collapses in the rollover, the passengers are compressed and killed, or seriously injured. Requiring specified roof strength - UN-ECE. Regulation 66. - the severity of bus rollovers were significantly reduced. Later it became clear that another problem – belonging to the rollover accidents, too – the ejection of the passengers from the bus remained unsolved. Some case studies and statistical data are shown in the paper to present the ejection. Two kinds of ejections exist: the total ejection, when the passenger gets out completely from the passenger compartment, and the partial ejection, when only the head, shoulder, chest, arms, and the lower parts of the body remain inside. The injury mechanisms are discussed in the paper. The reason of the ejection is the broken side window. It is not allowed to use laminated safety glass as side window, because the side windows are generally used as emergency exits. The paper proves that the side windows are not needed as emergency exit and the breakable side windows are absolutely unusable as emergency exit. Nowadays it is hoped that the retention of the passengers may be solved by the obligatory use of safety belts. The paper shows that this assumption is faulty; the safety belts have more disadvantages than advantages in rollover. When the bus is lying on its side after a rollover accident, and the passengers are wearing their safety belt, they are hanging in a very unusual position and they cannot release the loaded safety belts. On the other hand, the safety belt can prevent the projection and total ejection, but it is almost ineffective against the partial ejection. In the UN-ECE organization there are different efforts – the author is participating in this work – to solve this problem, but there is no one good solution, because the problem is very complex (obligatory use of safety belts, laminated safety glazing, emergency exits, etc). The paper tries to give a clear picture about the problem – which is an essential, newly recognized issue in the bus safety – and showing the possible ways to the solution.

**INTRODUCTION**

In the mid '70-s the bus rollover became known as a very dangerous accident. It may be said that this time it was known as the most severe bus accident. Because of the generally weak superstructures endured large scale plastic deformations or in many cases completely collapsed, so the passengers were compressed, or hard structural elements intruded into their bodies. Typical results of rollover accidents are shown on Figure 1. proving that the way of large scale deformation is general and similar – when the superstructure is weak – in small and large buses, double deckers. The fatality rate was very high in these accidents (30-50% of the passengers being on the board in the accident). International legislative – and belonging research – work was initiated in UN-ECE (Geneva) which resulted in 1986 the Regulation 66. which required a certain roof strength for Class II and Class III coaches. This regulation was improved and developed in 2004 and now it may be said that the roof strength problem of buses is solved. The coaches, which are approved on the basis of Reg.66. do not collapse in a

wide variety of rollover accidents (excluding of course, when the bus is rolling and falling down into a deep, e.g. 20 m or more precipice).



Figure 1. Collapsed superstructures in bus rollover

A brief history of the international activity about rollover protection is given as follows:

- 1974 Hungary raised the problem in Geneva, urged international regulation. The proposal was refused.
- 1976 UK joined to the Hungarian proposal, international work (study, data collection, research, rollover tests) has been started. Germany, Sweden also joined to the action.
- 1986 UN-ECE Regulation 66 – about the required strength of the bus superstructure – has been accepted and put into force.
- 2005 The revised, developed version of R.66 has been finished, it became clear – on the basis of accident analysis – that it is a very effective tool to provide „survival space” for the passengers in protectable rollover accidents (PRA) and to reduce drastically the fatality rate.
- 2000 It was recognized that the second most dangerous injury mechanism is the ejection, projection of the passengers

#### INJURY MECHANISMS IN ROLLOVER

At the beginning – as it was said above – only the intrusion was known and it was thought that all the fatalities and injuries were due to the compression of the passengers. Later more injury mechanism came into the picture. First the differentiation between the causes of the injuries, next the parts of the human body on which the injury happens (e.g. head, neck, thorax, extremities, etc.), and finally the medical form of the injuries (fracture, contusion, distortion, laceration, cut, nerve damage, etc.)

On the basis of the different causes, the following injury mechanisms are considered today:

- Intrusion means that the strongly deformed superstructure – more exactly parts of the superstructure – intrudes into the body of the passenger, compresses, crushes parts of the body (head, chest, pelvis, etc.) This injury mechanism is the most dangerous in rollover, but it can be avoided by a strong superstructure. (see UN-ECE Reg.66)
- Projection means that – without using restraint system – the passenger leaves the original (seating) position due to an uncontrolled, unwanted motion, “flies” in the passenger compartment or sometimes out of it. During this motion hits rigid, hard parts of the compartment, or bumps against other “flying” passengers, or hits the outside ground when leaving the bus through a broken window. It was thought that the best tool against projection is the compulsory use of safety belt. It is partly true, the problems will be discussed later.
- Ejection means that the passenger – totally or partly – comes out from the passenger compartment, out from the outside contour of the bus through the broken side windows. At the beginning the total and partial ejection were handled together, but later it became clear that they are completely different events, motions, mechanism:

- Total ejection could be fortunately, if the bus rolls away from the ejected passenger, or tragic, if the bus rolls onto the passenger. The complete ejection could be prevented by the use of safety belt.
- Partial ejection is always dangerous, could cause very severe injury (even fatality) and the safety belt is generally ineffective against it. Only the upper parts of the body (head, shoulder, chest, arms) come outside the bus.

The ejection and projection are – in many cases – overlapping processes, depending on the status of the side windows. If they are not broken, they can keep the passengers inside the bus, if broken, the projection can be ejection.

- Gash, prick (on the passenger body) means a special injury, caused by the broken glass pieces, fragments. The glass fragments can fall onto the passenger, or – if the bus turns on its side only – onto the ground and the passenger (being partially ejected) is injured by the ground and the glass fragments together. This injury is very dangerous, if the bus is sliding further on its side after the turn over. The good solution against this kind of injury would be the use of laminated safety glass in side windows, instead of the toughened glass generally used for the time being.
- Burning means a “fire caused” injury, if the bus gets fire after rollover (as consequence of the rollover). Fire tests of buses proved [12] that – depending on the type, the propagation of the fire and other circumstances – the available evacuation time for the passengers is in the range of 3-5 minutes.

This brief list shows that there are certain overlaps among the injury mechanisms and there is no one technical solution which could prevent, or at least significantly reduce the injuries in all cases. Or in other words: no one solution having more advantages than disadvantages in all causes.

## ACCIDENT ANALYSIS

At the beginning, when the collection of information about bus rollover accidents was started, first general statistics was collected: bus categories, types of rollover, number of casualties, etc. were only considered. At that time the methods of “case study” and “in-depth accident analysis” were not known and used methods and if some information appeared about the ejection, it did not produce interest. Later on some accident reports called the attention to the problem of passenger ejection. First the total ejection came into the picture, later the partial ejection, too. At the beginning there were no detailed information about other injury mechanisms, only the intrusion into the passengers by the roof. The other injury mechanisms were recognised around the turn of the century and the ejection problem became interesting and discussed. At that time more detailed researches, accident analysis were initiated, e.g. ECBOS project producing working documents, publications [5], and Final Report [6] and a discussion was started in UN-ECE/WP.29/GRSG about the problem of passenger’s ejection in bus rollover accidents. To prevent the ejection, different solutions were offered and discussed – inside the frame of UN-ECE organisation and outside as well – but for the moment there is no final, accepted, regulated method. Although to solve the roof strength problem was hard task and took a long time (around 10 years), the ejection question is more complex and therefore also time-consumer. The fortune is that the ejection does not cause so high fatality rate, but it is the second most dangerous injury mechanism.

### In-depth accident analysis

Some in-depth accident analyses are listed below, giving examples about the passenger ejection.

***Rollover accident in Egypt [1]*** A HD coach (Class III.) – taking a curve with relative high speed – rolled over with 50 Hungarian tourist on board, turned on its left side, slid 30-50 m away and stopped. The superstructure was strong enough, no significant structural deforma-

tion. All the side windows were broken (see Figure 2.), the casualties were caused by the ejection of passengers, mainly partial ejection. The passengers fell onto the left side of the bus, compressing the people sitting next to the windows, through the broken windows to the concrete road surface and they were rasped by the glass fragments and by the road. The result: 11 fatalities, 29 injured and hospitalized persons, among which 4 were in life danger and 15 seriously injured.



Figure 2. The bus turned on its side and slid away (Egypt)

**Rollover in Switzerland** [2] A tourist coach (Class III) - 24 passengers and 2 drivers on board – rolled down from a mountain road. The path of the rolling process is shown on Figure 2/a. The first part was a slight slope, on which the bus had 6-7 rotations, during which the superstructure completely collapsed. Finally the bus fell into the precipice. The result was: 12 fatalities, 15 serious injuries (4 of them in life danger). During the first period of the rollover 21 persons were ejected, 7 of them were dead. (see Figure 3.b and c.) The remaining 5 persons were not ejected during the drastic fall, and one of them survived the whole process (in life danger)

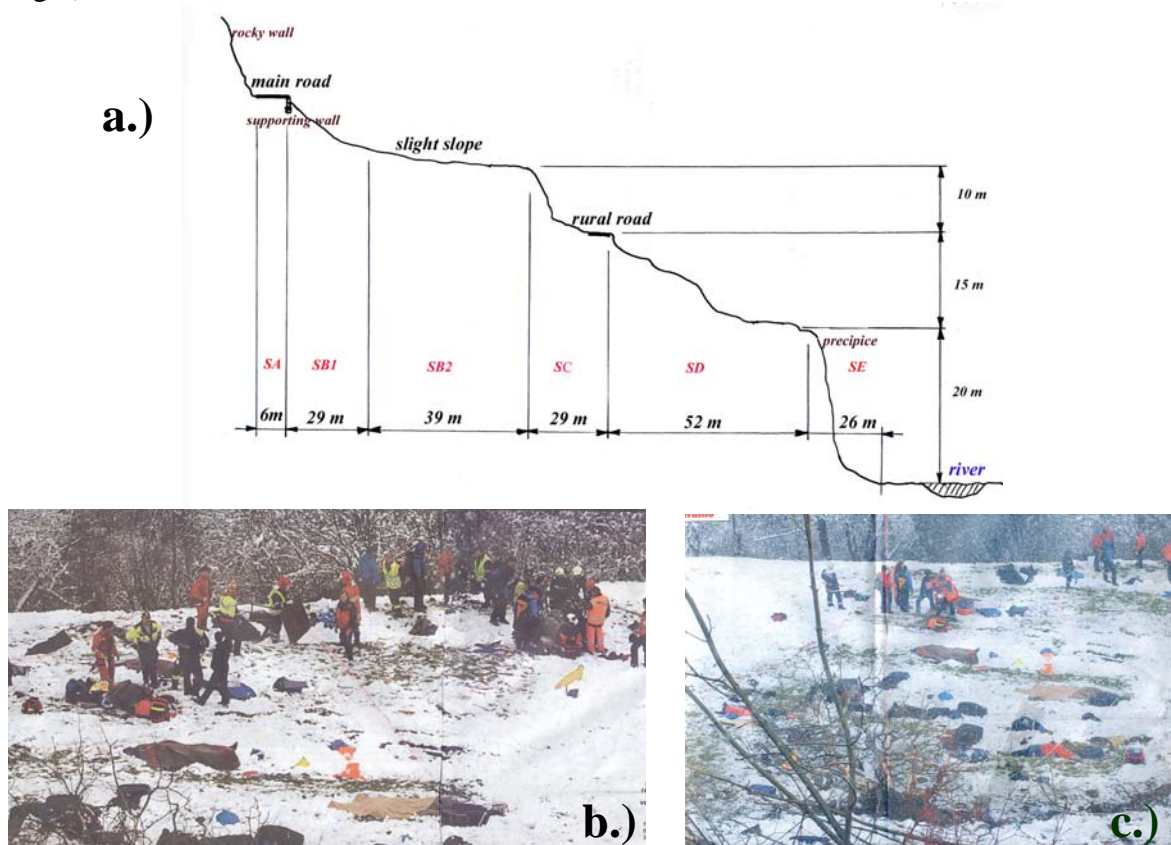

Figure 3. The path of the rolling process (Switzerland)

**Rollover accident in Hungary** [3] The driver of an intercity coach (Class II.) on an icy, snowy road lost the control, the coach slipped in a sharp curve and rolled down on a snowy slope with 2 ¼ rotations and stopped on its side. 15 passengers on board, plus driver. The superstructure was strong enough, no significant deformations. The windscreen and the majority of the windows were fallen out without breaking (installation with rubber profiles). The slope and the bus – after the accident – is shown on Figure 4. The result: 8 serious injuries, 8 light, but 7 of them were hospitalized. 3 persons (among them the driver) were totally, 3 passengers partially ejected. They were partially under the bus, getting very severe injuries. It took more than one hour for the firemen to escape them. They were ejected in the second round. It is interesting to note that the passengers – even the rollover was a relative slow process – could not describe the process, their motion. They estimated 2- 2,5- 3 and also 4 rotations.

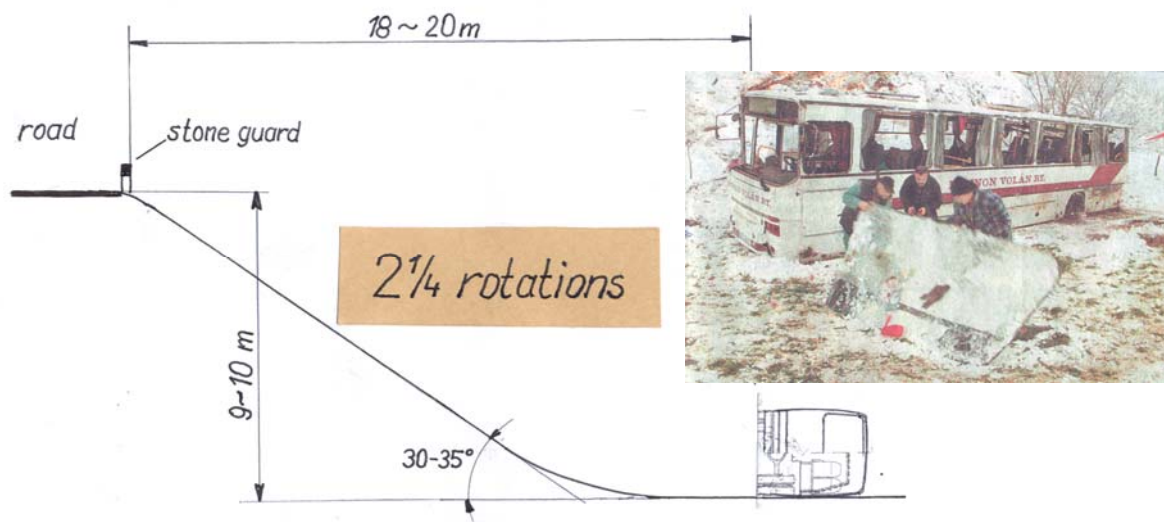

Figure 4. Rollover on a slope with 2 ¼ rotations

### Statistics

Information were collected about more than 460 bus rollover accidents [4]. It is rather difficult to find out from accident reports whether the bus was approved or not according to Regulation 66. But it is easy to recognize whether the required passenger survival space was harmed or not (partially or completely) by the deformed superstructure. Table I. compares the casualty rates for different samples of rollover accidents. The casualty rates mean – in this case – the average (fatalities, injuries) value in one accident, belonging to the sample:

$$\text{Casualty Rate (R}_c\text{)} = \frac{\text{Number of casualties in the sample}}{\text{Sample size}} = \frac{N_c}{n}$$

Statistical sample means certain group of (rollover) accidents, in which certain feature, characteristics is common (Protectable Rollovers, or at least one fatality is involved, or all rollovers, etc.) Protectable rollover accident (PRA) is, in which the occupants could be protected [7] (Counterexample: to roll down into a 100 m deep precipice is not a PRA). Among the casualty rates we can specify fatality rate, serious injury, all injury rate, etc. It is interesting to compare the two fatality rates (see Table 1.): when the survival space was harmed, or it remained intact. The ratio between them is more than 13:1; more than one order.

Considered accidents (statistical sample)	Number of events (sample size)	Casualty per accident (CR)				
		Fatality	Serious injury	Slight injury	Injury with- out classifi- cation	All casual- ties
All rollover accidents	462	11,7	3,1	3,1	7,6	25,5
Protectable rollover accidents (PRA)	278	5,7	2,8	3,6	6,3	18,4
Survival space unharmed	131	1,0	2,1	4,3	5,4	12,8
Survival space damaged	78	13,6	6,8	4,0	10,2	34,6
Bus fire after rollover	15	26,0	3,8	1,6	8,2	39,6

Table I. Casualty rates in different rollover samples

It is difficult to get a clear picture about the weight of the ejection in rollover accidents. Earlier the ejection was not important, interesting issue, and later on, when it became interesting, the competent people on the scene of the accident (policemen, ambulance people, firemen) are not expert in this subject and generally they have their own, urgent task after the accident. They do not care too much about ejection. But slowly the interest turns to this problem and more and more reports contain notices about ejections. In the last two years 91 rollover accident information was collected, among which in 9 cases (10%) the ejection was mentioned. It may be assumed that ejection happens in 15 ~ 20% of the rollover accidents.

Lessons, learned from bus rollover tests.

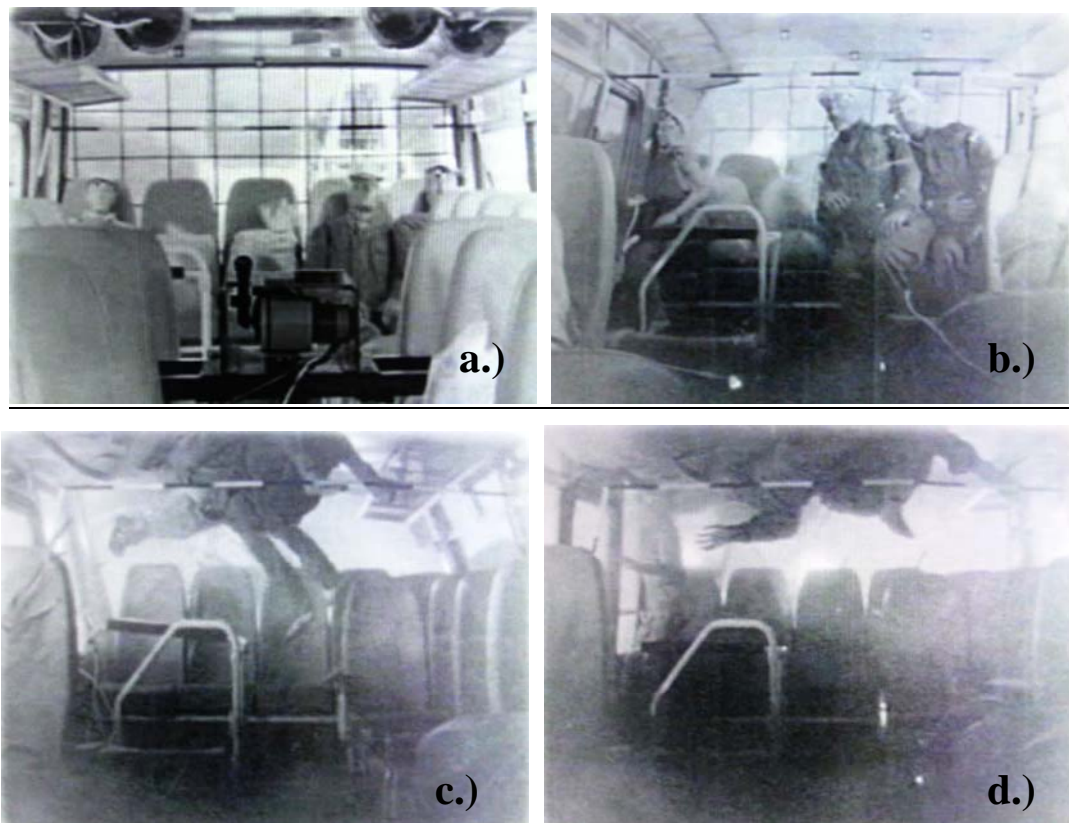

Figure 5. Motion of unbelted dummies in a rollover test

In the mid of the '70-s IKARUS made a lot of different rollover and roof strength tests [7]. Rollover tests on a standard 6/4 slope were carried out to study the energy input and energy absorption by the superstructure. In the test with loaded bus all the seats were loaded by a

sandbags (68 kg), fixed by ropes to the seats. Many sandbags were “ejected” during 1,5 rotation, they were scattered on the slope, and the ejection process could be seen on the high-speed film. But our conclusion was – when evaluating the test – that the mass and the inertia of the rolling bus could be changing during the process and we did not recognize it as a dangerous injury mechanism, because the ejection problem was not recognized at that time, as a dangerous injury mechanism. Later on, another similar rollover test was performed with dummies. Three dummies were used – without seatbelt – and filmed. Figure 5./a shows their original position sitting on the rearmost seat row, 5/b when two of them are leaving their seats but still in “seating” position, while 5/c and 5/d in “flying” position. During this motion they hit the roof structure, the windows on both sides and bump each other. The superstructure was strong enough, the side windows did not break, therefore the dummies were not ejected. The evaluation of this process gave good arguments to the international discussion: how to consider the effect of the unbelted, or belted passengers in the rollover, related to the energy input. [8] Again, at that time we did not consider the „projection” and “ejection” as injury mechanism just an effect on the energy input, energy balance. Twenty years later an interesting rollover test was produced by VOLVO [9]. Eleven dummies, representing children and adult passengers, using 3 pts safety belt, were used in this test. (Two of them were not belted). This test proved that the 3 pts safety belts are effective against projection, because they kept the dummies on them seats after 3 ¼ rotations. The unbelted dummies were flying around the passengers compartment.

#### HOW TO PREVENT EJECTION?

Recognizing the serious problem of passenger ejection, generally six feasible possibilities are mentioned [10]:

- a) To design and use **small side** windows which geometrically prevents the ejection. Small reduction in window’s dimension does not help, large reduction (see airplane windows) is unacceptable for the passengers, bus operators and manufacturers as well.
- b) To provide **high side wall** under the window rail (900~1000 mm) in the passenger compartment. This is shoulder height of a sitting passenger related to the floor level under the seat.
- c) To use **horizontal rails** (hand straps) at the side windows, at shoulder height of the sitting passengers. It was thought that this rail could prevent the partial ejection, but seeing the unbelted dummy’s motion in the rollover (Figure 5.), it was obviously not true. Later on it was supposed that these rails, together with safety belt could be a good solution. But the question is, whether the safety belt is an effective tool against ejection?
- d) To use **laminated glazing** in side windows. The laminated glazing is widely used as windscreen and it proved that if there is no large scale structural (plastic) deformation, it could be cracked, but never breaks and falls out from its frame. In the discussions – mainly from the bus manufacturers – a lot of arguments were listed against this solution:
  - it is more expensive than the toughened safety glass. It is true, but it was true when this technology was introduced at windscreens. To increase the safety has a price in any cases.
  - the weight of laminated glass is bigger than the toughened glass. (This is not an a priori truth)
  - using laminated glassing, the side windows can not be used as breakable emergency exit and this significantly decreases the safety.



- e) Obligatory use of **safety belt** is the most popular idea nowadays. (Safety belt was developed to prevent projection in frontal collision). It was thought that it could prevent the projection and ejection, both the total and partial ejection. Both 2 pts belts and 3 pts belts were considered (examples taken from cars and airplanes), but the 3 pts belt does not have reality in buses as general solution. (The driver's seat may be equipped with 3 pts belt). Generally there were two objections against the safety belt:
- It is impossible to force the passengers to use it during the whole journey. In contradiction to the airplane, where the use of the safety belt is obligatory only at take off and landing, so during the flight it can be released. It is not comfortable to be belted during a long trip, for 4-5 hours.
  - The standing passengers (see Class II. coaches) cannot be belted and their uncontrolled motion strongly influences the position of the sitting passengers as well.
- f) To use side airbags which could „replace” the broken side windows [10]. The referred example is the side airbag in cars.

Concentrating on prevention of ejection (both total and partial), solution “a” from technical point of view is a good one, but unacceptable for the passengers, operator and manufacturers. Solution “b” and “c” are not sufficient, they cannot prevent the ejection. Solution “f” is more theoretical than practical nowadays. Up to present the safety belt was preferred as reassuring solution. But the laminated glassing should not be neglected, as well.

On the basis of the above said an important conclusion may be drawn: there is no one, only one technical solution against ejection.

#### SUPPLEMENT TO THE SAFETY BELT ISSUE.

The safety belts (both the 2 pts and 3 pts belts) are very effective tools to keep the passengers in their seats – in their survival space – in frontal collision. To prepare a future test series, preliminary tests were performed in Jáfi-AUTÓKUT Research Institute (Hungary) comparing the effect of 2 pts and 3 pts belts with Hybrid III 50% male dummy and also with human body. A coach seat was built into a strong frame which was tilted sideways (both quasi-static and dynamic turn over). Figure 6. shows the arrangement.

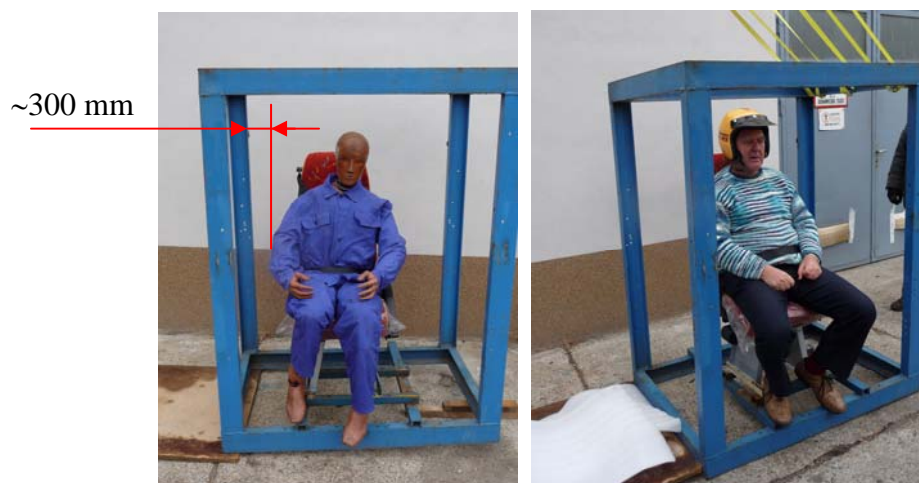

Figure 6. Tilting tests with seatbelt

The coach seat was fixed to a strong, steel frame, far away from the theoretical bus side wall with ~ 300 mm, to avoid any kind of damage of the dummy. Quasi static and dynamic tilting

tests were performed, having 90° degrees rotation. Figure 7. tries to summarise the main conclusions:

- a) The passenger – using 2 pts belt – can not sit on the seat without massive grasping at tilting of  $\alpha = 20^\circ$ . At  $\alpha = 25^\circ$  it is impossible to remain inside the passenger compartment and at  $\alpha = 30^\circ$  the passenger can not control his position, he is partially ejected.
- b) The dummy with 2 pts belt has certain inclination in the three given tilting position, but much less than the human body. After the dynamic tilting the dummy hit its head to the ground, which was not in the real position, real distance from the seat (see Figure 9.)
- c) The dummy with 3 pts belt had smaller inclinations than the dummy with 2 pts belt and after the dynamic tilting its head did not contact the ground. The dummy was completely hanging on the seat belt.

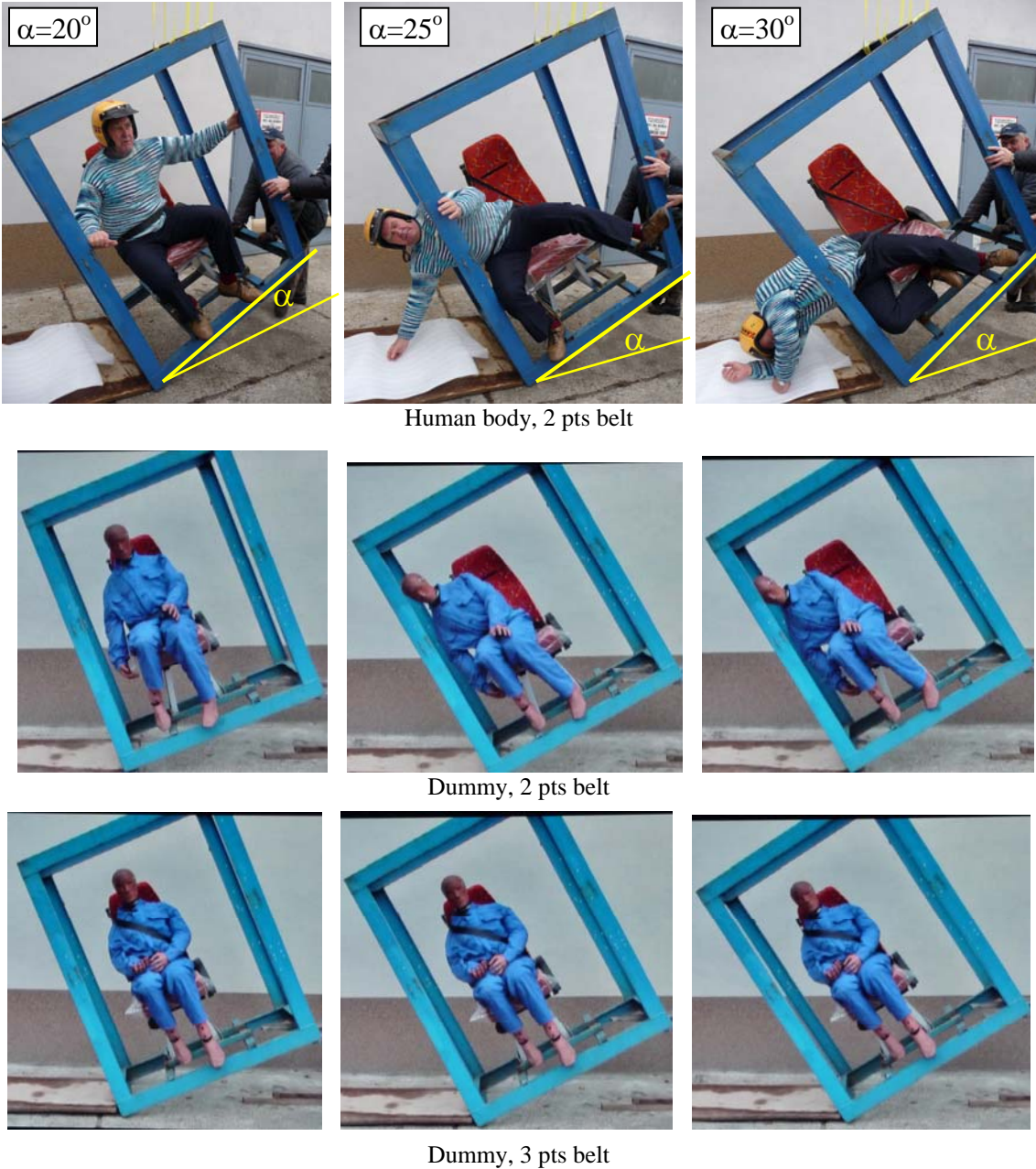

Figure 7. Different behaviour of the dummy and the human body in the tilting test.



Figure 8. Hanging dummy, 3 pts belt – no way to release the safety belt

The dummy – hanging on the 3 pts belt – created a very dangerous situation: the belt could not be released – as usual – by finger. Figure 8. shows the hanging position of the dummy, the release of the safety belt by a force transducer (380 N) and the dummy final position, lying on the ground. Figure 9. shows the final dummy positions with 3 pts and 2 pts belt. With 2 pts belt the dummy had larger displacement, its upper part – through its head – was supported somehow by the ground, therefore not the total mass was hanging on the seat belt. The belt release force is smaller in this case (310 N), but also unacceptable high for finger operation. For empty seat, when the belt is not loaded, the releasing force was 29 N, one order less than with loaded by hanging dummies.



Figure 9. 3 pts and 2 pts belted dummies in final position

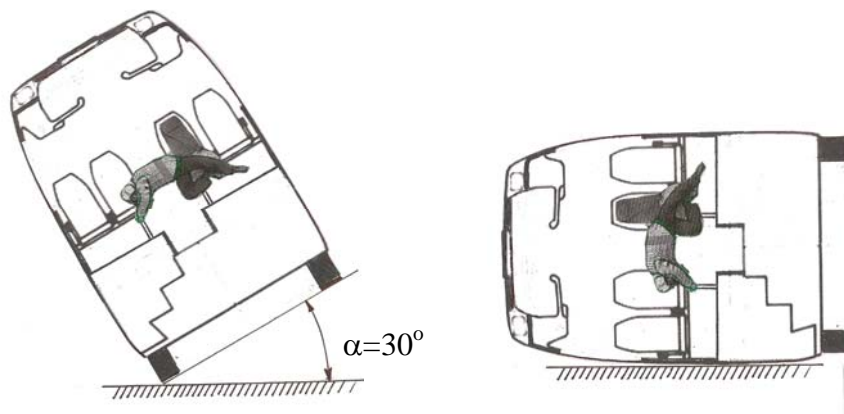

Figure 10. Hanging passengers in a bus which is lying on its side.

Another important result of these tests was, that the Hybrid III dummies are not suitable to study the passenger's (human body) real behaviour in rollover. The dummy is too rigid in crosswise direction, it behaves as a rigid body. The neck, the shoulders, the hip, etc. do not

have the necessary flexibility, motion capability. Many studies, computer simulations were published based on these dummies. [15], [16]. The results of these studies are questionable in some respect, where the flexibility of the human body was not considered.

This test series highlighted another, new problem to be considered: the passengers hanging on their seat belts cannot release the loaded belt, cannot leave the bus, the bus cannot be evacuated. If they could release the belt – e.g. cutting it – they would fall down onto the passengers having position below them, which also would not make easier the evacuation. Hanging on the safety belt, trying to release it and in the same time to hold their wait by grasping: this is not an easy task. This situation could be fatal if a fire breaks out after the rollover accident. Table I. shows that it could happen and this is one of the most dangerous accident situations in respect to the fatality and casualty rates. But this hanging position is very disadvantageous if there is no fire. The passengers can not help each other, there is no way to help the injured persons to leave the bus through the rear wall window, roof hatches or windscreen. Figure 10. illustrates the situation at tilting angle  $\alpha = 30^\circ$ , and we do not have any idea about the passenger's position at  $\alpha = 90^\circ$  (when the bus is lying on its side)

Figure 11. shows the driver dummy in original and in final position after  $3 \frac{1}{4}$  rotations in the VOLVO test, using 3 pts belt [9].



Figure 11. Original and final position of the “driver” in the VOLVO rollover test.

#### LAMINATED GLAZING AND EMERGENCY SIDE WINDOWS

One of the major objection against the use of laminated glazing in side windows is that it would drastically reduce the safety, because this solution prevents the use of the most popular emergency exit, the breakable side windows. To see clearly in this subject: three questions should be study and discussed:

- the emergency exits in general
- the role of the side windows in different emergency situations
- the usability of breakable side windows

#### Emergency exits in general

The following exits may be considered as emergency exit on buses:

service doors	side windows
emergency door	escape hatches
rear window	windscreen

There are four basic past-accident situations, when the bus has to be evacuated as quick as possible:

- the bus is standing on its wheels (after frontal, rear and side collisions, normal fire, rollover after one complete rotation)
- the bus is lying on it side (rollover, turned on its left or right side), this means two positions
- the bus is standing on its roof (rollover, half rotation)

General requirement is to have at least two well usable emergency exits in every basic past accident situation [13], because if one of them is blocked by any reason, the other one could be enough to evacuate the bus in time.

#### The role of emergency side windows

In the light of the above said, let us examine the role and necessity of side windows in emergency situations.

**When the bus is standing on its wheels** (Figure 12.): usable emergency exits are two service doors and one emergency door (One door is more than enough to evacuate the bus). There is no need for emergency side windows!



Figure 12. The bus is standing on its wheels

**When the bus is lying on its side** (Figure 13.): usable emergency exits are the escape hatches and the rear window, or possibly the windscreen. Side windows on one side are blocked by the ground, on the other side it is impossible to break the windows above the head and climb up through the window. There is no need for emergency windows!



Figure 13. The bus lying on its side

**The bus is standing on its roof** (Figure 14). The doors (both service and emergency doors) can be used also the rear window and windscreen. There is no need for emergency side windows!



Figure 14. The bus standing of its roof

### Usability of breakable side windows

Interesting test was carried out in UK [14], when the UN-ECE Regulation 36. (General safety provisions of large buses) was discussed. 100 voluntary elderly people (average of 73 years) were asked to simulate an emergency evacuation of a bus through side window. The test arrangement is shown on Figure 15. The participants knew the task, they knew what to do, there was no glass in the window frame (nothing to break) and 44% refused to pass the test, they were unable to exit through the window simulation. It has to be pointed out that it was a very “lightened” test: in real bus constructions the inside height of the side wall is 700-800 mm (instead of 500 mm), and the outside height is 1600-1800 mm (instead of 950 mm)

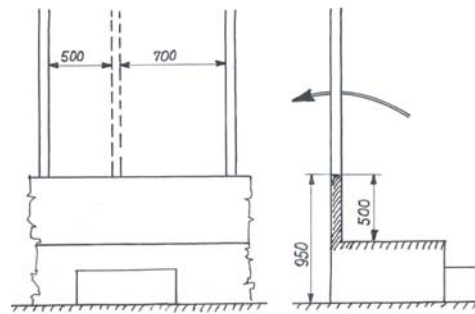

Figure 15. The use of breakable side emergency window

We also made evacuation test with breakable side window [13]. 30 years old woman – using protection gloves and face protective mask – was asked to leave the bus through a breakable side window. The measured time was:

- |  |      |
|--|------|
| - finding and getting the hammer                           | 15 s |
| - creating a “fire exit” with appropriate size, additional | 25 s |
| - leaving the bus with massive outside help, additional    | 50 s |
| altogether   | 90 s |

The massive outside help meant that two men lifted her out, she could not grasp the window pillar, she could not touch the window rail (waist rail) because of the sharp glass fragments (see Figure 16).



Figure 16. Arrangement of evacuation test through side window

The above said proves that there is no essential need for the emergency side windows, and if they are breakable emergency exits, they are unusable for average passengers. This recogni-

tion weakens the argument against the laminated safety glazing, because its use do not decrease, but strongly increase the passenger's safety in rollover accident. And one more argument: if – in special cases, like small buses or the lower passenger compartment in a double deck bus – there is a need for side wall emergency window, there are good, approved technical solutions, like hinged type, or “kick out” type window. UN-ECE Regulation 107 (General safety provisions of buses) considers and allows the use of these kind of emergency side windows.

But it has to be underlined that the laminated glazing – even it could be a big step to prevent or significantly reduce the casualties coming from ejection, gash and prick, cannot help against the projections. A general reconsideration is needed, how to increase the passive safety of bus passengers in all kind of accident situations and an optimum protection level should be specified.

## SUMMARY, CONCLUSIONS

- Solving the problem of the strength of bus superstructures, the severity of the injury mechanism **intrusion** (compression) has been drastically reduced, now the second most dangerous injury mechanism is the **ejection**, both total and partial ejection.
- There is no one technical solution which could prevent all the known injury mechanisms in rollover accident.
- It was believed that the safety belt could be a good solution for both the complete and partial ejections. Preliminary tests, shown in this paper prove, that it is not true and the safety belt can introduce a new problem, blocking the evacuation of the bus. The passengers hanging on the belt cannot release it.
- The laminated glazing side windows should not be excluded from the possible solutions preventing the ejection.
- When simulating the passenger's behaviour and motion in rollover (either in test or in computer simulation), the Hybrid III dummies are unusable, they do not represent the human body in this situation, in this process. They are too rigid in cross-wise direction, their flexibility does not represent the human body.
- The passive safety problems of the bus passengers need a new reconsideration involving all kind of bus accident situations.

## LIST OF REFERENCES

- (1) Conclusions of a severe accident. Informal document, No. GRSG-102-03, (2012). Submitted by Hungary. Homepage of UN-ECE: [www.unece.org/trans/main/welcwp29.html](http://www.unece.org/trans/main/welcwp29.html)
- (2) Matolcsy, M. In-depth analysis of a severe bus rollover accident (Was it really a severe one?) EAEC Congress 2007. Budapest. Paper No.CV 01-3 p.11 Proceedings on CD.
- (3) Rollover accident with ejection of occupants. Informal document, No. GRSG-91-07. (2006). Presented by Hungary. Homepage of UN-ECE.
- (4) Matolcsy, M. Analysis of bus accident statistics. FISITA Congress (2010), Budapest, Paper No. F2010 F001 ps.16.

- (5) Albertson P. et al. Case study: 128 in rollover coach crash in Sweden. Injury outcome, mechanisms and possible effects of seat belts. *Safety Science* 44 (2006), ps. 87-109.
- (6) ECBOS Summary Report (2004). Project of the European Commission, 5th Framework, project number 1999-RD, 11130. Presented also in UN-ECE/ WP.29/GRSG, where the reference number is: GRSG-86-4.
- (7) Matolcsy, M. Standard accident as the basis of vehicle approval test. EAEC Congress, (2001). Bratislava, B01, Section Safety, Paper No.SAITS 01122, ps.10.
- (8) Matolcsy, M. The effect of safety belts in bus rollover process. IMechE publication, Paper No. C601/001/2002, ps. 10.
- (9) Presson H, - Forlund B. Rollover protection of buses and coaches – VOLVO experience. 33<sup>rd</sup> meeting of Bus and Coach Experts. Keszthely, GTE (2002) Session 3; Passive Safety. Paper No. 309a Proceedings on CD
- (10) Martinez et al. Effectiveness of restraint systems in bus rollover. 33<sup>rd</sup> Meeting of Bus and Coach Expert. Keszthely GTE (2002) Session 3; Passive Safety. Paper No. 311a. Proceedings on CD
- (11) Laminated safety glassing as side windows on buses. Informal document, (2005). Reference number: GRSG-89-010. Presented by Hungary and Sweden in UN-ECE/ WP.29/GRSG
- (12) Matolcsy, M. Analysis of bus fires and belonging safety questions. EAEC Congress, (2009). Bratislava, Safety Section, ps. 12. Proceedings on CD.
- (13) Matolcsy, M. Evacuation of buses – Emergency exits. Conf. on Science and Vehicle, Belgrade, (2011). Reference No. SAFO3 ps. 13.
- (14) Investigation into the ability of elderly people in climbing out of simulated bus emergency exits. Project Report (March, 1974). Industrial Ergonomics, Cranfield Institute of Technology, UK. Manuscript.
- (15) Ruiz S.- Millanes M. A contribution to the discussion of the passengers influence in the ECE R.60 rollover test. 33<sup>rd</sup> Meeting of Bus and Coach Experts. Keszthely, GTE (2002) Session 3, Passive Safety. Proceeding on CD. Ps. 5.
- (16) Cheng L.Y. et al: Heavy truck crashworthiness – 30° rollover accident. 15<sup>th</sup> ESV Conference (1996). Paper No. 96-S11-0-14. ps. 11.